

WATER CHANGES THE WAY

WE SEE THE WORLD.



MOEN[®]

Contents



Nio Pulldown **NEW!**

INNOVATION AND STYLE

- 26 MotionSense Wave™
- 54 M•PACT® Common Valve System
- 54 Pro-Fit® Installation
- 55 Roman Tub Valves
- 111 Doux™ in Matte Black **NEW!**
- 278 U by Moen™ Showering
- 359 Bath Safety

SUGGESTED LIST PRICES

- 2 Wholesale

HANDS-FREE KITCHEN

Styles with MotionSense™

- 28 STō®
- 28 Align®
- 28 Brantford®
- 28 Arbor®

Styles with MotionSense Wave™

- 29 Align® Spring **NEW!**
- 29 Brantford® **NEW!**
- 29 Arbor®
- 29 Sleek™

Kitchen and Bar Collections

- 30 Waterhill®
- 31 Weymouth®
- 31 90°™
- NEW!** 31 Nio™
- 32 STō®
- NEW!** 32 Paterson™
- 32 Etch™
- 33 Aberdeen™
- 33 Woodmere®
- 33 Tilt™
- 33 Voss™
- 33 Notch™
- 34 Align®
- 35 Riley™
- 35 Brantford™
- 36 Genta™
- 38 Arbor®
- 38 Camerist®
- 39 Sleek™
- 39 Method™
- 39 Belfield™
- 40 Chateau®
- 41 Moen II®
- 43 Pot Fillers
- 44 Bar/Prep Faucets
- 48 Laundry Faucets
- 49 Beverage and Filtering Faucets
- 51 Soap/Lotion Dispensers,
Hose Management

Bath and Shower Collections

- 56 Weymouth®
- 69 Arris®
- 81 Waterhill®
- 89 90°™
- 103 Via™
- NEW!** 111 Doux™
- 123 Rothbury™
- 136 Icon™
- 147 Wynford™
- 160 Align®
- 174 Voss™
- NEW!** 189 Kyvos™
- 194 Belfield™
- 207 Kingsley®
- 219 Rizon™
- 226 Dartmoor™
- 232 Glyde™
- 238 Brantford™
- 248 Eva®
- 257 Vichy™
- 262 Method™
- 269 Chateau®
- 275 Moen II®

Shower and Bath Custom Options

- 278 U by Moen™
- 284 ExactTemp® 3/4" Thermostatic Showering
- 292 Moentrol® Multi-Function Showering Options
- 299 Moentrol® and Standard Transfer Valve Showering Components
- 309 Posi-Temp® and Standard Transfer Valve Showering Components
- 329 Showerheads
- 337 Handheld Showers
- 344 Handheld Shower Accessories
- 345 Body Sprays
- 346 Shower Arms and Flanges
- 348 Showering Accessories
- 349 Tub Spouts and Drains

Coordinating Bath Accessories

- 358 Curved Shower Rods
- 359 Bath Safety

Moen Genuine Parts

- 363 Genuine Replacement Parts

M-Line

- 373 M-Line Parts

Commercial

- 377 Faucets and Valves

Wholesale

Listed in numerical order

MODEL NUMBER	LIST PRICE	PAGE NO.	UNIVERSAL PRODUCT CODE	CASE QTY
2-102-5BS	26.80	358	34584003539	25
2-102-5PS	24.35	358	34584003522	25
65-F-BS	19.85	358	34584003553	25
65-F-PS	17.95	358	34584003546	25
117	7.05	365	26508001172	72
162	121.35	370	26508043349	6
395	1,768.30	161	26508298367	1
395BG	2,554.70	161	26508298374	1
395BL	2,554.70	161	26508298381	1
395BN	2,554.70	161	26508298398	1
601	41.90	50	26508072158	12
655	1,821.70	149	26508298404	1
655BN	2,692.25	149	26508298411	1
655NL	2,692.25	149	26508298428	1
655ORB	2,692.25	149	26508298435	1
695	1,821.70	176	26508280973	0
695BG	2,692.25	176	26508290415	1
695BN	2,692.25	176	26508280980	1
695NL	2,692.25	176	26508290422	1
695ORB	2,692.25	176	26508280997	1
1200	52.20	364	26508012000	36
1200B	51.95	364	26508005019	144
1222	117.60	364	26508014004	18
1222B	114.90	364	26508043868	72
1224	22.35	364	26508012246	36
1224B	20.60	364	26508004609	144
1225	42.40	364	26508012253	36
1225B	40.65	364	26508004616	144
1234	20.60	364	26508251669	1
1248	22.35	364	26508004623	18
1248B	20.75	364	26508043226	144
1255	40.65	364	26508199022	72
1258	20.60	364	26508251676	18
2353	236.90	273	26508025697	12
2510	152.20	100	26508074541	6
2520	152.20	100	26508073001	6
2570	194.75	100	26508073018	6
2590	194.75	100	26508073025	6
3233EP	121.10	333	26508219430	12
3233EPBN	172.05	333	26508219447	12
3320	352.60	125	26508081761	6
3330	352.60	125	26508081754	6
3350	352.60	125	26508228227	6
3360	216.60	443	26508222768	6
3362	215.60	106	26508284568	6
3372	188.30	106	26508201930	12
3375	188.30	106	26508228234	12
3510	210.05	117	26508102336	6
3520	210.05	117	26508102329	6
3558EP	326.55	340	26508282274	6
3558EPBL	745.45	340	26508285442	6
3558EPBN	745.45	340	26508282281	6
3558EPORB	745.45	340	26508282298	6
3570	232.40	117	26508072981	6
3636EP	265.90	340	26508241677	6
3636EPBN	618.05	340	26508241684	6
3636EPORB	618.05	340	26508242773	6
3638	125.80	333	26508241691	12
3638BN	178.75	333	26508241707	12
3638EP	125.80	333	26508242131	12
3638EPBN	178.75	333	26508242148	12
3638ORB	178.75	333	26508242155	12
3662EP	255.45	337	26508279861	6
3662EPBN	378.50	337	26508279878	6
3662EPORB	378.50	337	26508279885	6
3667EP	326.55	338	26508242162	6
3667EPBN	745.45	338	26508242179	6

MODEL NUMBER	LIST PRICE	PAGE NO.	UNIVERSAL PRODUCT CODE	CASE QTY
3667EPNL	745.45	338	26508301197	6
3667EPORB	745.45	338	26508242186	6
3668EP	265.60	340	26508242193	6
3668EPBN	432.20	340	26508242209	6
3668EPORB	432.20	340	26508242216	6
3669EP	326.55	339	26508242223	6
3669EPBL	745.45	339	26508290187	-
3669EPBN	745.45	339	26508242230	6
3669EPORB	745.45	339	26508242247	6
3800	58.50	351	26508030639	12
3801	59.85	351	26508029473	12
3803P	168.40	350	26508030691	12
3804	46.65	354	26508030707	12
3805	46.65	354	26508008614	12
3806	95.55	350	26508041680	12
3807	94.40	350	26508041710	12
3807BN	140.90	350	26508138434	12
3807CP	106.75	350	26508041734	12
3808	77.10	351	26508118252	12
3808BN	132.55	351	26508118283	12
3808ORB	127.75	351	26508113523	12
3808P	140.90	351	26508118276	12
3808WR	132.55	351	26508118290	12
3809BN	110.10	350	26508131800	12
3828	58.85	354	26508133736	12
3829	58.85	354	26508133743	12
3829BC	98.25	354	26508149393	12
3829BN	142.20	354	26508133804	12
3829ORB	142.20	354	26508134375	12
3839	72.65	352	26508239490	12
3839BN	127.80	352	26508260203	1
3853	72.65	352	26508070345	12
3853BN	127.80	352	26508164518	12
3853ORB	127.80	352	26508164525	12
3857	86.00	350	26508070406	6
3857BN	139.25	350	26508162453	6
3857ORB	139.25	350	26508162460	6
3858	82.25	353	26508162477	6
3858BN	126.75	353	26508162484	6
3858ORB	126.75	353	26508162491	6
3861EP	364.55	341	26508219508	6
3861EPBN	648.60	341	26508219515	6
3861EPNL	648.60	341	26508250969	6
3861EPORB	648.60	341	26508219522	6
3863EP	326.55	339	26508219539	6
3863EPBN	745.45	339	26508219546	6
3865EP	216.70	341	26508221495	6
3865EPBN	353.70	341	26508221501	6
3865EPORB	353.70	341	26508227619	6
3868EP	265.60	340	26508221532	6
3868EPBG	432.20	340	26508285176	6
3868EPBN	432.20	340	26508221549	6
3868EPORB	432.20	340	26508227633	6
3869EP	426.80	338	26508222140	6
3869EPBN	745.45	338	26508223222	6
3869EPORB	745.45	338	26508223215	6
3869EPWR	745.45	338	26508250709	6
3887EP	352.95	339	26508222157	6
3887EPBG	745.45	339	26508285183	6
3887EPBL	745.45	339	26508283509	6
3887EPBN	745.45	339	26508223239	6
3890	94.40	350	26508174746	12
3890BN	135.85	350	26508174753	12
3892	87.05	354	26508174760	12
3892BG	124.80	354	26508285602	6
3892BN	124.80	354	26508174777	12
3911	61.30	352	26508004258	12

MODEL NUMBER	LIST PRICE	PAGE NO.	UNIVERSAL PRODUCT CODE	CASE QTY	MODEL NUMBER	LIST PRICE	PAGE NO.	UNIVERSAL PRODUCT CODE	CASE QTY
3919	16.70	368	26508039199	18	6102BN	539.50	207	26508128893	3
3924	16.70	368	26508039243	18	6102ORB	539.50	207	26508131961	3
3926	52.05	352	26508004272	12	6102WR	539.50	207	26508128909	3
3929BC	94.75	351	26508137284	12	6121	356.55	207	26508126745	3
3931	37.30	352	26508004289	12	6121BN	575.35	207	26508126769	3
3942	111.25	52	26508187586	6	6121ORB	575.35	207	26508131978	3
3942BL	133.90	52	26508187890	6	6121WR	575.35	207	26508126776	3
3942SRS	133.90	52	26508234341	6	6124C	489.50	46	26508254608	3
3942W	133.90	52	26508187913	6	6124ORB	665.65	46	26508254615	3
3944	111.25	52	26508187616	6	6124SRS	665.65	46	26508254622	3
3944BL	133.90	52	26508289907	-	6172	231.10	232	26508261163	3
3944ORB	133.90	52	26508187937	6	6172BN	330.90	232	26508261170	3
3944SRS	133.90	52	26508234358	6	6190	307.15	160	26508244913	3
3959	55.60	354	26508004296	12	6190BG	456.15	160	26508284674	3
3960	64.55	352	26508004302	12	6190BL	456.15	160	26508274989	3
3988EP	370.55	339	26508282304	6	6190BN	456.15	160	26508249567	3
3988EPBN	763.45	339	26508282328	6	6192	411.15	160	26508249611	3
3988EPNL	763.45	339	26508301203	6	6192BG	597.45	160	26508285947	3
3988EPORB	763.45	339	26508282342	6	6192BN	597.45	160	26508249628	3
4500	326.50	147	26508253649	3	6300	18.20	336	26508154724	12
4500BN	539.50	147	26508253656	3	6300BN	74.05	336	26508207574	12
4500NL	539.50	147	26508255650	3	6300EP15	18.20	336	26508241745	12
4500ORB	539.50	147	26508255667	3	6300EP	18.20	336	26508208557	12
4505	313.80	147	26508255674	3	6300EPBN	74.05	336	26508208571	12
4505BN	500.60	147	26508255681	3	6300P	74.05	336	26508154748	12
4505NL	500.60	147	26508255698	3	6302	113.70	333	26508142417	12
4505ORB	500.60	147	26508255704	3	6302BN	152.95	333	26508142431	12
4507	457.15	147	26508255711	3	6302EP	113.70	333	26508208595	12
4507BN	728.40	147	26508255728	3	6302EPBN	152.95	333	26508208625	12
4507ORB	728.40	147	26508255742	3	6302EPORB	152.95	333	26508208632	12
4791	282.65	189	26508273067	3	6302EPP	152.95	333	26508208649	12
4792	188.00	104	26508229583	6	6302ORB	152.95	333	26508142448	12
4796	179.95	104	26508229606	6	6302P	152.95	333	26508142462	12
4798	179.95	104	26508229620	6	6302WR	152.95	333	26508142486	12
4872	104.25	48	26508061756	12	6303	64.30	334	26508153314	12
4873	100.25	48	26508061763	12	6303BN	100.65	334	26508153321	12
4903	121.30	47	26508085325	12	6303EP	64.30	334	26508208687	12
4904	228.95	47	26508207505	3	6303EPBN	100.65	334	26508208694	12
4905	256.55	47	26508138748	3	6303EPORB	100.65	334	26508208700	12
4905ORB	359.90	47	26508164884	3	6303ORB	100.65	334	26508153338	12
4905SRS	359.90	47	26508242902	3	6304	25.25	336	26508156223	12
4925	176.00	269	26508002360	12	6304EP	25.25	336	26508208717	12
4925BC	210.10	269	26508136737	12	6313	64.30	334	26508214862	12
4945	345.95	269	26508002537	6	6313BN	100.65	334	26508214879	12
4962	321.50	269	26508006009	6	6313ORB	100.65	334	26508214886	12
5263	69.40	439	26508237212	12	6322	93.25	335	26508239506	12
5263CBN	125.15	439	26508237229	12	6322BL	131.15	335	26508290095	12
5263EP15	69.40	439	26508237236	12	6322BN	131.15	335	26508260210	1
5263EP15CBN	125.15	439	26508237243	12	6322EP	93.25	335	26508239513	12
5923	582.45	34	26508267028	3	6322EPBL	131.15	335	26508290101	12
5923BL	753.85	34	26508282557	3	6322EPBN	131.15	335	26508260227	1
5923EWBL	852.60	29	26508291054	3	6325	113.70	334	26508230107	12
5923EWC	743.90	29	26508279007	3	6325BG	152.95	334	26508285251	12
5923EWSRS	852.60	29	26508279014	3	6325BN	152.95	334	26508230114	12
5923SRS	753.85	34	26508267035	3	6325EP	113.70	334	26508230121	12
5965	474.85	46	26508240007	3	6325EPBG	152.95	334	26508285268	12
5965BG	615.90	46	26508283851	3	6325EPBN	152.95	334	26508230138	12
5965BL	615.90	46	26508282564	3	6325EPNL	152.95	334	26508301210	-
5965SRS	615.90	46	26508240014	3	6325EPORB	152.95	334	26508230145	12
5985	461.75	46	26508211748	3	6325NL	152.95	334	26508301227	-
5985ORB	596.05	46	26508211809	3	6325ORB	152.95	334	26508230152	12
5985SRS	596.05	46	26508242926	3	6345	122.55	331	26508238554	3
5995	461.75	46	26508207291	3	6345BN	173.20	331	26508271469	3
5995BL	596.05	46	26508228395	3	6345ORB	173.20	331	26508271476	3
5995ORB	596.05	46	26508209790	3	6370	70.75	335	26508266632	12
5995SRS	596.05	46	26508231968	3	6370BN	110.65	335	26508266687	12
6102	326.50	207	26508128886	3	6370EP	70.75	335	26508281840	12

Wholesale

Listed in numerical order

MODEL NUMBER	LIST PRICE	PAGE NO.	UNIVERSAL PRODUCT CODE	CASE QTY
6370EPBN	110.65	335	26508281796	3
6371	70.75	335	26508266625	12
6371BN	110.65	335	26508266649	12
6371EP	70.75	335	26508281802	12
6371EPBN	110.65	335	26508281819	12
6371EPORB	110.65	335	26508281826	12
6371ORB	110.65	335	26508266670	12
6399	93.25	334	26508174722	12
6399BG	128.80	334	26508285954	12
6399BL	128.80	170	26508275009	12
6399BN	128.80	334	26508174739	12
6399EP	93.25	334	26508208762	12
6399EPBG	128.80	334	26508285961	12
6399EPBL	128.80	170	26508275023	12
6399EPBN	128.80	334	26508208779	12
6400	281.20	248	26508195369	3
6400BN	394.45	248	26508195376	3
6400ORB	394.45	248	26508195383	3
6401	313.80	194	26508275337	3
6401BN	500.60	194	26508275344	3
6401NL	500.60	194	26508301234	-
6401ORB	500.60	194	26508275351	3
6402	326.50	194	26508275153	3
6402BN	539.50	194	26508275160	3
6402NL	539.50	194	26508301241	-
6402ORB	539.50	194	26508275177	3
6410	210.15	248	26508153109	6
6410BN	300.80	248	26508153116	6
6410ORB	300.80	248	26508153123	6
6600	281.20	238	26508195390	3
6600BN	394.45	238	26508195406	3
6600ORB	394.45	238	26508195413	3
6610	210.15	238	26508162057	6
6610BN	300.80	238	26508160992	6
6610ORB	300.80	238	26508161005	6
6710	249.80	257	26508273074	3
6781	325.00	189	26508288405	3
6802	231.10	226	26508264386	3
6802BN	330.90	226	26508264393	3
6802ORB	330.90	226	26508264409	3
6810	281.20	262	26508206959	3
6810BN	394.45	262	26508206966	3
6900	281.20	219	26508235096	3
6900BL	394.45	219	26508301258	-
6900BN	394.45	219	26508258293	3
6901	313.80	174	26508230169	3
6901BG	500.60	174	26508284629	3
6901BN	500.60	174	26508230176	3
6901NL	500.60	174	26508301265	-
6901ORB	500.60	174	26508230183	3
6903	326.50	174	26508230190	3
6903BG	539.50	174	26508284636	3
6903BN	539.50	174	26508230206	3
6903NL	539.50	174	26508297582	-
6903ORB	539.50	174	26508230213	3
6911	379.65	219	26508258309	3
6911BN	532.40	219	26508258316	3
7165	409.75	35	26508240021	3
7165SRS	538.85	35	26508240038	3
7185C	484.95	36	26508211786	3
7185EC	803.20	28	26508242308	3
7185EORB	884.05	28	26508242315	3
7185ESRS	884.05	28	26508242322	3
7185EWC	644.85	29	26508292686	3
7185EWORB	721.40	29	26508292693	3
7185EWSRS	721.40	29	26508292709	3
7185ORB	624.55	36	26508211816	3

MODEL NUMBER	LIST PRICE	PAGE NO.	UNIVERSAL PRODUCT CODE	CASE QTY
7185SRS	624.55	36	26508242940	3
7240C	327.40	39	26508259870	3
7240ORB	447.70	39	26508259887	3
7240SRS	447.70	39	26508259894	3
7245C	380.65	39	26508259900	3
7245ORB	520.60	39	26508259917	3
7245SRS	520.60	39	26508259924	3
7250C	309.50	40	26508259931	3
7250ORB	423.35	40	26508259948	3
7250SRS	423.35	40	26508259955	3
7255C	361.10	40	26508259962	3
7255ORB	492.20	40	26508259979	3
7255SRS	492.20	40	26508259986	3
7294BL	570.15	37	26508228838	3
7294C	473.20	37	26508228845	3
7294ORB	610.30	37	26508228869	3
7294SRS	610.30	37	26508231975	3
7295C	473.20	36	26508267158	3
7295ORB	610.30	36	26508267172	3
7295SRS	610.30	36	26508267165	3
7365	356.75	35	26508251171	3
7365SRS	470.10	35	26508251188	3
7402C	492.95	35	26508266793	3
7402SRS	632.85	35	26508266809	3
7423	190.70	40	26508053157	6
7425	185.50	40	26508052938	6
7430	232.00	40	26508052853	6
7434	232.00	40	26508053034	6
7545C	458.85	38	26508138816	3
7545ORB	585.40	38	26508164907	3
7545SRS	585.40	38	26508242964	3
7565	497.80	34	26508240045	3
7565BG	645.10	34	26508283868	3
7565BL	645.10	34	26508274736	3
7565EC	851.70	28	26508257944	3
7565ESRS	937.50	28	26508257951	3
7565SRS	645.10	34	26508240052	3
7585C	353.10	39	26508270318	3
7585SRS	481.25	39	26508270325	3
7590C	631.90	33	26508108543	2
7590CSL	844.55	33	26508198933	2
7590ORB	844.55	33	26508144312	2
7594BL	624.55	37	26508228388	3
7594C	484.95	37	26508205037	3
7594EC	803.20	28	26508233863	3
7594EORB	884.05	28	26508233870	3
7594ESRS	884.05	28	26508233887	3
7594EWBL	721.40	29	26508289914	3
7594EWC	644.85	29	26508279021	3
7594EWORB	721.40	29	26508279038	3
7594EWSRS	721.40	29	26508279045	3
7594ORB	624.55	37	26508209806	3
7594SRS	624.55	37	26508231982	3
7615C	618.65	33	26508267110	3
7615ORB	827.85	33	26508267134	3
7615SRS	827.85	33	26508267127	3
7626C	529.40	33	26508267059	3
7626SRS	718.30	33	26508267066	3
7790	401.15	38	26508207581	3
7790SRS	523.75	38	26508231999	3
7825	243.35	38	26508138786	3
7825ORB	364.60	38	26508164914	3
7825SRS	364.60	38	26508242988	3
7835	282.10	38	26508138809	3
7835SRS	405.90	38	26508242995	3
7840	282.10	38	26508138847	3
7840ORB	405.90	38	26508164938	3

MODEL NUMBER	LIST PRICE	PAGE NO.	UNIVERSAL PRODUCT CODE	CASE QTY	MODEL NUMBER	LIST PRICE	PAGE NO.	UNIVERSAL PRODUCT CODE	CASE QTY
7840SRS	405.90	38	26508243008	3	8290EP15	161.10	439	26508213360	12
7864	449.55	39	26508278444	3	8310	853.05	420	26508006412	4
7864BL	580.90	39	26508278451	3	8310AC16	853.05	420	26508167649	4
7864EWBL	677.75	29	26508289921	3	8310ACDF16	895.75	420	26508205969	4
7864EWC	609.45	29	26508279052	3	8310BPW16	769.15	426	26508242261	2
7864EWSRS	677.75	29	26508279069	3	8310BPW35	769.15	426	26508242254	2
7864SRS	580.90	39	26508278468	3	8310BPWR	555.00	426	26508240151	3
7882	481.35	36	26508279311	3	8310DF16	895.75	420	26508205976	4
7882BL	616.55	36	26508289938	3	8310M16	258.10	425	26508236536	3
7882SRS	616.55	36	26508279328	3	8310M35	258.10	425	26508236543	3
7906	154.25	41	26508003398	6	8310M128	258.10	425	26508236529	3
7907	192.10	41	26508030318	6	8310MR16	209.95	426	26508239216	6
7910	160.60	41	26508004142	12	8310MR35	209.95	426	26508236567	6
8103	201.75	396	26508162309	6	8310MR128	209.95	426	26508236550	6
8106	288.30	396	26508162323	6	8310R16	764.25	422	26508160329	8
8113	305.05	396	26508162279	6	8310RDF16	806.95	422	26508205983	4
8116	391.55	396	26508162316	6	8310S35	853.05	420	26508265123	3
8119	395.15	394	26508162330	6	8310SR128	764.25	422	26508265178	3
8121	287.30	394	26508025208	6	8311	853.05	420	26508199077	4
8124	391.60	395	26508026168	6	8311AC12	853.05	420	26508199091	4
8125	216.95	393	26508026182	6	8312	853.05	420	26508152225	4
8126	371.40	394	26508162347	6	8312AC10	853.05	421	26508167656	4
8137	281.30	393	26508185476	6	8312M0125	258.10	425	26508236574	3
8198	78.05	395	26508140680	10	8312M05	258.10	425	26508236581	3
8199	53.15	395	26508140697	10	8312M10	258.10	425	26508236598	3
8210	236.05	384	26508153789	6	8312MR0125	209.95	426	26508236604	6
8210F05	236.05	384	26508235430	6	8312MR05	209.95	426	26508236611	6
8210F12	236.05	384	26508266847	6	8312MR10	209.95	426	26508236628	6
8210SMF12	236.05	398	26508266854	6	8312R10	764.25	422	26508160305	8
8215	258.80	385	26508161180	6	8312SR05	764.25	422	26508265260	3
8215F03	258.80	385	26508235447	6	8312SR125	764.25	422	26508265284	3
8215F05	258.80	385	26508235454	6	8314	853.05	421	26508152232	6
8215F12	258.80	385	26508266946	6	8314M10	258.10	425	26508236642	3
8215SMF12	258.80	398	26508266830	6	8315	853.05	420	26508199084	4
8216	281.45	384	26508014172	6	8315AC05	853.05	421	26508199107	4
8219	304.15	385	26508167786	6	8316	853.05	420	26508205990	4
8220	388.60	385	26508015964	6	8316AC	853.05	421	26508213223	4
8220F05	388.60	385	26508235508	3	8349	87.80	438	26508015094	6
8223	434.25	385	26508155417	6	8349CBN	148.65	438	26508237038	6
8225	416.05	388	26508162439	6	8349EP15	87.80	438	26508213391	6
8225SMF15	415.90	397	26508238684	3	8349EP15CBN	148.65	438	26508237045	6
8226	305.50	388	26508155431	6	8413	228.05	386	26508129715	6
8227	392.50	388	26508162255	6	8413F03	228.05	386	26508234440	3
8228	410.65	386	26508161197	6	8413F05	228.05	386	26508234457	3
8228F05	410.65	386	26508235522	3	8413F12	228.05	386	26508266564	3
8228F12	410.65	386	26508266823	3	8414	276.15	386	26508137123	6
8229	330.20	388	26508162262	6	8416	249.50	387	26508017272	6
8230	270.05	394	26508172179	3	8416F05	249.50	387	26508234471	3
8239	454.80	386	26508015971	6	8417	280.70	387	26508129722	6
8244	453.70	389	26508185490	6	8417F05	280.70	387	26508234495	6
8248	406.35	389	26508181089	6	8417F12	280.70	387	26508266571	6
8248SMF12	406.35	397	26508267073	3	8418	300.50	387	26508150801	6
8270	288.50	392	26508154618	6	8419F05	337.85	387	26508227848	6
8272	298.90	392	26508154625	6	8419F12	337.85	387	26508266588	6
8274	219.75	392	26508155448	6	8422	232.70	406	26508232125	12
8276	229.45	392	26508167717	6	8422F05	232.70	406	26508232149	12
8278	297.10	392	26508167809	6	8430	177.00	406	26508066454	12
8278SMF12	297.10	397	26508267080	6	8430CBN	221.85	406	26508235348	12
8279	303.00	392	26508167816	6	8430F05	177.00	406	26508232156	12
8279SMF12	303.00	398	26508267097	6	8437CBN	298.35	406	26508235355	-
8280	238.50	390	26508154632	6	8551	784.15	415	26508249901	6
8282	353.30	390	26508205525	6	8551AC	845.70	415	26508249918	6
8283	326.35	390	26508205532	6	8552	923.75	415	26508249925	6
8285	265.55	390	26508161203	6	8552AC	992.65	415	26508249932	6
8287	324.25	390	26508162231	6	8553	784.15	416	26508249949	6
8289	351.30	390	26508162248	6	8553AC	845.70	416	26508249956	6
8290	161.10	439	26508154069	12	8554	923.75	416	26508249963	6

Wholesale

Listed in numerical order

MODEL NUMBER	LIST PRICE	PAGE NO.	UNIVERSAL PRODUCT CODE	CASE QTY
8554AC	992.65	416	26508249970	6
8558	672.40	412	26508271995	3
8559	840.05	412	26508271483	6
8560	672.40	412	26508272008	3
8562	1,031.00	413	26508271490	3
8565	820.80	413	26508271506	3
8701	244.10	391	26508129739	12
8707	276.40	391	26508206515	-
8711	270.40	391	26508020289	6
8713	558.25	391	26508020951	12
8714	566.05	391	26508015933	12
8717	303.65	391	26508237649	6
8780	163.65	407	26508021859	6
8792	293.30	408	26508125717	6
8798	256.10	407	26508003930	6
8799	321.10	408	26508013779	6
8800	210.05	406	26508007778	6
8800F05	210.05	406	26508235317	6
8884	232.75	401	26508093238	6
8886	412.50	402	26508093245	6
8889	496.20	402	26508093252	6
8894	275.25	402	26508220672	6
8938	222.90	409	26508003954	6
8940	286.60	410	26508013762	6
8948	208.20	410	26508061695	6
8957	183.15	409	26508030264	12
9000	148.70	103	26508081112	6
9001	111.20	50	26508094709	6
9025	1,821.70	195	26508298442	1
9025BN	2,692.25	195	26508298459	-
9025NL	2,692.25	195	26508298466	-
9025ORB	2,692.25	195	26508298473	-
9124C	515.75	33	26508254639	3
9124ORB	696.00	33	26508254646	3
9124SRS	696.00	33	26508254653	3
9125C	508.70	33	26508254325	3
9125ORB	686.55	33	26508254332	3
9125SRS	686.55	33	26508254349	3
9220F05	428.15	384	26508255391	3
9220F12	428.15	384	26508266953	3
9223F05	475.65	384	26508257302	3
9223F12	475.65	384	26508266960	3
9263	95.15	439	26508255421	12
9263EP15	95.15	439	26508255438	12
9265	319.85	158	26508255155	6
9349	140.00	438	26508255445	6
9349EP15	140.00	438	26508255452	6
9417F05	347.30	383	26508257296	3
9417F12	347.30	383	26508266977	3
9419F05	385.85	383	26508255483	3
9419F12	385.85	383	26508266984	3
9480	216.25	405	26508255490	3
9482	239.60	405	26508255506	3
9601	62.90	50	26508153918	18
9700	219.75	175	26508230008	3
9796	358.95	114	26508229651	6
9797	358.95	114	26508229668	6
9921	321.20	405	26508255513	3
9922	361.15	405	26508255520	3
10066	28.50	372	26508037836	125
10066BN	41.00	372	26508117088	20
10066P	41.00	372	26508039892	0
10066WR	41.00	372	26508117095	20
10154	12.80	347	26508050903	50
10154BG	32.85	347	26508285213	30
10154BN	32.85	347	26508105344	50
10154NL	32.85	347	26508104248	0

MODEL NUMBER	LIST PRICE	PAGE NO.	UNIVERSAL PRODUCT CODE	CASE QTY
10154ORB	32.85	347	26508100325	50
10154P	32.85	347	26508052051	0
10154SLP	32.85	347	26508122068	20
10154WR	32.85	347	26508117101	20
10399	59.50	371	26508033197	36
10510	28.50	372	26508037829	30
10709	14.65	369	26508027226	84
10709BC	20.50	369	26508172247	20
10709BN	50.70	369	26508172254	20
10709ORB	50.70	369	26508172261	20
10709WR	50.70	369	26508172308	50
10790	90.55	369	26508004166	12
10927	46.90	366	26508034163	30
13382	12.50	366	26508028834	300
14272	7.25	365	26508031087	150
14526	55.40	369	26508028308	0
14891	20.75	364	26508148914	60
15440	688.00	417	26508245699	2
15856	58.40	441	26508015186	12
15856CBN	117.55	441	26508239858	12
15972	22.65	372	26508014523	24
20200	43.10	368	26508202005	18
26100EP	93.40	337	26508266540	2
26100EPSRN	115.25	337	26508266557	2
52016	21.95	367	26508165065	-
52016F05	16.45	418	26508236284	100
52016F10	16.45	418	26508228708	24
52100	138.50	403	26508207635	24
52120	312.35	386	26508207048	12
52224GBM15	375.40	436	26508226964	3
52224GBM25	375.40	436	26508226995	3
52236GBM15	410.70	437	26508227015	3
52236GBM25	410.70	437	26508227046	3
52652	18.35	399	26508036198	24
52653	17.50	399	26508029336	24
52655	18.35	399	26508029510	24
52703	78.85	441	26508026083	12
52710	307.05	437	26508063361	6
52710EP15	307.05	437	26508213346	6
52710EP15CBN	714.15	437	26508237144	6
52711	34.60	441	26508228630	12
52716EP15	85.85	439	26508213353	20
72964	98.45	276	26508000816	12
74960	94.20	275	26508121818	12
74961	94.20	275	26508121825	12
74962	94.20	275	26508121832	12
77922	109.45	41	26508121764	12
77924	109.45	41	26508121788	12
77925	109.45	41	26508121795	12
77926	109.45	41	26508121801	12
91751	12.75	366	26508023655	1000
94514	13.55	366	26508021316	150
96365	4.40	365	26508963654	36
96497	68.65	369	26508004708	12
96778	10.55	365	26508967782	36
96790	33.55	366	26508009048	1
96791	33.55	366	26508009055	150
96797	33.55	366	26508009062	150
96858	82.85	370	26508014486	0
96868	92.80	370	26508014509	0
96914	6.80	365	26508030998	500
96945	56.70	370	26508017609	100
96945BN	89.30	370	26508120361	9
96945WR	89.45	370	26508118337	9
96955	57.20	370	26508017616	1
96987	13.05	372	26508028001	20
96987BN	23.75	372	26508118344	20

MODEL NUMBER	LIST PRICE	PAGE NO.	UNIVERSAL PRODUCT CODE	CASE QTY	MODEL NUMBER	LIST PRICE	PAGE NO.	UNIVERSAL PRODUCT CODE	CASE QTY
96987WR	23.75	372	26508118351	20	104580	48.30	423	26508244111	12
96988	22.80	365	26508017586	100	104581	49.25	423	26508244128	20
97082	108.50	276	26508000861	6	104582	46.40	423	26508246832	20
97092	108.50	276	26508000878	6	104583	40.60	423	26508246856	20
99503	81.15	371	26508020401	0	104584	108.95	423	26508247877	12
99550	36.60	401	26508207659	12	104585	140.70	423	26508247884	0
99551	37.30	402	26508220689	12	104587	211.15	423	26508248614	6
99556	55.50	415	26508252130	20	104588	36.50	423	26508246863	20
99557	55.50	416	26508252147	20	104589	50.75	423	26508246870	20
99558	71.55	412	26508252154	20	104590	33.40	427	26508247426	33
99559	39.75	383	26508258859	20	104591	33.40	427	26508247433	33
99915	7.15	365	26508045541	2500	104592	33.40	427	26508247440	-
100110	16.20	365	26508055632	1	104593	33.40	427	26508247457	33
100224	23.45	372	26508092262	45	104594	33.40	427	26508247464	33
100224P	36.60	372	26508092279	0	104595	33.40	427	26508247471	-
100679	69.05	372	26508057704	12	104597	23.75	427	26508246849	40
100686	59.75	441	26508057711	60	104617	42.35	423	26508273999	-
100710	23.10	366	26508059524	18	104618	100.30	423	26508274002	-
100816	34.90	370	26508124178	50	104619	100.30	423	26508274019	-
100817	37.10	370	26508124185	100	104620	100.30	423	26508274026	-
100818	51.50	370	26508124192	20	104621	100.30	423	26508274033	-
101100	20.60	372	26508096550	100	104622	100.30	423	26508274040	-
101629	190.65	441	26508064375	9	104623	100.30	423	26508274057	-
101663BG	45.25	355	26508285411	12	104624	100.30	423	26508274064	-
101663BN	45.25	355	26508120897	12	104625	47.20	423	26508274071	-
101663ORB	44.85	355	26508100349	12	104626	48.50	423	26508274088	-
101663WR	46.10	355	26508120927	12	104627	45.10	423	26508274095	-
101664BG	47.00	355	26508285428	12	104628	95.10	423	26508274101	12
101664BN	48.80	355	26508120903	12	104630	119.55	418	26508273609	12
101664ORB	47.00	355	26508100363	12	104631	45.20	423	26508274118	-
101664WR	47.00	355	26508120934	12	104633	145.60	423	26508274125	12
104414	75.90	441	26508081525	0	104634	31.85	423	26508274132	-
104424	144.00	418	26508084229	12	105320	159.45	371	26508085165	0
104451	223.55	417	26508199282	12	106321	161.60	371	26508085158	6
104465	223.55	104	26508204368	12	106378	22.05	371	26508085868	250
104540	44.35	427	26508245293	20	106479	5.30	372	26508085899	300
104541	46.70	427	26508245309	20	114348	77.75	344	26508118085	12
104542	51.55	427	26508245316	20	114348ORB	125.40	344	26508101766	12
104543	56.45	427	26508245323	20	114348WR	125.40	344	26508118122	12
104544	61.25	427	26508245330	20	116651	20.05	347	26508128572	6
104545	66.15	427	26508245347	20	116651BN	32.95	347	26508128589	6
104546	41.60	427	26508245354	20	116651NL	32.95	347	26508147146	6
104547	46.40	427	26508245361	20	116651ORB	32.95	347	26508147191	6
104548	51.30	427	26508245378	20	116651WR	32.95	347	26508128596	6
104549	56.00	427	26508245385	20	116711	8.05	367	26508135686	500
104550	60.85	427	26508245392	20	118305	14.50	365	26508130148	100
104551	65.65	427	26508245408	20	121620	40.15	364	26508136683	24
104552	70.45	427	26508245415	20	123815	28.65	347	26508140437	12
104553	75.30	427	26508245422	20	123815BG	63.45	347	26508285138	12
104554	80.15	427	26508245439	20	123815BL	63.45	347	26508279410	12
104555	130.80	423	26508246535	20	123815BN	63.45	347	26508152881	12
104556	130.80	423	26508244074	20	123815ORB	63.45	347	26508164983	12
104557	24.75	427	26508244081	20	123816	67.60	369	26508140444	12
104560	54.65	427	26508247891	12	123816BN	112.50	369	26508166994	12
104561	77.45	427	26508246559	20	123816ORB	112.50	369	26508167007	12
104563	81.45	427	26508245446	20	128284	32.75	286	26508156568	12
104564	81.45	427	26508246573	20	129102	42.50	371	26508173114	12
104565	81.45	427	26508245453	20	129102BN	76.50	371	26508173121	12
104566	81.45	427	26508245460	20	129102NL	76.50	371	26508173176	12
104567	81.45	427	26508245477	20	129102ORB	76.50	371	26508173152	12
104568	81.45	427	26508245484	20	129102WR	76.50	371	26508173145	12
104569	31.30	427	26508245491	20	130153	40.85	371	26508158500	12
104570	22.05	423	26508245507	12	130153BN	69.80	371	26508158517	-
104571	29.45	423	26508246580	20	130153NL	69.80	371	26508157244	12
104572	8.00	427	26508245514	20	130153ORB	69.80	371	26508158524	12
104578	49.25	423	26508244098	12	130153WR	69.80	371	26508158531	12
104579	49.25	423	26508244104	12	131553	94.20	369	26508157862	12

Wholesale

Listed in numerical order

MODEL NUMBER	LIST PRICE	PAGE NO.	UNIVERSAL PRODUCT CODE	CASE QTY
131553BG	138.85	369	26508286616	-
131553BL	138.85	369	26508305096	-
131553BN	138.85	369	26508200742	12
131553NL	138.85	369	26508230916	12
131553ORB	138.85	369	26508200759	12
135167	57.85	371	26508171677	9
135167BN	163.15	371	26508171318	9
135167WR	163.15	371	26508171325	9
137114	97.45	370	26508173275	20
137347	51.95	370	26508173565	9
137347BN	100.45	370	26508173589	9
137347P	100.45	370	26508173602	9
137347WR	100.45	370	26508173619	9
137401	15.70	368	26508180310	12
140676	6.45	365	26508184356	96
140680	17.65	354	26508184431	12
140715	11.35	104	26508187517	200
140780	94.40	147	26508165720	12
140780BG	136.05	160	26508286623	-
140780BL	136.05	160	26508299371	12
140780BN	136.05	147	26508165737	12
140780ORB	136.05	147	26508165744	12
141002	55.35	28	26508187296	6
141002BG	61.65	34	26508283677	6
141002BL	61.65	29	26508229019	6
141002ORB	61.65	46	26508211410	-
141002SRS	61.65	28	26508209370	6
142538	6.20	354	26508188668	180
143326	15.25	368	26508199695	100
143530	10.85	369	26508193167	144
145058	21.85	372	26508190432	50
145665	6.75	370	26508193044	-
147204	41.90	89	26508204450	12
147204BN	59.15	89	26508205136	12
147206	91.30	371	26508200544	12
147208	274.65	364	26508200568	12
147212	31.10	371	26508200605	12
147913	148.30	342	26508200513	6
147913BN	253.25	342	26508200520	6
148479	34.15	371	26508202975	25
148479BN	64.80	371	26508202982	25
148479WR	64.80	371	26508202999	25
150257	48.30	364	26508205693	50
150313	10.80	365	26508205563	12
150627	33.55	366	26508213834	50
151380	76.40	346	26508207413	6
151380BN	131.00	346	26508207420	6
151380ORB	131.00	346	26508207437	6
152027	72.05	351	26508207550	12
152027BN	114.55	351	26508207567	12
154289	9.80	367	26508218075	20
154305	171.80	342	26508218488	6
154305BN	251.50	342	26508218495	6
154305NL	251.50	342	26508231098	6
154305ORB	251.50	342	26508218501	6
154364	8.10	367	26508213612	100
155656	41.95	370	26508219867	-
155694	29.85	344	26508221372	12
155694BN	45.25	344	26508221389	12
155694ORB	45.25	344	26508227565	12
155746	218.90	348	26508221396	6
155746BN	320.50	348	26508221402	-
155746ORB	320.50	348	26508227572	6
155747	97.20	342	26508221419	-
155747BN	152.35	342	26508221426	-
155747ORB	146.80	342	26508227589	6
155748	78.20	348	26508221433	-

MODEL NUMBER	LIST PRICE	PAGE NO.	UNIVERSAL PRODUCT CODE	CASE QTY
155748BN	164.80	348	26508221440	-
155891	88.60	342	26508223178	6
155891BL	130.10	342	265082278185	6
155891BN	133.85	342	26508223185	6
157328	60.00	33	26508239056	6
157328ORB	85.15	33	26508255179	6
157328SRS	85.15	33	26508225103	6
159060	23.60	368	26508231425	6
160042	163.15	343	26508228166	6
160042BN	265.20	343	26508228173	6
160042ORB	265.20	343	26508228180	6
161951	104.85	346	26508233559	12
161951BG	138.10	346	26508285237	12
161951BL	138.10	346	26508299432	12
161951BN	138.10	346	26508233610	12
161951NL	138.10	346	26508299449	12
161951ORB	138.10	346	26508233627	12
161955	101.65	350	26508233726	6
161955BG	145.45	350	26508285589	6
161955BN	145.45	350	26508233733	6
161955NL	145.45	350	26508299456	6
161955ORB	145.45	350	26508233740	6
163847	8.10	368	26508238264	100
164745	14.00	347	26508239247	20
164745BG	31.60	347	26508285244	20
164745BN	31.60	347	26508239254	20
164745ORB	31.60	347	26508239261	20
164927	110.75	341	26508241585	6
164927BN	176.10	341	26508241592	6
164927ORB	176.10	341	26508241608	-
164928	108.70	343	26508241615	6
164928BL	172.80	343	26508290194	6
164928BN	172.80	343	26508241622	6
164928ORB	172.80	343	26508241639	-
164929	97.20	341	26508241646	6
164929BN	152.35	341	26508241653	6
164929ORB	152.35	341	26508241660	6
165006	31.25	219	26508239926	20
165006BL	51.20	219	26508306482	1
165006BN	51.20	219	26508260067	20
165018	8.10	368	26508240120	12
168665	35.85	369	26508239193	50
168666	23.05	369	26508244487	50
169031	172.20	28	26508266199	12
172656	100.45	351	26508251003	6
172656BG	129.15	351	26508285145	6
172656BL	129.15	351	26508274675	6
172656BN	132.85	351	26508251010	6
172666	26.15	160	26508250938	20
172666BG	38.60	160	26508292006	20
172666BN	38.60	160	26508250945	20
174055	38.00	418	26508235799	12
174056	109.80	418	26508235904	12
174057	36.20	418	26508235911	12
174060	22.65	418	26508235942	12
174061	37.35	418	26508235959	12
174062	22.05	418	26508252765	12
174065	59.45	418	26508252772	12
174066	10.80	418	26508252789	12
174335	248.05	418	26508254394	12
174336	25.20	418	26508254400	20
174337	25.20	418	26508254417	20
175083	8.10	367	26508252895	200
175084	8.10	367	26508252901	350
175385	103.25	351	26508257753	6
175385BN	148.75	351	26508257760	6
175385NL	148.75	351	26508257777	6

MODEL NUMBER	LIST PRICE	PAGE NO.	UNIVERSAL PRODUCT CODE	CASE QTY	MODEL NUMBER	LIST PRICE	PAGE NO.	UNIVERSAL PRODUCT CODE	CASE QTY
175385ORB	148.75	351	26508257784	6	226651ORB	93.30	346	26508165805	6
176015	142.05	343	26508253335	12	226651WR	93.30	346	26508165829	6
176015BN	245.55	343	26508253359	12	316711	8.10	367	26508178775	350
176015ORB	245.55	343	26508253373	12	416711	8.10	367	26508178782	200
176015P	245.55	343	26508256695	12	516711	8.10	367	26508180464	500
176015WR	245.55	343	26508254028	12	A501	114.70	345	26508149119	12
176257	105.80	343	26508254974	-	A501BN	154.60	345	26508149300	12
176257BN	160.30	343	26508254981	6	A501NL	154.60	345	26508149171	12
179573	104.70	280	26508274224	6	A501ORB	154.60	345	26508149256	12
181148	109.45	412	26508274491	12	A501P	154.60	345	26508149140	12
181149	101.75	412	26508274507	12	A501WR	154.60	345	26508149188	12
182413	87.05	418	26508272305	-	A701	54.80	344	26508232941	12
182414	24.60	418	26508272312	12	A701BN	88.25	344	26508232958	12
182415	179.50	418	26508272329	-	A701ORB	88.25	344	26508232965	12
182416	133.25	418	26508272336	12	A705CBN	92.60	438	26508240823	12
182417	73.25	418	26508272343	-	A714	88.10	348	26508042847	24
182418	45.80	418	26508272350	-	A714ST	106.25	348	26508081013	24
182419	22.25	418	26508272367	-	A720	78.70	344	26508042892	12
182420	58.30	418	26508272374	-	A720BN	104.20	344	26508141984	12
182421	84.60	418	26508272381	-	A720ORB	104.20	344	26508141991	12
182422	208.20	418	26508272398	-	A720P	104.20	344	26508079447	12
182423	18.00	418	26508272404	12	A721	71.15	344	26508227725	12
182534	75.30	418	26508273708	-	A721BG	101.65	344	26508282496	12
182535	214.25	418	26508273715	6	A721BN	101.65	344	26508227732	12
182536	12.75	418	26508273722	20	A721ORB	101.65	344	26508282472	12
182537	223.25	418	26508273739	12	A725	63.00	344	26508044551	12
182538	29.95	418	26508273746	20	A725BG	90.20	344	26508285275	12
182539	59.20	418	26508273753	12	A725BN	90.20	344	26508121955	12
182540	68.00	418	26508273760	12	A725CBN	89.85	441	26508191224	12
182542	23.25	418	26508273777	20	A725NL	90.20	344	26508079232	12
182543	23.10	418	26508273784	20	A725ORB	90.20	344	26508132166	12
182544	23.10	418	26508273791	20	A725P	90.20	344	26508044575	12
182546	43.65	412	26508273807	12	A725WR	90.20	344	26508121962	12
182547	35.45	418	26508273814	20	A726	92.40	348	26508073032	12
189315	100.70	342	26508282120	6	A726BG	202.25	348	26508285367	12
189315BL	153.55	342	26508285459	6	A726BR	202.25	348	26508181225	12
189315BN	153.55	342	26508282137	6	A726NL	202.25	348	26508079638	24
189315ORB	153.55	342	26508282144	6	A726P	202.25	348	26508073049	24
189318	89.95	342	26508282151	6	A726ST	202.25	348	26508079645	12
189318BN	130.55	342	26508282168	6	A726WR	202.25	348	26508118412	6
189318ORB	130.55	342	26508282182	6	A735	268.00	348	26508172728	6
191956	95.10	353	26508281178	6	A735BN	402.55	348	26508172735	6
191956BN	136.80	353	26508281185	6	A735ORB	402.55	348	26508172742	6
191956ORB	136.80	353	26508281192	6	A735P	402.55	348	26508172803	6
193148	40.35	189	26508295540	12	A735WR	402.55	348	26508172766	6
195386	93.90	353	26508281208	6	A750	48.65	337	34584010643	24
195386BN	135.90	353	26508281215	6	A780	133.40	348	26508227138	20
195386NL	135.90	353	26508281222	6	A1616	138.45	123	26508125786	6
195386ORB	135.90	353	26508281239	6	A1616BN	224.65	123	26508125793	6
216711	8.10	367	26508178768	200	A1616ORB	224.65	123	26508132142	6
216721	8.10	367	26508186374	700	A1616WR	224.65	207	26508125809	6
221672	27.25	56	26508224519	12	A1717	138.45	121	26508166116	6
221672BL	40.20	56	26508301166	-	A1717BN	224.65	121	26508166123	6
221672BN	40.20	56	26508224526	12	A1717ORB	224.65	238	26508199015	6
221672NL	40.20	56	26508231135	12	A2020	138.45	262	26508206973	6
221672ORB	40.20	56	26508224533	-	A2020BN	224.65	262	26508206980	6
221673	18.65	62	26508224540	12	AT2099	36.70	347	26508065112	12
221673BL	27.50	62	26508301173	-	AT2099BN	51.25	347	26508105924	12
221673BN	27.50	62	26508224557	-	AT2099ORB	51.25	347	26508132173	12
221673NL	27.50	62	26508231142	12	AT2099P	51.25	347	26508065129	12
221673ORB	27.50	62	26508224564	-	AT2199	11.50	347	26508065136	200
221772	46.15	58	26508256947	12	AT2199BN	30.55	347	26508130162	200
221772BN	55.20	58	26508256954	12	AT2199NL	30.55	347	26508104057	48
226651	51.40	346	26508165751	6	AT2199ORB	30.55	347	26508132180	200
226651BG	93.30	346	26508285596	6	AT2199P	30.55	347	26508065143	48
226651BN	93.30	346	26508165782	6	AT2199SLP	18.55	347	26508123386	24
226651NL	93.30	346	26508165799	6	AT2199WR	30.55	347	26508118436	12

Wholesale

Listed in numerical order

MODEL NUMBER	LIST PRICE	PAGE NO.	UNIVERSAL PRODUCT CODE	CASE QTY
BH3803CH	37.25	261	34584024848	12
BH3808CH	91.25	261	34584024855	3
BH3818CH	103.70	261	34584024862	3
BH3824CH	115.10	261	34584024879	3
BH3886CH	79.40	261	34584024886	3
BP3703CH	44.05	193	34584025418	24
BP3708CH	65.35	193	34584025432	6
BP3718CH	98.90	193	34584025456	6
BP3724CH	100.65	193	34584025470	6
BP3786CH	67.00	193	34584025494	6
CA8301	845.85	412	26508211076	6
CA8302	840.05	412	26508211083	6
CA8303	891.40	413	26508211090	6
CL703	97.65	344	26508250549	12
CL703BN	149.50	344	26508250556	12
CL703ORB	149.50	344	26508250563	12
CL707	132.40	344	26508250570	12
CL707BN	202.70	344	26508250587	12
CL707ORB	202.70	344	26508250594	12
CSR2145BN	50.55	358	34584023391	10
CSR2145CH	44.30	358	34584023407	10
CSR2155BN	52.55	358	34584023414	10
CSR2155CH	47.20	358	34584023421	10
CSR2155OWB	59.05	358	34584023438	10
CSR2160BG	67.10	358	34584028587	10
CSR2160BN	67.10	358	34584008848	10
CSR2160CH	61.05	358	34584008831	10
CSR2160OWB	76.65	358	34584008855	10
CSR2165BN	52.85	358	34584008800	10
CSR2165CH	48.05	358	34584008794	10
CSR2165OWB	60.85	358	34584011336	10
CSR2166BN	60.75	358	34584008824	10
CSR2166CH	55.30	358	34584008817	10
DN2141BN	85.35	358	34584017543	2
DN2141CH	82.45	358	34584017536	2
DN2141OWB	99.40	358	34584017550	2
DN2160BN	74.15	358	34584011343	3
DN2160CH	67.45	358	34584011350	3
DN2160OWB	84.85	358	34584011367	3
DN7025	75.70	361	34584179661	2
DN7065	173.40	361	34584484284	1
DN7110	480.65	361	34584019141	2
L2353	239.45	273	26508047569	6
L4621	194.05	269	26508047286	12
L4621BC	229.90	269	26508136706	12
L4621P	377.20	269	26508047385	12
L4625	194.05	269	26508047323	6
LR2350DBN	61.65	360	34584017598	3
LR2350DCH	61.65	360	34584020857	3
LR2350DOWB	73.75	360	34584020864	3
LR2352DBN	61.65	360	34584017604	3
LR2352DCH	61.65	360	34584020871	3
LR2352DOWB	73.75	360	34584020888	3
LR2354DBN	61.65	360	34584020550	3
LR2354DCH	61.65	360	34584020918	3
LR2354DOWB	73.75	360	34584020925	3
LR2356DBN	61.65	360	34584017611	3
LR2356DCH	61.65	360	34584020895	3
LR2356DOWB	73.75	360	34584020901	3
M1460BL	16.50	374	26508134023	50
M1510BL	20.95	374	26508134290	50
M1720BL	55.85	374	26508150818	6
M1725BL	69.80	374	26508150825	6
M1921	71.85	374	26508922453	20
M1923	112.55	374	26508150610	20
M1941	23.85	374	26508921043	72
M2060	22.55	375	26508921302	10

MODEL NUMBER	LIST PRICE	PAGE NO.	UNIVERSAL PRODUCT CODE	CASE QTY
M2070	28.10	375	26508134634	24
M2072	35.10	375	26508134658	24
M2073	28.10	375	26508206027	24
M2074	28.10	375	26508206034	24
M2075	35.10	375	26508206041	24
M9955BL	39.75	374	26508922552	36
M9957BL	60.35	374	26508122877	36
S0001	74.35	399	26508025314	12
S0002	98.25	399	26508025321	12
S0003	77.70	399	26508025338	12
S0004	92.95	399	26508025345	12
S0007	76.35	399	26508025376	12
S0009	84.95	399	26508025390	12
S0010	81.20	399	26508025406	12
S0011	87.30	399	26508025413	12
S0012	165.90	399	26508025420	12
S0020	75.25	399	26508148112	12
S0030	83.40	399	26508148129	12
S0030NA	83.40	399	26508273821	6
S0050	93.85	399	26508160718	12
S0070	96.55	399	26508181478	12
S110	125.85	346	26508242353	6
S110BL	155.25	346	26508279434	6
S110BN	155.25	346	26508242360	6
S112	404.20	330	26508132753	3
S112BN	537.30	330	26508132760	3
S112EP	404.20	330	26508221761	3
S112EPBN	537.30	330	26508222065	3
S112EPNL	537.30	330	26508222072	3
S112EPORB	537.30	330	26508222089	3
S112EPWR	537.30	330	26508222096	-
S112NL	537.30	330	26508144671	3
S112ORB	537.30	330	26508144664	3
S112WR	537.30	330	26508132777	3
S113	125.85	346	26508133965	6
S113BG	155.25	346	26508285978	3
S113BN	155.25	346	26508133972	6
S113NL	155.25	346	26508144695	3
S113ORB	155.25	346	26508144688	6
S113WR	155.25	346	26508133989	3
S114	136.60	349	26508185261	6
S114BN	223.55	349	26508185278	6
S114ORB	223.55	349	26508185292	6
S115	141.10	81	26508186190	6
S115BN	228.90	81	26508186206	6
S115ORB	228.90	81	26508186220	6
S122	50.85	346	26508223499	6
S122BN	96.75	346	26508223512	6
S122ORB	96.75	346	26508223529	6
S176	212.95	331	26508139189	3
S176BG	317.20	331	26508285190	3
S176BL	317.20	331	26508279335	3
S176BN	317.20	331	26508152911	3
S176EP	212.95	331	26508214558	3
S176EPBG	317.20	331	26508286012	3
S176EPBL	317.20	331	26508279342	3
S176EPBN	317.20	331	26508214565	3
S411	485.15	81	26508132524	3
S411BN	741.20	81	26508132739	3
S411ORB	741.20	81	26508144541	3
S664	837.80	43	26508200063	3
S664BG	1,171.25	43	26508283967	3
S664BL	1,171.25	43	26508289525	3
S664NL	1,171.25	43	26508294352	-
S664ORB	1,171.25	43	26508169032	3
S664SRS	1,171.25	43	26508234242	3
S665	837.80	43	26508205617	3

MODEL NUMBER	LIST PRICE	PAGE NO.	UNIVERSAL PRODUCT CODE	CASE QTY	MODEL NUMBER	LIST PRICE	PAGE NO.	UNIVERSAL PRODUCT CODE	CASE QTY
S665BG	1,171.25	43	26508283974	3	S3879EPBN	808.40	338	26508221891	6
S665BL	1,171.25	43	26508289532	3	S3880EP	420.45	338	26508282380	6
S665SRS	1,171.25	43	26508234259	3	S3880EPBN	808.40	338	26508282373	6
S711	681.60	30	26508098943	2	S3896	117.50	349	26508220764	6
S711ORB	869.75	30	26508144442	2	S3896BN	185.20	349	26508222126	6
S711SRS	869.75	30	26508242056	3	S3898	109.50	353	26508220450	6
S712	793.00	30	26508132678	2	S3898BN	177.65	353	26508220467	6
S712ORB	1,064.10	30	26508144428	2	S3900	120.70	349	26508263990	6
S712SRS	1,064.10	30	26508242063	2	S3901	114.05	353	26508281284	6
S713	1,123.00	30	26508132784	3	S3945BG	201.95	51	26508283882	6
S713ORB	1,500.75	30	26508144404	3	S3945BL	201.95	51	26508289945	6
S713SRS	1,500.75	30	26508242070	3	S3945C	160.00	51	26508248911	-
S713WR	1,500.75	30	26508132807	3	S3945NL	201.95	51	26508295236	-
S905	2,070.60	91	26508298480	1	S3945ORB	201.95	51	26508248928	6
S905BN	2,950.50	91	26508298497	1	S3945SRS	201.95	51	26508248935	6
S1001	448.50	329	26508282366	3	S3946BG	201.95	51	26508283899	6
S1001EP	448.50	329	26508290507	3	S3946BL	201.95	51	26508247167	6
S1002	476.20	329	26508290514	3	S3946C	160.00	51	26508248942	6
S1002EP	476.20	329	26508290521	3	S3946ORB	201.95	51	26508248959	6
S1003	470.65	329	26508290538	3	S3946SRS	201.95	51	26508248966	6
S1003EP	470.65	329	26508290545	3	S3947BG	201.95	51	26508283905	6
S1004	498.35	329	26508290552	3	S3947BL	201.95	51	26508289457	6
S1004EP	498.35	329	26508290569	3	S3947C	160.00	51	26508248973	6
S1005	420.85	329	26508290576	3	S3947SRS	201.95	51	26508247327	6
S1005EP	420.85	329	26508290583	3	S3948BL	201.95	51	26508289464	6
S1006	443.00	329	26508290590	3	S3948C	160.00	51	26508247150	6
S1006EP	443.00	329	26508290606	3	S3948ORB	201.95	51	26508250273	6
S1300	106.00	345	26508219621	6	S3948SRS	201.95	51	26508250280	6
S1311	434.65	329	26508152171	3	S5170	455.65	44	26508222102	3
S1311BG	595.10	329	26508285282	3	S5170SRS	590.60	44	26508241974	3
S1311BL	595.10	329	26508301326	-	S5500	269.70	50	26508249475	6
S1311BN	595.10	329	26508152188	3	S5510	303.40	49	26508249482	3
S1311EP	434.65	330	26508213988	3	S5510BG	457.95	49	26508283912	3
S1311EPBG	595.10	330	26508285299	3	S5510BL	457.95	49	26508289471	3
S1311EPBL	595.10	330	26508301333	-	S5510NL	457.95	49	26508294345	-
S1311EPBN	595.10	330	26508214015	3	S5510ORB	457.95	49	26508249499	3
S1311EPNL	595.10	330	26508231180	3	S5510SRS	457.95	49	26508249505	3
S1311EPORB	595.10	330	26508214022	3	S5520	303.40	49	26508249512	3
S1311NL	595.10	329	26508231197	3	S5520BG	457.95	49	26508283929	3
S1311ORB	595.10	329	26508152195	3	S5520BL	457.95	49	26508289488	3
S3102	922.15	281	26508269916	3	S5520ORB	457.95	49	26508249529	3
S3104	1,917.00	281	26508269923	3	S5520SRS	457.95	49	26508249536	3
S3105	2,070.60	112	26508294277	1	S5530	303.40	49	26508249543	3
S3105BL	2,950.50	112	26508294284	1	S5530BG	457.95	49	26508283936	3
S3105BN	2,950.50	112	26508294291	1	S5530BL	457.95	49	26508289495	3
S3371	626.05	105	26508216408	6	S5530SRS	457.95	49	26508249550	3
S3600	141.15	105	26508216439	12	S6202	422.25	123	26508216507	3
S3835	131.75	349	26508291221	6	S6202BN	674.60	123	26508216521	3
S3835BL	214.50	349	26508291238	6	S6202ORB	674.60	123	26508216538	3
S3835BN	214.50	349	26508291245	6	S6310	211.90	331	26508220771	3
S3836	120.70	353	26508291252	6	S6310BN	315.65	331	26508220986	3
S3836BL	203.40	353	26508291269	6	S6310EP	211.90	331	26508221921	3
S3836BN	203.40	353	26508291276	6	S6310EPBN	315.65	331	26508221938	3
S3840	99.40	349	26508220726	6	S6310EPORB	315.65	331	26508221945	3
S3840BN	143.10	349	26508220894	6	S6310ORB	315.65	331	26508220993	3
S3842	91.70	353	26508220733	6	S6312	143.80	332	26508220788	12
S3842BN	126.85	353	26508220917	6	S6312BN	185.05	332	26508221037	12
S3859	116.55	349	26508220740	6	S6312EP	143.80	332	26508222003	12
S3859BN	182.15	349	26508220931	6	S6312EPBN	185.05	332	26508222027	12
S3859ORB	182.15	349	26508220948	6	S6320	288.70	330	26508220795	3
S3860	112.75	353	26508220412	6	S6320BG	486.80	330	26508286494	3
S3860BN	174.75	353	26508220436	6	S6320BN	486.80	330	26508221068	3
S3860ORB	174.75	353	26508220443	6	S6320EP	288.70	330	26508221853	3
S3870EP	381.85	338	26508228975	6	S6320EPBG	486.80	330	26508285206	3
S3870EPBN	831.80	338	26508228982	6	S6320EPBN	486.80	330	26508221860	3
S3870EPORB	831.80	338	26508228999	6	S6320EPORB	486.80	330	26508221877	3
S3879EP	420.45	338	26508221884	6	S6320ORB	486.80	330	26508221075	3

Wholesale

Listed in numerical order

MODEL NUMBER	LIST PRICE	PAGE NO.	UNIVERSAL PRODUCT CODE	CASE QTY
S6335	151.15	332	26508220849	6
S6335BN	243.45	332	26508220863	6
S6335EP	151.15	332	26508221778	6
S6335EPBN	243.45	332	26508222041	6
S6335EPORB	243.45	332	26508222058	6
S6335ORB	243.45	332	26508220870	6
S6340	151.15	332	26508220801	3
S6340BN	243.45	332	26508220634	3
S6340EP	151.15	332	26508221907	3
S6340EPBN	243.45	332	26508221914	3
S6345	303.20	331	26508260944	3
S6345BG	511.15	331	26508286036	3
S6345BN	511.15	331	26508260951	3
S6345EP	303.20	331	26508260968	3
S6345EPBG	511.15	331	26508286043	3
S6345EPBN	511.15	331	26508260975	3
S6360	257.65	330	26508220481	3
S6360BN	420.95	330	26508220498	3
S6360EP	257.65	330	26508220504	3
S6360EPBN	420.95	330	26508220511	3
S6360EPORB	420.95	330	26508224946	3
S6360ORB	420.95	330	26508224953	3
S6365	151.15	332	26508230220	3
S6365BG	243.45	332	26508285305	3
S6365BL	243.45	332	26508289501	-
S6365BN	243.45	332	26508230237	3
S6365EP	151.15	332	26508230244	3
S6365EPBG	243.45	332	26508285312	3
S6365EPBL	243.45	332	26508289518	-
S6365EPBN	243.45	332	26508230251	3
S6365EPNL	243.45	332	26508301371	-
S6365EPORB	243.45	332	26508230268	3
S6365NL	243.45	332	26508301388	-
S6365ORB	243.45	332	26508230275	3
S6500	357.05	121	26508216545	3
S6500BN	584.20	121	26508216569	3
S6510	343.15	121	26508216576	3
S6510BN	542.05	121	26508216590	3
S6700	422.25	89	26508216606	3
S6700BN	674.60	89	26508216613	3
S6705	485.50	89	26508242377	3
S6705BN	775.80	89	26508242384	3
S6711	561.55	89	26508216620	3
S6711BN	843.30	89	26508216637	3
S6910	422.00	111	26508291085	3
S6910BL	674.60	111	26508291092	3
S6910BN	674.60	111	26508291108	3
S7170	506.65	31	26508216644	3
S7597C	778.05	31	26508216668	3
S7597SRS	985.70	31	26508242124	3
S8000	422.25	103	26508261446	3
S8000BLC	775.80	103	26508305799	3
S11705EP	359.50	341	26508221969	6
S11705EPBN	658.00	341	26508221952	6
S12104	143.80	349	26508215531	6
S12104BG	235.30	349	26508285985	6
S12104BL	235.30	349	26508301302	-
S12104BN	235.30	349	26508215548	6
S12104ORB	235.30	349	26508215555	6
S12105	136.05	353	26508281246	6
S12105BL	226.35	353	26508301319	-
S12105BN	226.35	353	26508281253	6
S12105NL	226.35	353	26508281260	6
S12105ORB	226.35	353	26508281277	6
S12107EP	420.45	337	26508218945	6
S12107EPBG	808.40	337	26508286005	6
S12107EPBN	808.40	337	26508218952	6

MODEL NUMBER	LIST PRICE	PAGE NO.	UNIVERSAL PRODUCT CODE	CASE QTY
S12107EPNL	808.40	337	26508231173	6
S12107EPORB	808.40	337	26508218969	6
S16900	132.30	353	26508282946	6
S16900BL	220.50	353	26508301340	-
S16900BN	220.50	353	26508282953	6
S22105	2,026.30	58	26508251072	1
S22105BN	2,962.30	58	26508251089	1
S22105ORB	2,962.30	58	26508285015	1
S22110	2,026.30	58	26508255001	0
S22110BN	2,962.30	58	26508255018	0
S22110ORB	2,962.30	58	26508285022	1
S42107	544.50	56	26508215562	3
S42107BG	830.35	56	26508286029	3
S42107BL	830.35	56	26508301357	-
S42107BN	830.35	56	26508215579	3
S42107NL	830.35	56	26508231203	3
S42107ORB	830.35	56	26508215586	3
S43001	514.55	69	26508242391	3
S43001BL	785.25	69	26508301364	-
S43001BN	785.25	69	26508242407	3
S52003	556.25	45	26508294734	3
S52003BL	720.40	45	26508294741	3
S52003SRS	720.40	45	26508294758	3
S53004	579.85	44	26508288689	3
S53004BG	771.10	44	26508299241	3
S53004NL	771.10	44	26508288696	3
S53004ORB	771.10	44	26508288702	3
S53004SRS	771.10	44	26508288719	3
S55005	678.80	45	26508288764	3
S55005BL	868.90	45	26508288771	3
S55005SRS	868.90	45	26508288788	3
S62101	509.05	44	26508236420	3
S62101BG	778.30	44	26508283943	3
S62101NL	778.30	44	26508236437	3
S62101ORB	778.30	44	26508236444	3
S62101SRS	778.30	44	26508236451	3
S62308	616.35	45	26508236796	3
S62308BG	797.95	45	26508283950	3
S62308BL	759.40	45	26508236802	3
S62308BLC	917.65	45	26508305775	3
S62308SRS	797.95	45	26508236819	3
S62608	575.60	45	26508248478	3
S62608SRS	769.10	45	26508248485	3
S72003	632.40	32	26508294765	3
S72003BL	839.05	32	26508294772	3
S72003SRS	839.05	32	26508294789	3
S72101	885.05	31	26508236468	3
S72101BG	1,183.30	31	26508283981	3
S72101NL	1,183.30	31	26508236475	3
S72101ORB	1,183.30	31	26508236482	3
S72101SRS	1,183.30	31	26508236499	3
S72308	691.60	32	26508236826	3
S72308BG	909.10	32	26508283998	3
S72308BL	843.75	32	26508236833	3
S72308BLC	1,045.45	32	26508305782	3
S72308EC	1,080.80	28	26508257968	3
S72308ESRS	1,221.75	28	26508257975	3
S72308SRS	909.10	32	26508236840	3
S72608	660.45	32	26508248492	3
S72608SRS	875.20	32	26508248508	3
S73004	651.55	31	26508288726	3
S73004BG	866.45	31	26508299234	3
S73004NL	866.45	31	26508288733	3
S73004ORB	866.45	31	26508288740	3
S73004SRS	866.45	31	26508288757	3
S75005	762.70	31	26508288795	3
S75005BL	976.25	31	26508288801	3

MODEL NUMBER	LIST PRICE	PAGE NO.	UNIVERSAL PRODUCT CODE	CASE QTY	MODEL NUMBER	LIST PRICE	PAGE NO.	UNIVERSAL PRODUCT CODE	CASE QTY
S75005SRS	976.25	31	26508288818	3	T943	312.80	249	26508153192	3
S93005	2,070.60	70	26508251096	1	T943BN	515.65	249	26508153208	3
S93005BN	2,950.50	70	26508251102	0	T943ORB	515.65	249	26508153215	3
SMA1000CH	48.80	360	34584007728	24	T944	516.85	250	26508153161	3
SMA1000WB	48.80	101	34584007735	24	T944BN	769.30	250	26508153178	3
SMA1001CH	43.55	360	34584007759	10	T944ORB	769.30	250	26508153185	3
SMA1005CH	21.20	101	34584017628	3	T967	338.05	257	26508273135	3
SV003	161.75	399	26508025444	12	T986	312.80	263	26508207178	3
SV006	148.35	399	26508025475	12	T986BN	515.65	263	26508207185	3
SV010	172.40	399	26508025512	12	T987	516.85	264	26508207192	3
T373	344.05	233	26508261316	3	T987BN	769.30	264	26508207208	3
T373BN	567.15	233	26508261323	3	T990	296.05	271	26508125724	6
T393	412.80	162	26508249642	3	T990BC	368.35	271	26508136751	6
T393BG	661.80	162	26508285909	3	T991	379.10	272	26508125731	6
T393BL	661.80	162	26508281925	3	T994	153.85	270	26508017173	6
T393BN	661.80	162	26508249659	3	T999	251.60	271	26508015858	6
T394	622.55	163	26508249666	3	T2011	122.55	253	26508281420	12
T394BG	947.80	163	26508285893	3	T2011BN	185.65	253	26508281437	12
T394BN	947.80	163	26508249673	3	T2011ORB	185.65	253	26508281444	12
T653	413.60	150	26508253830	3	T2021	122.55	242	26508281451	12
T653BN	644.10	150	26508253847	3	T2021BN	185.65	242	26508281468	12
T653NL	644.10	150	26508256091	3	T2021ORB	185.65	242	26508281475	12
T653ORB	644.10	150	26508256107	3	T2081	125.25	222	26508281543	12
T654	657.90	151	26508256114	3	T2081BL	189.70	222	26508301395	-
T654BN	1,078.50	151	26508254448	3	T2081BN	189.70	222	26508281604	12
T654NL	1,078.50	151	26508254509	3	T2082	130.55	222	26508281611	12
T654ORB	1,078.50	151	26508254578	3	T2082BL	197.75	222	26508301401	-
T657	413.60	150	26508253854	3	T2082BN	197.75	222	26508281628	12
T657BN	644.10	150	26508253861	3	T2111	142.25	216	26508107980	3
T657NL	644.10	150	26508256121	3	T2111BN	268.75	216	26508115305	3
T657ORB	644.10	150	26508256138	3	T2111ORB	268.75	216	26508132364	3
T658	657.90	151	26508256145	3	T2111WR	268.75	216	26508115381	3
T658BN	1,078.50	151	26508256152	3	T2112	208.20	215	26508107997	3
T658ORB	1,078.50	151	26508256176	3	T2112BN	359.50	215	26508115312	3
T683	344.05	227	26508264621	3	T2112EP	208.20	215	26508208823	3
T683BN	567.15	227	26508264638	3	T2112EPBN	359.50	215	26508208854	3
T683ORB	567.15	227	26508264645	3	T2112EPORB	359.50	215	26508208861	3
T693	413.60	177	26508230701	3	T2112ORB	359.50	215	26508132371	3
T693BG	644.10	177	26508286272	3	T2112WR	359.50	215	26508115398	3
T693BN	644.10	177	26508230718	3	T2113	266.35	214	26508108000	3
T693NL	644.10	177	26508301777	-	T2113BN	441.70	214	26508115329	3
T693ORB	644.10	177	26508230725	3	T2113EP	266.35	214	26508208946	3
T694	657.90	178	26508230732	3	T2113EPBN	441.70	214	26508208977	3
T694BG	1,078.50	178	26508286487	3	T2113EPORB	441.70	214	26508208984	3
T694BN	1,078.50	178	26508230749	3	T2113ORB	441.70	214	26508132388	3
T694NL	1,078.50	178	26508301784	-	T2113WR	441.70	214	26508115404	3
T694ORB	1,078.50	178	26508230756	3	T2131	73.65	254	26508153222	3
T907	485.30	189	26508288474	3	T2131BN	178.35	254	26508153239	3
T920	509.65	209	26508126868	3	T2131ORB	178.35	254	26508153246	3
T920BN	755.85	209	26508126882	3	T2132	93.80	252	26508153253	3
T920ORB	755.85	209	26508132494	3	T2132BN	219.10	252	26508153260	3
T920WR	755.85	209	26508126899	3	T2132EPBN	219.10	252	26508209066	3
T922	788.00	210	26508126905	3	T2132EPORB	219.10	252	26508209073	3
T922BN	1,183.35	210	26508126929	3	T2132ORB	219.10	252	26508153277	3
T922ORB	1,183.35	210	26508132500	3	T2133	135.30	251	26508153284	3
T924	516.85	241	26508162019	3	T2133BN	288.15	251	26508153291	3
T924BN	769.30	241	26508161036	3	T2133EPBN	288.15	251	26508207833	3
T924ORB	769.30	241	26508161043	3	T2133EPORB	288.15	251	26508207840	3
T933	312.80	240	26508162118	3	T2133ORB	288.15	251	26508153307	3
T933BN	515.65	240	26508162132	3	T2151	73.65	245	26508162149	3
T933ORB	515.65	240	26508162125	3	T2151BN	178.35	245	26508162163	3
T935	312.80	220	26508027806	3	T2151ORB	178.35	245	26508162156	3
T935BL	515.65	220	26508301814	-	T2152	93.80	244	26508162170	3
T935BN	515.65	220	26508258385	3	T2152BN	219.10	244	26508162194	3
T936	516.85	221	26508235171	3	T2152EPBN	219.10	244	26508207871	3
T936BN	769.30	221	26508258392	3	T2152EPORB	219.10	244	26508207888	3
T937	419.05	221	26508027837	3	T2152ORB	219.10	244	26508162187	3

Wholesale

Listed in numerical order

MODEL NUMBER	LIST PRICE	PAGE NO.	UNIVERSAL PRODUCT CODE	CASE QTY
T2153	135.30	243	26508162200	3
T2153BN	288.15	243	26508162224	3
T2153EPBN	288.15	243	26508207918	3
T2153EPORB	288.15	243	26508207925	3
T2153ORB	288.15	243	26508162217	3
T2181	80.95	230	26508264423	3
T2181BN	196.15	230	26508264430	3
T2181ORB	196.15	230	26508264447	3
T2182	103.15	229	26508264454	3
T2182BN	241.00	229	26508264461	3
T2182EP	103.15	229	26508264478	3
T2182EPBN	241.00	229	26508264485	3
T2182EPORB	241.00	229	26508264492	3
T2182ORB	241.00	229	26508264508	3
T2183	148.90	228	26508264515	3
T2183BN	317.00	228	26508264522	3
T2183EP	148.90	228	26508264539	3
T2183EPBN	317.00	228	26508264546	3
T2183EPORB	317.00	228	26508264553	3
T2183ORB	317.00	228	26508264560	3
T2191	96.80	171	26508249680	3
T2191BG	237.25	171	26508286050	3
T2191BL	237.25	171	26508275030	3
T2191BN	237.25	171	26508249178	3
T2192	163.40	169	26508249710	3
T2192BG	319.95	169	26508286067	3
T2192BL	319.95	169	26508281888	3
T2192BN	319.95	169	26508249727	3
T2192EP	163.40	169	26508249185	3
T2192EPBG	319.95	169	26508286074	3
T2192EPBL	319.95	169	26508281895	3
T2192EPBN	319.95	169	26508249192	3
T2192NHBL	243.15	170	26508275047	3
T2193	235.70	168	26508249758	3
T2193BG	419.60	168	26508286098	3
T2193BL	419.60	168	26508281901	3
T2193BN	419.60	168	26508249765	3
T2193EP	235.70	168	26508249208	3
T2193EPBG	419.60	168	26508286104	3
T2193EPBL	419.60	168	26508281918	3
T2193EPBN	419.60	168	26508249772	3
T2193NHBL	342.80	170	26508275054	3
T2232EP	163.05	252	26508271414	4
T2232EPBN	315.95	252	26508271544	4
T2232EPORB	315.95	252	26508271551	4
T2233EP	204.60	251	26508271407	4
T2233EPBN	385.05	251	26508271568	4
T2233EPORB	385.05	251	26508271575	4
T2252EP	163.05	244	26508271391	4
T2252EPBN	315.95	244	26508271582	4
T2252EPORB	315.95	244	26508271599	4
T2253EP	204.60	243	26508271384	4
T2253EPBN	385.05	243	26508271605	4
T2253EPORB	385.05	243	26508271612	4
T2282EP	172.50	229	26508271438	4
T2282EPBN	337.85	229	26508271629	4
T2282EPORB	337.85	229	26508271636	4
T2283EP	218.15	228	26508271421	4
T2283EPBN	413.85	228	26508271643	4
T2283EPORB	413.85	228	26508271650	4
T2311	142.25	204	26508275429	3
T2311BN	268.75	204	26508275436	3
T2311NL	268.75	204	26508301418	-
T2311ORB	268.75	204	26508275443	3
T2312	208.20	203	26508275450	4
T2312BN	359.50	203	26508275467	4
T2312EP	208.20	203	26508275474	4

MODEL NUMBER	LIST PRICE	PAGE NO.	UNIVERSAL PRODUCT CODE	CASE QTY
T2312EPBN	359.50	203	26508275481	4
T2312EPNL	359.50	203	26508301425	-
T2312EPORB	359.50	203	26508275498	4
T2312NL	359.50	203	26508301449	-
T2312ORB	359.50	203	26508275535	4
T2313	266.35	202	26508275542	4
T2313BN	441.70	202	26508275559	4
T2313EP	266.35	202	26508275566	4
T2313EPBN	441.70	202	26508275573	4
T2313EPNL	441.70	202	26508301456	-
T2313EPORB	441.70	202	26508275580	4
T2313NL	441.70	202	26508301470	-
T2313ORB	441.70	202	26508275627	4
T2661	73.65	260	26508273081	3
T2662EP	93.80	259	26508273098	3
T2663EP	135.30	258	26508273111	3
T2691	142.25	185	26508230282	3
T2691BG	268.75	185	26508286128	3
T2691BN	268.75	185	26508230299	3
T2691NL	268.75	185	26508301487	-
T2691ORB	268.75	185	26508230305	3
T2692	208.20	184	26508230312	3
T2692BG	359.50	184	26508286135	3
T2692BN	359.50	184	26508230329	3
T2692EP	208.20	184	26508230336	3
T2692EPBG	359.50	184	26508286142	3
T2692EPBN	359.50	184	26508230343	3
T2692EPNL	359.50	184	26508301494	-
T2692EPORB	359.50	184	26508230350	3
T2692NL	359.50	184	26508301517	-
T2692ORB	359.50	184	26508230398	3
T2693	266.35	183	26508230404	3
T2693BG	441.70	183	26508286166	3
T2693BN	441.70	183	26508230411	3
T2693EP	266.35	183	26508230428	3
T2693EPBG	441.70	183	26508286173	3
T2693EPBN	441.70	183	26508230435	3
T2693EPNL	441.70	183	26508301524	-
T2693EPORB	441.70	183	26508230442	3
T2693NL	441.70	183	26508301548	-
T2693ORB	441.70	183	26508230480	3
T2741	80.95	236	26508261217	3
T2741BN	196.15	236	26508261224	3
T2742	103.15	235	26508261231	3
T2742BN	241.00	235	26508261248	3
T2742EP	103.15	235	26508261255	3
T2742EPBN	241.00	235	26508261262	3
T2743	148.90	234	26508261279	3
T2743BN	317.00	234	26508261286	3
T2743EP	148.90	234	26508261293	3
T2743EPBN	317.00	234	26508261309	3
T2781	100.20	192	26508288443	3
T2782EP	169.10	191	26508288450	3
T2783EP	244.05	190	26508288467	3
T2801	73.65	267	26508207055	3
T2801BN	178.35	267	26508207062	3
T2802	93.80	266	26508207079	3
T2802BN	219.10	266	26508207086	3
T2802EPBN	219.10	266	26508208311	3
T2803	135.30	265	26508207093	3
T2803BN	288.15	265	26508207109	3
T2803EPBN	288.15	265	26508208335	3
T2811	84.20	225	26508235102	3
T2811BL	203.35	225	26508301555	3
T2811BN	203.35	225	26508258323	3
T2812	127.10	224	26508235119	3
T2812BL	263.55	224	26508301562	-

MODEL NUMBER	LIST PRICE	PAGE NO.	UNIVERSAL PRODUCT CODE	CASE QTY	MODEL NUMBER	LIST PRICE	PAGE NO.	UNIVERSAL PRODUCT CODE	CASE QTY
T2812BN	263.55	224	26508258330	3	T4191BL	196.20	165	26508275061	12
T2812EP	127.10	224	26508235126	3	T4191BN	196.20	165	26508249260	12
T2812EPBL	263.55	224	26508301579	-	T4192	136.85	165	26508260326	12
T2812EPBN	263.55	224	26508258347	3	T4192BG	205.25	165	26508285879	12
T2813	183.25	223	26508235133	3	T4192BL	205.25	165	26508281659	12
T2813BL	346.20	223	26508301593	3	T4192BN	205.25	165	26508281666	12
T2813BN	346.20	223	26508258354	3	T4291	280.00	164	26508290668	3
T2813EP	183.25	223	26508235140	3	T4291BG	472.30	164	26508290705	3
T2813EPBL	346.20	223	26508301609	-	T4291BL	472.30	164	26508290712	3
T2813EPBN	346.20	223	26508258361	3	T4291BN	472.30	164	26508290729	3
T2842EP	172.50	235	26508271452	4	T4292	129.45	164	26508290736	6
T2842EPBN	337.85	235	26508271667	4	T4292BG	212.85	164	26508290743	6
T2843EP	218.15	234	26508271445	4	T4292BL	212.85	164	26508290750	6
T2843EPBN	413.85	234	26508271674	4	T4292BN	212.85	164	26508290767	6
T3111	159.60	213	26508108017	3	T4301	128.90	199	26508275726	12
T3111BN	347.05	213	26508115336	3	T4301BN	196.20	199	26508275733	12
T3111ORB	347.05	213	26508132395	3	T4301NL	196.20	199	26508301708	-
T3112	223.00	212	26508108024	3	T4301ORB	196.20	199	26508275740	12
T3112BN	458.55	212	26508115343	3	T4311	128.90	211	26508250402	6
T3112ORB	458.55	212	26508132401	3	T4311BN	196.20	211	26508250419	6
T3113	320.75	212	26508108031	3	T4311ORB	196.20	211	26508250426	6
T3113BN	562.90	212	26508115350	3	T4411	280.00	198	26508290774	3
T3113ORB	562.90	212	26508132418	3	T4411BN	472.30	198	26508290781	3
T3291	159.60	167	26508249819	3	T4411NL	472.30	198	26508290798	3
T3291BG	347.05	167	26508286197	3	T4411ORB	472.30	198	26508290804	-
T3291BN	347.05	167	26508249826	3	T4412	129.45	198	26508290811	6
T3292	250.30	166	26508249215	3	T4412BN	212.85	198	26508290828	6
T3292BG	500.25	166	26508286203	3	T4412NL	212.85	198	26508290835	6
T3292BN	500.25	166	26508249222	3	T4412ORB	212.85	198	26508290842	6
T3293	348.00	166	26508249239	3	T4501	142.25	158	26508253441	3
T3293BG	604.70	166	26508286227	3	T4501BN	268.75	158	26508253458	3
T3293BN	604.70	166	26508249246	3	T4501NL	268.75	158	26508255759	3
T3311	159.60	201	26508275634	3	T4501ORB	268.75	158	26508255766	3
T3311BN	347.05	201	26508275641	3	T4502	208.20	157	26508253465	3
T3311NL	347.05	201	26508301623	-	T4502BN	359.50	157	26508253472	3
T3311ORB	347.05	201	26508275658	3	T4502EP	208.20	157	26508253489	3
T3312NH	174.95	201	26508275665	3	T4502EPBN	359.50	157	26508253496	3
T3312NHBN	390.55	201	26508275672	3	T4502EPORB	359.50	157	26508255780	3
T3312NHNL	390.55	201	26508301630	-	T4502NL	359.50	157	26508255803	3
T3312NHORB	390.55	201	26508275689	3	T4502ORB	359.50	157	26508255810	3
T3313NH	272.65	200	26508275696	3	T4503	266.35	156	26508253519	3
T3313NHBN	494.95	200	26508275702	3	T4503BN	441.70	156	26508253526	3
T3313NHNL	494.95	200	26508301647	-	T4503EP	266.35	156	26508253533	3
T3313NHORB	494.95	200	26508275719	3	T4503EPBN	441.70	156	26508253540	3
T3691	159.60	182	26508230497	3	T4503EPORB	441.70	156	26508255834	3
T3691BG	347.05	182	26508285329	3	T4503NL	441.70	156	26508255865	3
T3691BN	347.05	182	26508230503	3	T4503ORB	441.70	156	26508255872	3
T3691NL	347.05	182	26508301654	-	T4511	128.90	153	26508253687	12
T3691ORB	347.05	182	26508230510	3	T4511BN	196.20	153	26508253694	12
T3692	250.30	181	26508230527	3	T4511NL	196.20	153	26508255889	12
T3692BG	500.25	181	26508285336	3	T4511ORB	196.20	153	26508255896	12
T3692BN	500.25	181	26508230534	3	T4512	134.25	153	26508281291	12
T3692NL	500.25	181	26508301678	-	T4512BN	205.25	153	26508281307	12
T3692ORB	500.25	181	26508230541	3	T4512NL	205.25	153	26508281314	12
T3693	348.00	181	26508230558	3	T4512ORB	205.25	153	26508281321	12
T3693BG	604.70	181	26508284643	3	T4520	352.45	148	26508253403	3
T3693BN	604.70	181	26508230565	3	T4520BN	564.05	148	26508253700	3
T3693NL	604.70	181	26508301692	-	T4520NL	564.05	148	26508255902	3
T3693ORB	604.70	181	26508230572	3	T4520ORB	564.05	148	26508255919	3
T4111	210.10	211	26508115176	3	T4524	352.45	148	26508253717	3
T4111BN	317.10	211	26508115558	3	T4524BN	564.05	148	26508253762	3
T4111ORB	317.10	211	26508132425	3	T4524NL	564.05	148	26508255926	3
T4171	126.10	307	26508201947	6	T4524ORB	564.05	148	26508255933	3
T4171BN	189.75	307	26508201954	6	T4611	128.90	180	26508230589	12
T4171ORB	189.75	307	26508201961	6	T4611BG	196.20	180	26508285862	12
T4191	128.90	165	26508249253	12	T4611BN	196.20	180	26508230596	12
T4191BG	196.20	165	26508285886	12	T4611NL	196.20	180	26508301715	-

Wholesale

Listed in numerical order

MODEL NUMBER	LIST PRICE	PAGE NO.	UNIVERSAL PRODUCT CODE	CASE QTY
T4611ORB	196.20	180	26508230602	12
T4612	134.25	180	26508281338	12
T4612BG	205.25	180	26508286241	12
T4612BN	205.25	180	26508281345	12
T4612NL	205.25	180	26508301722	-
T4612ORB	205.25	180	26508281352	12
T4691	280.00	179	26508290859	3
T4691BG	472.30	179	26508290866	3
T4691BN	472.30	179	26508290873	-
T4691NL	472.30	179	26508290880	3
T4691ORB	472.30	179	26508290897	3
T4692	129.45	179	26508290903	6
T4692BG	212.85	179	26508290910	6
T4692BN	212.85	179	26508290927	6
T4692NL	212.85	179	26508290934	-
T4692ORB	212.85	179	26508290941	6
T4943	215.80	239	26508162088	3
T4943BN	403.15	239	26508162101	3
T4943ORB	403.15	239	26508162095	3
T5191	517.00	171	26508249277	3
T5191BN	759.75	171	26508249284	3
T5220	429.05	254	26508171769	3
T5220BN	626.10	254	26508171776	3
T5220ORB	626.10	254	26508171783	3
T5225	429.05	245	26508171790	3
T5225BN	626.10	245	26508171806	3
T5225ORB	626.10	245	26508171813	3
T5245	517.00	158	26508255940	3
T5245BN	759.75	158	26508255957	3
T5245ORB	759.75	158	26508255971	3
T5269	517.00	185	26508230619	3
T5269BN	759.75	185	26508230626	3
T5269ORB	759.75	185	26508230633	3
T5501	159.60	155	26508253779	3
T5501BN	347.05	155	26508253786	3
T5501NL	347.05	155	26508256039	3
T5501ORB	347.05	155	26508256046	3
T5502	250.30	154	26508253793	3
T5502BN	500.25	154	26508253809	3
T5502NL	500.25	154	26508256053	3
T5502ORB	500.25	154	26508256060	3
T5503	348.00	154	26508253816	3
T5503BN	604.70	154	26508253823	3
T5503NL	604.70	154	26508256077	3
T5503ORB	604.70	154	26508256084	3
T6107	324.60	208	26508166031	3
T6107BN	537.55	208	26508166048	3
T6107ORB	537.55	208	26508166055	3
T6125	412.15	208	26508126820	3
T6125BN	680.15	208	26508126844	3
T6125ORB	680.15	208	26508132463	3
T6125WR	680.15	208	26508126851	3
T6173	246.30	232	26508261330	3
T6173BN	387.20	232	26508261347	3
T6193	341.55	160	26508249857	3
T6193BG	484.55	160	26508286258	3
T6193BL	484.55	160	26508275078	3
T6193BN	484.55	160	26508249291	3
T6405	352.45	194	26508275757	3
T6405BN	564.05	194	26508275764	3
T6405NL	564.05	194	26508301739	-
T6405ORB	564.05	194	26508275771	3
T6420	223.90	248	26508153130	3
T6420BN	352.00	248	26508153147	3
T6420ORB	352.00	248	26508153154	3
T6601	280.00	152	26508290958	3
T6601BN	472.30	152	26508290965	3

MODEL NUMBER	LIST PRICE	PAGE NO.	UNIVERSAL PRODUCT CODE	CASE QTY
T6601NL	472.30	152	26508290675	3
T6601ORB	472.30	152	26508290682	3
T6602	129.45	152	26508290699	6
T6602BN	212.85	152	26508290972	6
T6602NL	212.85	152	26508290989	6
T6602ORB	212.85	152	26508290996	6
T6620	223.90	238	26508162071	3
T6620BN	352.00	238	26508161012	3
T6620ORB	352.00	238	26508161029	3
T6805	246.30	226	26508264591	3
T6805BN	387.20	226	26508264607	3
T6805ORB	387.20	226	26508264614	3
T6820	223.90	262	26508207154	3
T6820BN	352.00	262	26508207161	3
T6905	352.45	174	26508230640	3
T6905BG	564.05	174	26508284650	3
T6905BN	564.05	174	26508230657	3
T6905NL	564.05	174	26508301746	-
T6905ORB	564.05	174	26508230664	3
T6906	324.60	175	26508230671	3
T6906BG	537.55	175	26508286265	3
T6906BN	537.55	175	26508230688	3
T6906NL	537.55	175	26508301753	-
T6906ORB	537.55	175	26508230695	3
T6920	259.00	219	26508235157	3
T6920BL	404.05	219	26508301760	-
T6920BN	404.05	219	26508258378	3
T8341	416.35	432	26508228555	1
T8342	425.50	431	26508228562	1
T8342EP15	425.50	431	26508228579	1
T8346	352.00	433	26508228609	4
T8346EP15	352.00	433	26508228616	4
T8350	66.35	440	26508211878	3
T8350CBN	174.05	440	26508237069	3
T8360	58.30	441	26508222775	3
T8360CBN	138.90	441	26508235652	3
T8370	49.75	440	26508211885	3
T8370CBN	126.85	440	26508235669	3
T8375	93.60	435	26508211892	3
T8375EP15	93.60	435	26508222782	3
T8375EP15CBN	184.45	435	26508235683	3
T8389	129.30	434	26508212134	3
T8389EP15	129.30	434	26508222799	3
T8389EP15CBN	245.85	434	26508235720	3
T9023	413.60	196	26508275788	3
T9023BN	644.10	196	26508275795	3
T9023NL	644.10	196	26508301791	-
T9023ORB	644.10	196	26508275801	3
T9024	657.90	197	26508275818	3
T9024BN	1,078.50	197	26508275825	3
T9024NL	1,078.50	197	26508301807	-
T9024ORB	1,078.50	197	26508275832	3
T9342EP15	609.30	430	26508257340	1
T9342GBM15	670.30	431	26508257388	1
T9346EP15	536.80	432	26508255551	4
T9346GBM15	590.45	433	26508255568	1
T9360	164.50	441	26508255582	3
T9370	128.50	440	26508255599	3
T9375	160.80	435	26508255605	3
T9375EP15	160.80	435	26508255612	3
T9389	204.60	434	26508255629	3
T9389EP15	204.60	434	26508255636	3
T62132EP	93.80	252	26508208359	12
T62133EP	135.30	251	26508208373	12
T62152EP	93.80	244	26508208397	12
T62153EP	135.30	243	26508208410	12
T62802EP	93.80	266	26508208434	12

MODEL NUMBER	LIST PRICE	PAGE NO.	UNIVERSAL PRODUCT CODE	CASE QTY	MODEL NUMBER	LIST PRICE	PAGE NO.	UNIVERSAL PRODUCT CODE	CASE QTY
T62803EP	135.30	265	26508208458	12	TS1422	256.60	345	26508258798	6
T90331	37.05	354	26508184455	12	TS1422BG	353.50	345	26508286296	6
T90331BG	119.25	354	26508286289	12	TS1422BL	353.50	345	26508301838	-
T90331BN	119.25	354	26508184509	12	TS1422BN	353.50	345	26508258804	6
T90331NL	119.25	354	26508184516	12	TS1422NL	353.50	345	26508258811	6
T90331ORB	119.25	354	26508184523	12	TS1422ORB	353.50	345	26508258828	6
T90331P	119.25	354	26508184530	12	TS2141	155.55	136	26508215029	3
T90331WR	119.25	354	26508184578	12	TS2141BN	291.05	136	26508216767	3
TL2359EP	238.95	273	26508249895	3	TS2142	227.60	129	26508215036	3
TL5265	328.55	272	26508255162	3	TS2142BN	389.20	129	26508216781	3
TS214	690.95	82	26508170267	3	TS2142EP	227.60	129	26508222256	3
TS214BN	1,041.50	82	26508170274	3	TS2142EPBN	389.20	129	26508223253	3
TS214ORB	1,041.50	82	26508170298	3	TS2143	291.20	128	26508215043	3
TS310	270.75	325	26508184707	3	TS2143BN	478.25	128	26508216804	3
TS310BN	406.15	325	26508184714	3	TS2143EP	291.20	128	26508222263	3
TS310ORB	406.15	325	26508184738	3	TS2143EPBN	478.25	128	26508223277	3
TS312	485.15	85	26508170410	3	TS2154	174.45	127	26508215050	3
TS312BN	715.60	85	26508170427	3	TS2154BN	375.80	127	26508216828	3
TS312ORB	715.60	85	26508170441	3	TS2155	243.80	126	26508215067	3
TS314	581.95	85	26508170519	3	TS2155BN	496.45	126	26508216842	3
TS314BN	766.85	85	26508170526	3	TS2156	350.70	126	26508215074	3
TS314ORB	766.85	85	26508170540	3	TS2156BN	609.45	126	26508216866	3
TS325	236.85	323	26508250488	6	TS2171	147.60	106	26508281598	12
TS325BN	348.55	323	26508250495	6	TS2172	153.20	106	26508281673	12
TS325ORB	348.55	323	26508250501	6	TS2201	201.20	121	26508291283	3
TS418	540.60	81	26508170618	3	TS2201BL	376.20	121	26508291290	3
TS418BN	836.20	81	26508170625	3	TS2201BN	376.20	121	26508291306	3
TS418ORB	836.20	81	26508170649	3	TS2202	294.55	120	26508291313	4
TS514	160.90	288	26508170762	6	TS2202BL	503.95	120	26508291320	4
TS514BN	231.95	288	26508170779	6	TS2202BN	503.95	120	26508291337	4
TS514NL	231.95	288	26508170786	3	TS2202EP	294.55	120	26508291344	4
TS514ORB	231.95	288	26508170793	6	TS2202EPBL	503.95	120	26508291351	4
TS903	564.25	92	26508215371	3	TS2202EPBN	503.95	120	26508291368	4
TS903BN	829.10	92	26508217771	3	TS2203	377.30	119	26508291405	4
TS904	911.90	93	26508215395	3	TS2203BL	590.40	119	26508291412	4
TS904BN	1,391.90	93	26508217795	3	TS2203BN	590.40	119	26508291429	4
TS923	564.25	124	26508215432	3	TS2203EP	377.30	119	26508291436	4
TS923BN	829.10	124	26508217856	3	TS2203EPBL	590.40	119	26508291443	4
TS923ORB	829.10	124	26508217863	3	TS2203EPBN	590.40	119	26508291450	4
TS925	911.90	125	26508215449	3	TS2211	172.00	133	26508215081	3
TS925BN	1,391.90	125	26508217887	3	TS2211BN	321.60	133	26508216880	3
TS925ORB	1,391.90	125	26508217894	3	TS2211ORB	321.60	133	26508216897	3
TS955	564.25	104	26508295748	-	TS2212	251.80	132	26508215098	3
TS963	452.20	122	26508215470	3	TS2212BN	430.70	132	26508216910	3
TS963BN	697.40	122	26508217931	3	TS2212EP	251.80	132	26508222164	3
TS964	719.35	123	26508215487	3	TS2212EPBN	430.70	132	26508223314	3
TS964BN	1,167.75	123	26508217955	3	TS2212EPORB	430.70	132	26508223321	3
TS983	474.80	113	26508291146	3	TS2212ORB	430.70	132	26508216927	3
TS983BL	732.20	113	26508291153	3	TS2213	322.50	131	26508215104	3
TS983BN	732.20	113	26508291160	3	TS2213BN	544.75	131	26508216941	3
TS984	755.35	114	26508291177	3	TS2213EP	322.50	131	26508222188	3
TS984BL	1,226.15	114	26508291184	3	TS2213EPBN	544.75	131	26508223376	3
TS984BN	1,226.15	114	26508291191	3	TS2213EPORB	544.75	131	26508223383	3
TS1320	160.35	345	26508219638	6	TS2213ORB	544.75	131	26508216958	3
TS1320BN	228.10	345	26508219645	6	TS2711	172.00	100	26508215111	3
TS1320NL	228.10	345	26508250754	6	TS2711BN	321.60	100	26508216989	3
TS1320ORB	228.10	345	26508219652	6	TS2712	251.80	99	26508215128	3
TS1322	160.35	345	26508219669	6	TS2712BN	430.70	99	26508216996	3
TS1322BG	228.10	345	26508285374	6	TS2712EP	251.80	99	26508222218	3
TS1322BL	228.10	345	26508301821	-	TS2712EPBN	430.70	99	26508223413	3
TS1322BN	228.10	345	26508219676	6	TS2713	322.50	98	26508215135	3
TS1322NL	228.10	345	26508250761	6	TS2713BN	544.75	98	26508217009	3
TS1322ORB	228.10	345	26508219683	6	TS2713EP	322.50	98	26508222249	3
TS1420	256.60	345	26508252543	6	TS2713EPBN	544.75	98	26508223437	3
TS1420BN	353.50	345	26508258743	6	TS3100	303.50	288	26508223581	3
TS1420NL	353.50	345	26508258750	6	TS3100BN	490.85	288	26508223598	3
TS1420ORB	353.50	345	26508258767	6	TS3101	336.30	115	26508291498	3

Wholesale

Listed in numerical order

MODEL NUMBER	LIST PRICE	PAGE NO.	UNIVERSAL PRODUCT CODE	CASE QTY
TS3101BL	524.75	115	26508291504	3
TS3101BN	524.75	115	26508291511	3
TS3102	160.90	115	26508291528	6
TS3102BL	231.95	115	26508291535	6
TS3102BN	231.95	115	26508291542	6
TS3110	336.30	288	26508184752	3
TS3110BN	524.75	288	26508184769	3
TS3110ORB	524.75	288	26508184783	3
TS3200	134.40	124	26508223604	6
TS3200BN	218.85	124	26508223628	6
TS3201	231.40	118	26508291559	3
TS3201BL	464.85	118	26508291566	3
TS3201BN	464.85	118	26508291573	3
TS3202NH	265.35	117	26508291580	4
TS3202NHBL	495.45	117	26508291597	4
TS3202NHBN	495.45	117	26508291603	4
TS3203NH	358.45	117	26508291610	4
TS3203NHBL	560.75	117	26508291627	4
TS3203NHBN	560.75	117	26508291634	4
TS3210	284.95	325	26508215715	3
TS3210BG	427.40	325	26508286371	3
TS3210BL	427.40	325	26508301999	-
TS3210BN	427.40	325	26508215845	3
TS3210NL	427.40	325	26508231319	3
TS3210ORB	427.40	325	26508215852	3
TS3211	191.90	130	26508215142	3
TS3211BN	438.20	130	26508217115	3
TS3211ORB	438.20	130	26508217122	3
TS3212	268.65	129	26508215159	3
TS3212BN	578.85	129	26508217146	3
TS3212ORB	578.85	129	26508217153	3
TS3213	386.80	129	26508215166	3
TS3213BN	711.40	129	26508217177	3
TS3213ORB	711.40	129	26508217184	3
TS3300	136.45	288	26508223635	6
TS3300BN	220.05	288	26508223642	6
TS3302BL	592.30	281	26508299203	-
TS3302TB	592.30	281	26508269930	3
TS3304BL	902.50	281	26508299210	-
TS3304TB	902.50	281	26508269947	3
TS3400	503.60	286	26508215173	3
TS3400BN	931.55	286	26508217221	3
TS3400ORB	931.55	286	26508217238	3
TS3411	286.90	291	26508215203	3
TS3411BN	494.75	291	26508217313	3
TS3411ORB	494.75	291	26508217320	3
TS3600	135.75	291	26508215258	6
TS3600BN	223.90	291	26508217511	6
TS3600ORB	223.90	291	26508217528	6
TS3661NH	561.25	304	26508266991	3
TS3661NHBL	833.20	304	26508279441	3
TS3661NHBN	833.20	304	26508279458	3
TS3661NHORB	833.20	304	26508279465	3
TS3711	191.90	307	26508215265	3
TS3711BN	438.20	307	26508217559	3
TS3713	386.80	96	26508215272	3
TS3713BN	711.40	96	26508217566	3
TS3715	268.65	96	26508215289	3
TS3715BN	578.85	96	26508217573	3
TS3760	303.50	126	26508223659	3
TS3760BN	490.85	126	26508223673	3
TS3760ORB	490.85	126	26508223680	3
TS3820	136.45	126	26508223697	6
TS3820BN	220.05	126	26508223710	6
TS3820ORB	220.05	126	26508223727	6
TS3900	290.80	124	26508223734	3
TS3900BN	485.65	124	26508223758	3

MODEL NUMBER	LIST PRICE	PAGE NO.	UNIVERSAL PRODUCT CODE	CASE QTY
TS4112	229.75	125	26508215296	3
TS4112BN	343.30	125	26508217597	3
TS4172	147.60	305	26508227749	6
TS4172BN	222.70	305	26508227756	6
TS4173	153.20	304	26508281727	12
TS4173BN	231.85	304	26508281734	12
TS4211	240.15	128	26508215302	3
TS4211BN	359.85	128	26508217610	3
TS4211ORB	359.85	128	26508217627	3
TS5205	147.60	127	26508250518	6
TS5205BN	222.70	127	26508250525	6
TS5205ORB	222.70	127	26508250532	6
TS6205	398.15	123	26508215333	3
TS6205BN	657.05	123	26508217696	3
TS6205ORB	657.05	123	26508217702	3
TS6520	385.45	121	26508215340	3
TS6520BN	610.65	121	26508217726	3
TS6720	398.15	90	26508215364	3
TS6720BN	657.05	90	26508217757	3
TS6730	404.05	90	26508221679	3
TS6730BN	748.10	90	26508221686	3
TS6925	398.15	111	26508291115	3
TS6925BL	657.05	111	26508291122	3
TS6925BN	657.05	111	26508291139	3
TS8002	398.15	103	26508264003	3
TS8002BLC	755.60	103	26508305805	3
TS8711	172.00	109	26508264010	3
TS8712	251.80	108	26508264027	3
TS8712EP	251.80	108	26508264034	3
TS8713	322.50	107	26508264041	3
TS8713EP	322.50	107	26508264058	3
TS9204	177.10	116	26508291641	12
TS9204BL	278.40	116	26508291658	12
TS9204BN	278.40	116	26508291665	12
TS9205	182.70	116	26508291672	12
TS9205BL	287.40	116	26508291689	12
TS9205BN	287.40	116	26508291696	12
TS9711	303.50	105	26508291009	3
TS9712	136.45	105	26508291016	6
TS21102	1,257.00	60	26508215593	3
TS21102BG	2,229.25	60	26508286302	3
TS21102BL	2,229.25	60	26508301845	-
TS21102BN	2,229.25	60	26508215609	3
TS21102NL	2,229.25	60	26508231210	3
TS21102ORB	2,229.25	60	26508215616	3
TS21104	1,257.00	60	26508215623	3
TS21104BG	2,229.25	60	26508286319	3
TS21104BL	2,229.25	60	26508301852	-
TS21104BN	2,229.25	60	26508215630	3
TS21104NL	2,229.25	60	26508231227	3
TS21104ORB	2,229.25	60	26508215647	3
TS22001	284.95	325	26508242438	3
TS22001BL	427.40	325	26508301869	-
TS22001BN	427.40	325	26508242445	3
TS22002	540.50	78	26508242452	3
TS22002BL	796.45	78	26508301876	-
TS22002BN	796.45	78	26508242469	3
TS22002EP	540.50	78	26508242476	3
TS22002EPBL	796.45	78	26508301883	-
TS22002EPBN	796.45	78	26508242483	3
TS22003	650.65	77	26508242513	3
TS22003BL	957.85	77	26508301890	-
TS22003BN	957.85	77	26508242520	3
TS22003EP	650.65	77	26508242537	3
TS22003EPBL	957.85	77	26508301906	-
TS22003EPBN	957.85	77	26508242544	3
TS22101	708.50	59	26508215654	3

MODEL NUMBER	LIST PRICE	PAGE NO.	UNIVERSAL PRODUCT CODE	CASE QTY	MODEL NUMBER	LIST PRICE	PAGE NO.	UNIVERSAL PRODUCT CODE	CASE QTY
TS22101BG	1,088.25	59	26508291078	3	TS32206BL	383.55	304	26508302026	-
TS22101BL	1,088.25	59	26508301913	-	TS32206BN	383.55	304	26508281697	12
TS22101BN	1,088.25	59	26508215661	3	TS32206NL	383.55	304	26508281703	12
TS22101NL	1,088.25	59	26508231234	3	TS32206ORB	383.55	304	26508281710	12
TS22101ORB	1,088.25	59	26508215678	3	TS33002	373.75	287	26508242599	3
TS22103	708.50	59	26508215685	3	TS33002BL	552.25	287	26508302033	-
TS22103BG	1,088.25	59	26508286326	3	TS33002BN	552.25	287	26508242605	3
TS22103BL	1,088.25	59	26508301920	-	TS33003	173.40	287	26508242612	6
TS22103BN	1,088.25	59	26508215692	3	TS33003BL	244.20	287	26508302040	-
TS22103NL	1,088.25	59	26508231241	3	TS33003BN	244.20	287	26508242629	6
TS22103ORB	1,088.25	59	26508215708	3	TS33101	327.75	307	26508283103	3
TS23005	261.25	305	26508250433	6	TS33101BG	491.55	307	26508285923	3
TS23005BL	374.50	305	26508301937	-	TS33101BL	491.55	307	26508302057	-
TS23005BN	374.50	305	26508250440	6	TS33101BN	491.55	307	26508283110	3
TS23006	266.80	304	26508282984	12	TS33101NL	491.55	307	26508283127	3
TS23006BL	383.55	304	26508301944	-	TS33101ORB	491.55	307	26508283134	3
TS23006BN	383.55	304	26508282991	12	TS33102NH	438.65	63	26508283141	3
TS25105	837.65	58	26508251119	3	TS33102NHBG	632.55	63	26508285916	3
TS25105BN	1,225.20	58	26508251126	3	TS33102NHBL	632.55	63	26508302064	-
TS25105ORB	1,225.20	58	26508282014	3	TS33102NHBN	632.55	63	26508283158	3
TS32001	327.75	307	26508283004	3	TS33102NHNL	632.55	63	26508283165	3
TS32001BL	491.55	307	26508301951	-	TS33102NHORB	632.55	63	26508283172	3
TS32001BN	491.55	307	26508283011	3	TS33103NH	522.45	63	26508283189	3
TS32002NH	438.65	75	26508283028	3	TS33103NHBG	745.35	63	26508286470	3
TS32002NHBL	632.55	75	26508301968	-	TS33103NHBL	745.35	63	26508302071	-
TS32002NHBN	632.55	75	26508283035	3	TS33103NHBN	745.35	63	26508283196	3
TS32003NH	522.45	75	26508283042	3	TS33103NHNL	745.35	63	26508283202	3
TS32003NHBL	745.35	75	26508301975	-	TS33103NHORB	745.35	63	26508283219	3
TS32003NHBN	745.35	75	26508283059	3	TS42106	564.75	57	26508215951	3
TS32102	540.50	66	26508215722	3	TS42106BG	865.55	57	26508286418	3
TS32102BG	796.45	66	26508286333	3	TS42106BL	865.55	57	26508302088	-
TS32102BL	796.45	66	26508299180	-	TS42106BN	865.55	57	26508215968	3
TS32102BN	796.45	66	26508215739	3	TS42106NL	865.55	57	26508231357	3
TS32102EP	540.50	66	26508218877	3	TS42106ORB	865.55	57	26508215975	3
TS32102EPBG	796.45	66	26508286340	3	TS42108	579.45	56	26508215982	3
TS32102EPBL	796.45	66	26508299173	-	TS42108BG	905.05	56	26508286425	3
TS32102EPBN	796.45	66	26508218884	3	TS42108BL	905.05	56	26508302095	-
TS32102EPNL	796.45	66	26508231258	3	TS42108BN	905.05	56	26508215999	3
TS32102EPORB	796.45	66	26508218891	3	TS42108NL	905.05	56	26508231364	3
TS32102NL	796.45	66	26508231272	3	TS42108ORB	905.05	56	26508216002	3
TS32102ORB	796.45	66	26508215777	3	TS42112	564.75	57	26508216019	3
TS32104	650.65	65	26508215784	3	TS42112BG	865.55	57	26508286432	3
TS32104BG	957.85	65	26508286357	3	TS42112BL	865.55	57	26508302101	-
TS32104BL	957.85	65	26508299159	-	TS42112BN	865.55	57	26508216026	3
TS32104BN	957.85	65	26508215791	3	TS42112NL	865.55	57	26508231371	3
TS32104EP	650.65	65	26508218914	3	TS42112ORB	865.55	57	26508216033	3
TS32104EPBG	957.85	65	26508286364	3	TS42114	579.45	56	26508216040	3
TS32104EPBL	957.85	65	26508299142	-	TS42114BG	905.05	56	26508286667	3
TS32104EPBN	957.85	65	26508218921	3	TS42114BL	905.05	56	26508302118	-
TS32104EPNL	957.85	65	26508231289	3	TS42114BN	905.05	56	26508216057	3
TS32104EPORB	957.85	65	26508218938	3	TS42114NL	905.05	56	26508231388	3
TS32104NL	957.85	65	26508231302	3	TS42114ORB	905.05	56	26508216064	3
TS32104ORB	957.85	65	26508215838	3	TS43002	554.35	69	26508242636	3
TS32110	373.75	287	26508215869	3	TS43002BL	836.20	69	26508302125	-
TS32110BG	552.25	287	26508286388	3	TS43002BN	836.20	69	26508242643	3
TS32110BL	552.25	287	26508302002	-	TS43003	528.35	69	26508242650	3
TS32110BN	552.25	287	26508215876	3	TS43003BL	839.75	69	26508281932	3
TS32110NL	552.25	287	26508231326	3	TS43003BN	839.75	69	26508242667	3
TS32110ORB	552.25	287	26508215883	3	TS50100	336.65	112	26508251133	2
TS32205	261.25	305	26508250457	6	TS50200	504.90	58	26508251140	2
TS32205BG	374.50	305	26508286395	12	TS52104	173.40	287	26508216071	6
TS32205BL	374.50	305	26508302019	-	TS52104BG	244.20	287	26508286449	6
TS32205BN	374.50	305	26508250464	6	TS52104BL	244.20	287	26508302132	-
TS32205NL	374.50	305	26508251218	6	TS52104BN	244.20	287	26508216088	6
TS32205ORB	374.50	305	26508250471	6	TS52104NL	244.20	287	26508231395	6
TS32206	266.80	304	26508281680	12	TS52104ORB	244.20	287	26508216095	6
TS32206BG	383.55	304	26508286401	12	TS93003	690.95	71	26508242735	3

Wholesale

Listed in numerical order

MODEL NUMBER	LIST PRICE	PAGE NO.	UNIVERSAL PRODUCT CODE	CASE QTY
TS93003BL	1,041.50	71	26508302149	-
TS93003BN	1,041.50	71	26508242742	3
TS93004	1,157.80	72	26508242759	3
TS93004BL	2,035.60	72	26508302156	-
TS93004BN	2,035.60	72	26508242766	3
YB0201BL	68.80	122	34584028365	24
YB0201BN	68.80	122	34584028372	24
YB0201CH	65.55	122	34584028389	24
YB0203BL	61.25	122	34584028396	24
YB0203BN	61.25	122	34584028402	24
YB0203CH	58.30	122	34584028419	24
YB0208BL	116.05	122	34584028426	6
YB0208BN	116.05	122	34584028433	6
YB0208CH	110.50	122	34584028440	6
YB0218BL	129.90	122	34584028457	6
YB0218BN	129.90	122	34584028464	6
YB0218CH	123.70	122	34584028471	6
YB0224BL	134.00	122	34584028488	6
YB0224BN	134.00	122	34584028495	6
YB0224CH	127.60	122	34584028501	6
YB0286BL	85.90	122	34584028877	6
YB0286BN	85.90	122	34584028884	6
YB0286CH	81.80	122	34584028891	6
YB0402BL	72.45	172	34584026750	24
YB0402BN	72.45	172	34584022530	24
YB0402CH	65.05	172	34584022547	24
YB0403BG	38.70	172	34584028594	24
YB0403BL	38.70	172	34584026767	24
YB0403BN	38.70	172	34584022554	24
YB0403CH	36.00	172	34584022561	24
YB0408BG	71.20	172	34584028600	6
YB0408BL	71.20	172	34584026774	6
YB0408BN	71.20	172	34584022578	6
YB0408CH	65.75	172	34584022585	6
YB0409BL	60.30	172	34584026781	6
YB0409BN	60.30	172	34584022592	6
YB0409CH	56.00	172	34584022608	6
YB0418BG	82.20	172	34584028617	6
YB0418BL	82.20	172	34584026798	6
YB0418BN	82.20	172	34584022615	6
YB0418CH	76.25	172	34584022622	6
YB0424BG	85.15	172	34584028624	6
YB0424BL	85.15	172	34584026804	6
YB0424BN	85.15	172	34584022639	6
YB0424CH	78.65	172	34584022646	6
YB0486BG	57.40	172	34584028648	6
YB0486BL	57.40	172	34584026811	6
YB0486BN	57.40	172	34584022653	6
YB0486CH	53.60	172	34584022660	6
YB0801BL	99.40	80	34584029676	-
YB0801BN	99.40	80	34584021700	24
YB0801CH	81.80	80	34584021717	24
YB0803BL	86.20	80	34584029669	-
YB0803BN	86.20	80	34584021724	24
YB0803CH	78.65	80	34584021731	24
YB0808BL	123.00	80	34584029652	-
YB0808BN	123.00	80	34584021748	6
YB0808CH	111.85	80	34584021755	6
YB0818BL	142.25	80	34584029645	-
YB0818BN	142.25	80	34584021762	6
YB0818CH	129.40	80	34584021779	6
YB0824BL	153.80	80	34584029638	-
YB0824BN	153.80	80	34584021786	6
YB0824CH	139.65	80	34584021793	6
YB0886BL	99.30	80	34584029621	-
YB0886BN	99.30	80	34584021809	6
YB0886CH	90.30	80	34584021816	6

MODEL NUMBER	LIST PRICE	PAGE NO.	UNIVERSAL PRODUCT CODE	CASE QTY
YB0892BL	257.45	80	34584029614	-
YB0892BN	257.45	80	34584021823	3
YB0892CH	225.15	80	34584021830	3
YB2101BN	47.95	231	34584024985	6
YB2101CH	29.90	231	34584024992	6
YB2101ORB	47.95	231	34584025005	6
YB2103BN	35.80	231	34584025012	24
YB2103CH	26.45	231	34584025029	24
YB2103ORB	35.80	231	34584025036	24
YB2108BN	64.40	231	34584025043	6
YB2108CH	44.05	231	34584025050	6
YB2108ORB	64.40	231	34584025067	6
YB2118BN	79.05	231	34584025074	6
YB2118CH	52.85	231	34584025098	6
YB2118ORB	79.05	231	34584025081	6
YB2124BN	83.15	231	34584025104	6
YB2124CH	58.75	231	34584025111	6
YB2124ORB	83.15	231	34584025128	6
YB2186BN	49.00	231	34584025135	6
YB2186CH	35.25	231	34584025142	6
YB2186ORB	49.00	231	34584025159	6
YB2201BN	46.25	246	34584008008	6
YB2201CH	27.40	246	34584008015	6
YB2201ORB	46.25	246	34584008022	6
YB2203BN	32.75	246	34584008039	24
YB2203CH	19.55	246	34584008046	24
YB2203ORB	32.75	246	34584008053	24
YB2208BN	58.75	246	34584008060	6
YB2208CH	34.85	246	34584008077	6
YB2208ORB	58.75	246	34584008084	6
YB2218BN	72.15	246	34584008091	6
YB2218CH	42.90	246	34584008107	6
YB2218ORB	72.15	246	34584008114	6
YB2224BN	75.80	246	34584008121	6
YB2224CH	45.10	246	34584008138	6
YB2224ORB	75.80	246	34584008145	6
YB2261BN	191.00	247	34584022226	2
YB2261CH	152.85	247	34584022233	2
YB2261ORB	191.00	247	34584022240	2
YB2262BN	267.30	247	34584022257	2
YB2262CH	213.95	247	34584022264	2
YB2262ORB	267.30	247	34584022271	2
YB2263BN	293.70	247	34584022288	2
YB2263CH	234.90	247	34584022295	2
YB2263ORB	293.70	247	34584022301	2
YB2264BN	400.90	247	34584022318	2
YB2264CH	320.85	247	34584022325	2
YB2264ORB	400.90	247	34584022332	2
YB2286BN	44.70	246	34584008152	6
YB2286CH	26.65	246	34584008169	6
YB2286ORB	44.70	246	34584008176	6
YB2303BN	35.80	237	34584024596	24
YB2303CH	26.45	237	34584024602	24
YB2308BN	64.40	237	34584024619	6
YB2308CH	44.05	237	34584024626	6
YB2318BN	79.05	237	34584024633	3
YB2318CH	52.85	237	34584024640	3
YB2324BN	83.15	237	34584024657	6
YB2324CH	58.75	237	34584024664	6
YB2386BN	49.00	237	34584024671	6
YB2386CH	35.25	237	34584024688	6
YB2401BN	46.25	268	34584016317	6
YB2401CH	27.40	268	34584016324	6
YB2403BN	32.75	268	34584016331	24
YB2403CH	19.55	268	34584016348	24
YB2408BN	58.75	268	34584016355	6
YB2408CH	34.85	268	34584016362	6

MODEL NUMBER	LIST PRICE	PAGE NO.	UNIVERSAL PRODUCT CODE	CASE QTY	MODEL NUMBER	LIST PRICE	PAGE NO.	UNIVERSAL PRODUCT CODE	CASE QTY
YB2418BN	72.15	268	34584016379	6	YB5124CH	79.90	186	34584020741	6
YB2418CH	42.90	268	34584016386	6	YB5124NL	91.10	186	34584029683	-
YB2424BN	75.80	268	34584016393	6	YB5124ORB	91.10	186	34584020758	6
YB2424CH	45.10	268	34584016409	6	YB5161BG	196.95	188	34584028792	2
YB2486BN	44.70	268	34584016416	6	YB5161BN	196.95	188	34584023834	2
YB2486CH	26.65	268	34584016423	6	YB5161CH	157.55	188	34584023841	2
YB2801BN	45.65	255	34584005663	6	YB5161NL	196.95	188	34584029751	-
YB2801CH	27.70	255	34584005601	6	YB5161ORB	196.95	188	34584023858	2
YB2801ORB	45.65	255	34584005724	6	YB5162BG	275.70	188	34584028778	2
YB2803BN	34.10	255	34584005618	24	YB5162BN	275.70	188	34584023865	2
YB2803CH	24.45	255	34584005557	24	YB5162CH	220.55	188	34584023872	2
YB2803ORB	34.10	255	34584005670	24	YB5162NL	275.70	188	34584029768	-
YB2808BN	61.25	255	34584005625	6	YB5162ORB	275.70	188	34584023889	2
YB2808CH	40.80	255	34584005564	6	YB5163BG	303.25	188	34584028761	2
YB2808ORB	61.25	255	34584005687	6	YB5163BN	303.25	188	34584023896	2
YB2818BN	75.30	255	34584005632	6	YB5163CH	242.65	188	34584023902	2
YB2818CH	49.00	255	34584005571	6	YB5163NL	303.25	188	34584029775	-
YB2818ORB	75.30	255	34584005694	6	YB5163ORB	303.25	188	34584023919	2
YB2824BN	79.20	255	34584005649	6	YB5164BG	413.50	188	34584028754	2
YB2824CH	54.45	255	34584005588	6	YB5164BN	413.50	188	34584023926	2
YB2824ORB	79.20	255	34584005700	6	YB5164CH	330.80	188	34584023933	2
YB2861BN	191.00	256	34584022356	2	YB5164NL	413.50	188	34584029782	-
YB2861CH	152.85	256	34584022363	2	YB5164ORB	413.50	188	34584023940	2
YB2861ORB	191.00	256	34584022370	2	YB5169	28.85	188	34584023957	3
YB2862BN	267.30	256	34584022387	2	YB5170BN	54.95	186	34584020765	6
YB2862CH	213.95	256	34584022394	2	YB5170CH	52.35	186	34584020772	6
YB2862ORB	267.30	256	34584022400	2	YB5170NL	54.95	186	34584029799	-
YB2863BN	293.70	256	34584022417	2	YB5170ORB	54.95	186	34584020789	6
YB2863CH	234.90	256	34584022424	2	YB5186BG	61.15	186	34584028747	6
YB2863ORB	293.70	256	34584022431	2	YB5186BN	61.15	186	34584020796	6
YB2864BN	400.90	256	34584022448	2	YB5186CH	54.45	186	34584020802	6
YB2864CH	320.85	256	34584022455	2	YB5186NL	61.15	186	34584029744	-
YB2864ORB	400.90	256	34584022462	2	YB5186ORB	61.15	186	34584020819	6
YB2886BN	46.70	255	34584005656	6	YB5201BN	49.95	159	34584023094	6
YB2886CH	32.65	255	34584005595	6	YB5201CH	43.85	159	34584023087	6
YB2886ORB	46.70	255	34584005717	6	YB5201NL	49.95	159	34584023568	6
YB2894BN	236.25	255	34584015136	2	YB5201ORB	49.95	159	34584023575	6
YB2894CH	195.90	255	34584015143	2	YB5203BN	41.55	159	34584023117	24
YB2894ORB	236.25	255	34584015150	2	YB5203CH	36.40	159	34584023100	24
YB5003CH	58.30	110	34584024701	24	YB5203NL	41.55	159	34584023582	24
YB5008CH	110.50	110	34584024718	6	YB5203ORB	41.55	159	34584023599	24
YB5012CH	115.45	110	34584024725	6	YB5208BN	76.35	159	34584023131	6
YB5018CH	123.70	110	34584024732	6	YB5208CH	66.70	159	34584023124	6
YB5024CH	127.60	110	34584024749	6	YB5208NL	76.35	159	34584023605	6
YB5086CH	81.80	110	34584024756	6	YB5208ORB	76.35	159	34584023612	6
YB5101BG	49.95	186	34584028631	24	YB5218BN	87.85	159	34584023155	6
YB5101BN	49.95	186	34584020611	24	YB5218CH	77.40	159	34584023148	6
YB5101CH	43.85	186	34584020628	24	YB5218NL	87.85	159	34584023629	6
YB5101NL	49.95	186	34584029607	-	YB5218ORB	87.85	159	34584023636	6
YB5101ORB	49.95	186	34584020635	24	YB5222BN	114.20	159	34584023179	6
YB5103BG	41.55	186	34584028846	24	YB5222CH	102.65	159	34584023162	6
YB5103BN	41.55	186	34584020642	24	YB5222NL	114.20	159	34584023643	6
YB5103CH	36.40	186	34584020659	24	YB5222ORB	114.20	159	34584023650	6
YB5103NL	41.55	186	34584029591	-	YB5224BN	91.10	159	34584023193	6
YB5103ORB	41.55	186	34584020666	24	YB5224CH	79.90	159	34584023186	6
YB5108BG	76.35	186	34584028839	6	YB5224NL	91.10	159	34584023667	6
YB5108BN	76.35	186	34584020673	6	YB5224ORB	91.10	159	34584023674	6
YB5108CH	66.70	186	34584020680	6	YB5286BN	61.15	159	34584023216	6
YB5108NL	76.35	186	34584029584	-	YB5286CH	54.45	159	34584023209	6
YB5108ORB	76.35	186	34584020697	6	YB5286NL	61.15	159	34584023681	6
YB5118BG	87.85	186	34584028822	6	YB5286ORB	61.15	159	34584023698	6
YB5118BN	87.85	186	34584020703	6	YB5401BN	56.25	217	34584006103	24
YB5118CH	77.40	186	34584020710	6	YB5401CH	49.00	217	34584006127	24
YB5118NL	87.85	186	34584029577	-	YB5401ORB	56.25	217	34584001184	24
YB5118ORB	87.85	186	34584020727	6	YB5401WR	56.25	217	34584006134	24
YB5124BG	91.10	186	34584028815	6	YB5403BN	49.50	217	34584483003	24
YB5124BN	91.10	186	34584020734	6	YB5403CH	43.65	217	34584482761	24

MODEL NUMBER	LIST PRICE	PAGE NO.	UNIVERSAL PRODUCT CODE	CASE QTY	MODEL NUMBER	LIST PRICE	PAGE NO.	UNIVERSAL PRODUCT CODE	CASE QTY
YB8203BN	66.30	134	34584011381	24	YB8424BG	170.90	68	34584028785	6
YB8203CH	58.30	134	34584011466	24	YB8424BL	170.90	68	34584029270	-
YB8203ORB	66.30	134	34584011541	24	YB8424BN	155.35	68	34584018021	6
YB8205BN	13.35	134	34584018540	48	YB8424CH	136.90	68	34584018038	6
YB8205CH	11.50	134	34584018212	48	YB8424NL	170.90	68	34584020468	6
YB8205ORB	14.50	134	34584018229	48	YB8424ORB	170.90	68	34584018045	6
YB8207BN	24.80	134	34584018557	48	YB8486BG	111.15	68	34584028709	6
YB8207CH	23.00	134	34584018236	48	YB8486BL	111.15	68	34584029287	-
YB8207ORB	26.90	134	34584018243	48	YB8486BN	101.10	68	34584018052	6
YB8208BN	121.85	134	34584011398	6	YB8486CH	88.60	68	34584018069	6
YB8208CH	110.50	134	34584011473	6	YB8486NL	111.15	68	34584020475	6
YB8208ORB	121.85	134	34584011558	6	YB8486ORB	111.15	68	34584018076	6
YB8218BN	140.25	134	34584011404	6	YB8801BN	68.80	101	34584016492	24
YB8218CH	123.70	134	34584011480	6	YB8801CH	65.55	101	34584014696	24
YB8218ORB	140.25	134	34584011565	6	YB8803BN	61.25	101	34584016508	24
YB8224BN	145.60	134	34584011428	6	YB8803CH	58.30	101	34584014702	24
YB8224CH	127.60	134	34584011503	6	YB8805BN	13.35	101	34584018250	48
YB8224ORB	145.60	134	34584011589	6	YB8805CH	11.50	101	34584018564	48
YB8261BN	206.00	135	34584018700	2	YB8807BN	24.80	101	34584018267	48
YB8261CH	164.80	135	34584018717	2	YB8807CH	23.00	101	34584018571	48
YB8261ORB	206.00	135	34584018724	2	YB8808BN	116.05	101	34584016515	6
YB8262BN	288.25	135	34584018731	3	YB8808CH	110.50	101	34584014719	6
YB8262CH	230.70	135	34584018748	3	YB8818BN	129.90	101	34584016522	6
YB8262ORB	288.25	135	34584018755	2	YB8818CH	123.70	101	34584014726	6
YB8263BN	316.85	135	34584018762	2	YB8824BN	134.00	101	34584016539	6
YB8263CH	253.45	135	34584018779	2	YB8824CH	127.60	101	34584014733	6
YB8263ORB	316.85	135	34584018786	2	YB8861BN	206.00	102	34584023964	2
YB8269	29.40	135	34584019103	3	YB8861CH	164.80	102	34584023971	2
YB8286BN	86.85	134	34584011435	6	YB8862BN	288.25	102	34584023988	2
YB8286CH	81.80	134	34584011510	6	YB8862CH	230.70	102	34584023995	2
YB8286ORB	86.85	134	34584011596	6	YB8863BN	316.85	102	34584024008	2
YB8401BG	107.35	68	34584028730	24	YB8863CH	253.45	102	34584024015	2
YB8401BL	107.35	68	34584029300	-	YB8864BN	432.55	102	34584024022	2
YB8401BN	97.60	68	34584017901	24	YB8864CH	346.10	102	34584024039	2
YB8401CH	85.80	68	34584017918	24	YB8869	29.40	102	34584024046	3
YB8401NL	107.35	68	34584020420	24	YB8886BN	85.90	101	34584016546	6
YB8401ORB	107.35	68	34584017925	24	YB8886CH	81.80	101	34584014740	6
YB8403BG	98.05	68	34584028723	24	YB9801BN	93.65	87	34584015617	-
YB8403BL	98.05	68	34584029225	-	YB9801CH	76.75	87	34584015624	3
YB8403BN	89.15	68	34584017932	24	YB9801ORB	93.65	87	34584015648	-
YB8403CH	77.90	68	34584017949	24	YB9803BN	86.85	87	34584000064	24
YB8403NL	98.05	68	34584020437	24	YB9803CH	75.40	87	34584000019	6
YB8403ORB	98.05	68	34584017956	24	YB9803ORB	86.85	87	34584003768	24
YB8405BG	19.45	68	34584028860	48	YB9805BN	15.75	87	34584018601	48
YB8405BL	19.45	68	34584029232	-	YB9805CH	13.90	87	34584018274	48
YB8405BN	17.65	68	34584021847	48	YB9805ORB	17.25	87	34584018281	48
YB8405CH	15.55	68	34584021854	48	YB9807BN	27.70	87	34584018618	48
YB8405NL	19.45	68	34584021861	48	YB9807CH	25.85	87	34584018298	48
YB8405ORB	19.45	68	34584021878	48	YB9807ORB	30.55	87	34584018304	48
YB8407BG	34.30	68	34584028853	48	YB9808BN	123.40	87	34584000224	6
YB8407BL	34.30	68	34584029249	-	YB9808CH	107.35	87	34584000217	6
YB8407BN	31.20	68	34584021885	48	YB9808ORB	123.40	87	34584003775	6
YB8407CH	29.20	68	34584021892	48	YB9818BN	142.80	87	34584000088	6
YB8407NL	34.30	68	34584021908	48	YB9818CH	123.40	87	34584000033	6
YB8407ORB	34.30	68	34584021915	48	YB9818ORB	142.80	87	34584003782	6
YB8408BG	135.45	68	34584028716	6	YB9824BN	154.10	87	34584000095	6
YB8408BL	135.45	68	34584029256	-	YB9824CH	133.55	87	34584000200	6
YB8408BN	123.20	68	34584017963	6	YB9824ORB	154.10	87	34584003799	6
YB8408CH	112.40	68	34584017970	6	YB9861BN	243.20	88	34584015433	2
YB8408NL	135.45	68	34584020444	6	YB9861CH	195.10	88	34584015440	2
YB8408ORB	135.45	68	34584017987	6	YB9861ORB	243.20	88	34584015457	2
YB8418BG	158.60	68	34584028808	6	YB9862BN	339.40	88	34584015464	2
YB8418BL	158.60	68	34584029263	-	YB9862CH	272.00	88	34584015471	2
YB8418BN	144.25	68	34584017994	6	YB9862ORB	339.40	88	34584015488	2
YB8418CH	126.95	68	34584018007	6	YB9863BN	373.65	88	34584015495	2
YB8418NL	158.60	68	34584020451	6	YB9863CH	298.20	88	34584015501	2
YB8418ORB	158.60	68	34584018014	6	YB9863ORB	373.65	88	34584015518	2

Wholesale

Listed in numerical order

MODEL NUMBER	LIST PRICE	PAGE NO.	UNIVERSAL PRODUCT CODE	CASE QTY
YB9864BN	509.70	88	34584015525	2
YB9864CH	408.05	88	34584015532	2
YB9864ORB	509.70	88	34584015549	2
YB9869	35.80	88	34584016645	-
YB9886BN	104.45	87	34584000101	6
YB9886CH	91.25	87	34584000040	6
YB9886ORB	104.45	87	34584003805	6
YG0412BN	130.65	173	34584024107	6
YG0412CH	108.20	173	34584024091	6
YG0418BG	137.05	173	34584028693	6
YG0418BN	137.05	173	34584024121	6
YG0418CH	113.05	173	34584024114	6
YG0424BG	147.80	173	34584028686	6
YG0424BN	147.80	173	34584024145	6
YG0424CH	118.05	173	34584024138	6
YG0436BN	166.45	173	34584024169	6
YG0436CH	134.40	173	34584024152	6
YG0442BN	246.45	173	34584024183	6
YG0442CH	197.10	173	34584024176	6
YG0812BL	146.35	80	34584029522	-
YG0812BN	146.35	80	34584022035	6
YG0812CH	135.45	80	34584022042	6
YG0818BL	153.50	80	34584029515	-
YG0818BN	153.50	80	34584022059	6
YG0818CH	141.55	80	34584022066	6
YG0824BL	165.65	80	34584029508	-
YG0824BN	165.65	80	34584022073	6
YG0824CH	147.80	80	34584022080	6
YG0836BL	186.50	80	34584029492	-
YG0836BN	186.50	80	34584022097	6
YG0836CH	168.35	80	34584022103	6
YG2212BN	119.50	246	34584024206	6
YG2212CH	98.05	246	34584024190	6
YG2212ORB	130.65	246	34584024213	6
YG2218BN	125.50	246	34584024237	6
YG2218CH	103.60	246	34584024220	6
YG2218ORB	137.35	246	34584024244	6
YG2224BN	136.00	246	34584024268	6
YG2224CH	108.40	246	34584024251	6
YG2224ORB	151.60	246	34584024275	6
YG2812BN	119.50	255	34584024299	6
YG2812CH	98.05	255	34584024282	6
YG2812ORB	130.65	255	34584024305	6
YG2818BN	125.50	255	34584024329	6
YG2818CH	103.60	255	34584024312	6
YG2818ORB	137.35	255	34584024336	6
YG2824BN	136.00	255	34584024350	6
YG2824CH	108.40	255	34584024343	6
YG2824ORB	151.59	255	34584024367	6
YG5112BG	130.65	187	34584028679	6
YG5112BN	130.65	187	34584025241	6
YG5112CH	108.20	187	34584025166	6
YG5112NL	130.65	187	34584029478	-
YG5112ORB	130.65	187	34584025173	6
YG5118BG	137.05	187	34584028662	6
YG5118BN	137.05	187	34584025180	6
YG5118CH	113.05	187	34584025197	6
YG5118NL	137.05	187	34584029461	-
YG5118ORB	137.05	187	34584025203	6
YG5124BG	147.80	187	34584028655	6
YG5124BN	147.80	187	34584025210	6
YG5124CH	118.05	187	34584025227	6
YG5124NL	147.80	187	34584029454	-
YG5124ORB	147.80	187	34584025234	6
YG5412BN	164.90	218	34584483683	6
YG5412CH	128.65	218	34584482648	6
YG5412ORB	164.90	218	34584007476	6

MODEL NUMBER	LIST PRICE	PAGE NO.	UNIVERSAL PRODUCT CODE	CASE QTY
YG5418BN	184.30	218	34584483690	3
YG5418CH	144.55	218	34584482655	3
YG5418ORB	184.30	218	34584007483	3
YG5424BN	203.25	218	34584483706	3
YG5424CH	159.35	218	34584482662	3
YG5424ORB	203.25	218	34584007490	3
YG5430BN	212.80	218	34584483713	3
YG5430CH	174.65	218	34584482679	3
YG5436BN	220.35	218	34584483720	3
YG5436CH	189.95	218	34584482686	3
YG5442BN	229.65	218	34584483737	3
YG5442CH	205.25	218	34584482693	3
YG6412BL	164.90	205	34584029942	-
YG6412BN	164.90	205	34584027252	6
YG6412CH	128.65	205	34584027269	6
YG6412NL	164.90	205	34584029447	-
YG6412ORB	164.90	205	34584027276	6
YG6418BL	184.30	205	34584029430	-
YG6418BN	184.30	205	34584027283	6
YG6418CH	144.55	205	34584027290	6
YG6418NL	184.30	205	34584029423	-
YG6418ORB	184.30	205	34584027306	6
YG6424BL	203.25	205	34584029416	-
YG6424BN	203.25	205	34584027313	3
YG6424CH	159.35	205	34584027320	6
YG6424NL	203.25	205	34584029409	-
YG6424ORB	203.25	205	34584027337	6
YG8812BN	146.35	101	34584022110	6
YG8812CH	135.45	101	34584022127	6
YG8818BN	153.50	101	34584022134	6
YG8818CH	141.55	101	34584022141	6
YG8824BN	165.65	101	34584022158	6
YG8824CH	147.80	101	34584022165	6
YG8836BN	186.50	101	34584022172	6
YG8836CH	168.35	101	34584022189	6

Kitchen and Bar



Weymouth® Kitchen / S73004NL / S5510NL / S3945NL

Please see moen.ca/consumer-support/warranty
for complete product warranty information.

KITCHEN





Water on your wavelength.

Start the flow of water with just the wave of a hand. Even during the messiest and busiest moments in the kitchen, you're still in control with MotionSense Wave™. Stay on the move, and your water will move when you want it to.

Kitchen Faucets with MotionSense®

		MODEL NUMBER	LIST PRICE	FINISH/ COLOUR	CASE QTY	
ST6®	ONE-HANDLE PULLDOWN KITCHEN FAUCET - MOTIONSENSE	<ul style="list-style-type: none"> • application: one hole • overall height: 17.25" • connection size: 3/8" • connection type: compression • number of functions: two-function • spray type: aerated stream; powerful cleaning rinse • water usage: 1.5 gpm (5.7 L/min) max. • handle mounting: right only • hose length: 68" • AC adapter sold separately 	S72308EC	1,080.80	Chrome	3
			S72308ESRS ●	1,221.75	Spot Resist Stainless	3
				AC ADAPTER SOLD SEPARATELY		
			169031	172.20	N/A	12



motionsense®

POWERCLEAN

reflex

DURALOCK®

DURALAST®

ALIGN®	ONE-HANDLE PULLDOWN KITCHEN FAUCET - MOTIONSENSE	<ul style="list-style-type: none"> • application: one or three hole • overall height: 15.63" • connection size: 3/8" • connection type: compression • number of functions: two-function • spray type: aerated stream; powerful cleaning rinse • water usage: 1.5 gpm (5.7 L/min) max. • handle mounting: right only • hose length: 68" • AC adapter sold separately 	7565EC	851.70	Chrome	3
			7565ESRS ●	937.50	Spot Resist Stainless	3
				DECK PLATE SOLD SEPARATELY		
			141002	55.35	Chrome	6
	141002SRS ●	61.65	Spot Resist Stainless	6		
		AC ADAPTER SOLD SEPARATELY				
	169031	172.20	N/A	12		



motionsense®

POWERCLEAN

reflex

DURALOCK®

DURALAST®

BRANTFORD™	ONE-HANDLE PULLDOWN KITCHEN FAUCET - MOTIONSENSE	<ul style="list-style-type: none"> • application: one or three hole • overall height: 15.50" • connection size: 3/8" • connection type: compression • number of functions: three-function • spray type: aerated stream; pause function; powerful cleaning rinse • water usage: 1.5 gpm (5.7 L/min) max. • handle mounting: right only • hose length: 68" • deck plate: included • AC adapter sold separately 	7185EC	803.20	Chrome	3
			7185ESRS ●	884.05	Spot Resist Stainless	3
			7185EORB	884.05	Oil Rubbed Bronze	3
				AC ADAPTER SOLD SEPARATELY		
	169031	172.20	N/A	12		



motionsense®

POWERCLEAN

reflex

DURALOCK®

DURALAST®

ARBOR®	ONE-HANDLE PULLDOWN KITCHEN FAUCET - MOTIONSENSE	<ul style="list-style-type: none"> • application: one or three hole • overall height: 15.50" • connection size: 3/8" • connection type: compression • number of functions: three-function • spray type: aerated stream; pause function; powerful cleaning rinse • water usage: 1.5 gpm (5.7 L/min) max. • handle mounting: right only • hose length: 68" • deck plate: included • AC adapter sold separately 	7594EC	803.20	Chrome	3
			7594ESRS ●	884.05	Spot Resist Stainless	3
			7594EORB	884.05	Oil Rubbed Bronze	3
				AC ADAPTER SOLD SEPARATELY		
	169031	172.20	N/A	12		



motionsense®

POWERCLEAN

reflex

DURALOCK®

DURALAST®

NOTES

- Spot Resist Stainless Finish **SPOT RESIST**

POWERCLEAN Power Clean

motionsense® MotionSense® Hands-free Kitchen Faucet

reflex Self-Retracting Spray Hose

DURALOCK Duralock™ Quick Connections

DURALAST Duralast® Cartridge

Deck Extension kits available on page 370.

Bar/Prep faucets available. See page 44-47.

WANT TO ADD WATER FILTRATION OR A SOAP DISPENSER IN THE KITCHEN? SEE page 49-52.

Kitchen Faucets with MotionSense Wave™

	MODEL NUMBER	LIST PRICE	FINISH/ COLOUR	CASE QTY
ALIGN®  <ul style="list-style-type: none"> • application: one or three hole • overall height: 22.50" • connection size: 3/8" • connection type: compression • number of functions: two-function • spray type: aerated stream; powerful cleaning rinse • water usage: 1.5 gpm (5.7 L/min) max. • handle mounting: right only • hose length: 68" 	ONE-HANDLE PULLDOWN SPRING KITCHEN FAUCET - MOTIONSENSE WAVE			
	5923EWC	743.90	Chrome	3
	NEW! 5923EWSRS ●	852.60	Spot Resist Stainless	3
	NEW! 5923EWBL	852.60	Matte Black	3
	DECKPLATES SOLD SEPARATELY			
	141002	55.35	Chrome	6
	NEW! 141002SRS ●	61.65	Spot Resist Stainless	6
	141002BL	61.65	Matte Black	6
	AC ADAPTERS SOLD SEPARATELY			
	169031	172.20		12



ARBOR®  <ul style="list-style-type: none"> • application: one or three hole • overall height: 15.70" • connection size: 3/8" • connection type: compression • number of functions: three-function • spray type: aerated stream; powerful cleaning rinse; pause function • water usage: 1.5 gpm (5.7 L/min) max. • handle mounting: right only • hose length: 68" • deckplate: included 	ONE-HANDLE PULLDOWN KITCHEN FAUCET - MOTIONSENSE WAVE			
	7594EWC	644.85	Chrome	3
	NEW! 7594EWSRS ●	721.40	Spot Resist Stainless	3
	7594EWORB	721.40	Oil Rubbed Bronze	3
	NEW! 7594EWBL	721.40	Matte Black	3
	AC ADAPTERS SOLD SEPARATELY			
	169031	172.20		12



BRANTFORD™  <ul style="list-style-type: none"> • application: one or three hole • overall height: 15.70" • connection size: 3/8" • connection type: compression • number of functions: three-function • spray type: aerated stream; powerful cleaning rinse; pause function • water usage: 1.5 gpm (5.7 L/min) max. • handle mounting: right only • hose length: 68" • deckplate: included 	ONE-HANDLE PULLDOWN KITCHEN FAUCET - MOTIONSENSE WAVE			
	NEW! 7185EWC	644.85	Chrome	3
	NEW! 7185EWSRS ●	721.40	Spot Resist Stainless	3
	7185EWORB	721.40	Oil Rubbed Bronze	3
	AC ADAPTERS SOLD SEPARATELY			
	169031	172.20		12



SLEEK™  <ul style="list-style-type: none"> • application: one or three hole • overall height: 15.56" • connection size: 3/8" • connection type: compression • number of functions: two-function • spray type: aerated stream; powerful cleaning rinse • water usage: 1.5 gpm (5.7 L/min) max. • handle mounting: right only • hose length: 68" • deckplate: included 	ONE-HANDLE PULLDOWN KITCHEN FAUCET - MOTIONSENSE WAVE			
	7864EWC	609.45	Chrome	3
	NEW! 7864EWSRS ●	677.75	Spot Resist Stainless	3
	NEW! 7864EWBL	677.75	Matte Black	3
	AC ADAPTERS SOLD SEPARATELY			
	169031	172.20		12



NOTES

● Spot Resist Stainless Finish **SPOT RESIST**

motion sense MotionSense Wave™ Hands-free Kitchen Faucet

POWERCLEAN™ Power Clean

reflex Self-Retracting Spray Hose

DURALOCK® Duralock® Quick Connections

DURALAST Duralast® Cartridge

Bar/Prep faucets available. See page 44-47.

WANT TO ADD WATER FILTRATION OR A SOAP DISPENSER IN THE KITCHEN? SEE page 49-52.

KITCHEN

Waterhill®
 Weymouth®
 90°™
 Nio™ **NEW!**
 STō®
 Etch™
 Paterson™ **NEW!**
 Aberdeen™
 Woodmere®
 Tilt™
 Voss™
 Notch™
 Align®
 Riley™
 Brantford™
 Genta™
 Arbor®
 Camerist®
 Sleek™
 Belfield™
 Chateau®
 Moen II®

Kitchen Faucets

Bring elegance to your home with kitchen faucet selections from Moen. From the sophistication of period traditional to the streamlined refinement of minimalist contemporary, you'll find a host of amazing ways to be expressive in the kitchen. Moen kitchen faucets combine meaningful innovations with an exceptional variety of attractive styles and dazzling finishes.



		MODEL NUMBER	LIST PRICE	FINISH/ COLOUR	CASE QTY
WATERHILL®	TWO-HANDLE KITCHEN FAUCET				
	<ul style="list-style-type: none"> • application: two or four hole • overall height: 11.47" • connection size: 1/2" • connection type: IPS • spray type: aerated stream • water usage: 1.5 gpm (5.7 L/min) max. • side spray: included • can be installed with or without side spray 	S713	1,123.00	Chrome	3
		S713SRS ●	1,500.75	Spot Resist Stainless	3
		S713ORB	1,500.75	Oil Rubbed Bronze	3
		S713WR	1,500.75	Wrought Iron	3
			DURALOCK® DURALAST®		
WATERHILL®	TWO-HANDLE KITCHEN FAUCET				
	<ul style="list-style-type: none"> • application: four hole • overall height: 12.25" • connection size: 1/2" • connection type: IPS • spray type: aerated stream • water usage: 1.5 gpm (5.7 L/min) max. • side spray: included 	S712	793.00	Chrome	2
		S712SRS ●	1,064.10	Spot Resist Stainless	2
		S712ORB	1,064.10	Oil Rubbed Bronze	2
			DURALOCK® DURALAST®		
WATERHILL®	ONE-HANDLE KITCHEN FAUCET				
	<ul style="list-style-type: none"> • application: three hole • overall height: 12.25" • connection size: 3/8" • connection type: compression • spray type: aerated stream • water usage: 1.5 gpm (5.7 L/min) max. • side spray: included 	S711	681.60	Chrome	2
		S711SRS ●	869.75	Spot Resist Stainless	3
		S711ORB	869.75	Oil Rubbed Bronze	2
			DURALOCK® DURALAST®		

Deck Extension kits available on page 370.

Bar/Prep faucets available. See page 44-47.

WANT TO ADD WATER FILTRATION OR A SOAP DISPENSER IN THE KITCHEN? SEE page 49-52.

NOTES

- Spot Resist Stainless Finish **SPOT RESIST**
- DURALOCK® Duralock™ Quick Connections
- DURALAST® Duralast® Cartridge

Kitchen Faucets

All Polished Nickel and Brushed Gold faucet components feature the LifeShine® Non-Tarnish Finish.

		MODEL NUMBER	LIST PRICE	FINISH/ COLOUR	CASE QTY
	WEYMOUTH® ONE-HANDLE KITCHEN FAUCET <ul style="list-style-type: none"> • application: two hole • overall height: 10.50" • connection size: 3/8" • connection type: compression • spray type: aerated stream • water usage: 1.5 gpm (5.7 L/min) max. • handle mounting: right only • side spray: included • can be installed with or without side spray 	S72101	885.05	Chrome	3
		S72101NL	1,183.30	Polished Nickel	3
		S72101SRS ●	1,183.30	Spot Resist Stainless	3
		S72101ORB	1,183.30	Oil Rubbed Bronze	3
		S72101BG	1,183.30	Brushed Gold	3



DURALOCK® DURALAST®

	WEYMOUTH® ONE-HANDLE PULLDOWN KITCHEN FAUCET <ul style="list-style-type: none"> • metal spray wand • application: one hole • overall height: 16.73" • connection size: 3/8" • connection type: compression • number of functions: four-function • spray type: aerated stream; powerful cleaning rinse; boosted stream, boosted rinse • water usage: 1.5 gpm (5.7 L/min) max. • handle mounting: right only • hose length: 68" 	S73004	651.55	Chrome	3
		S73004NL	866.45	Polished Nickel	3
		S73004SRS ●	866.45	Spot Resist Stainless	3
		S73004BG	866.45	Brushed Gold	3
		S73004ORB	866.45	Oil Rubbed Bronze	3

NEW! Ships Q2



POWERBOOST reflex™ DURALOCK® DURALAST®

	90 DEGREE™ ONE-HANDLE PULLOUT KITCHEN FAUCET <ul style="list-style-type: none"> • application: one hole • overall height: 12.38" • connection size: 3/8" • connection type: compression • number of functions: three-function • spray type: aerated stream; pause function; powerful cleaning rinse • water usage: 1.5 gpm (5.7 L/min) max. • handle mounting: left or right • hose length: 59" 	S7597C	778.05	Chrome	3
		S7597SRS ●	985.70	Spot Resist Stainless	3



DURALOCK® DURALAST®

	90 DEGREE™ ONE-HANDLE KITCHEN FAUCET <ul style="list-style-type: none"> • application: one hole • overall height: 12.00" • connection size: 3/8" • connection type: compression • spray type: aerated stream • water usage: 1.5 gpm (5.7 L/min) max. • handle mounting: left or right 	S7170	506.65	Chrome	3



DURALAST®

	NIO™ ONE-HANDLE PULLDOWN KITCHEN FAUCET <ul style="list-style-type: none"> • application: one hole • overall height: 18.21" • connection size: 3/8" • connection type: compression • number of functions: two-function • spray type: aerated stream; powerful cleaning rinse • water usage: 1.5 gpm (5.7 L/min) max. • handle mounting: right only • hose length: 68" • secondary two-tone handle option included 	S75005	762.70	Chrome	3
		S75005BL	976.25	Matte Black	3
		S75005SRS ●	976.25	Spot Resist Stainless	3
		<small>S75005 secondary handle option: Chrome/Matte Black S75005BL secondary handle option: Matte Black/Brushed Gold S75005SRS secondary handle option: Spot Resist Stainless/Matte Black</small>			

NEW! Ships Q2



POWERCLEAN reflex™ DURALOCK® DURALAST®

Deck Extension kits available on page 370.

Bar/Prep faucets available. See page 44-47.

WANT TO ADD WATER FILTRATION OR A SOAP DISPENSER IN THE KITCHEN? SEE page 49-52.

NOTES

- Spot Resist Stainless Finish 
- DURALOCK® Duralock™ Quick Connections
- DURALAST® Duralast® Cartridge

KITCHEN

Kitchen Faucets

		MODEL NUMBER	LIST PRICE	FINISH/ COLOUR	CASE QTY
	<ul style="list-style-type: none"> • application: one hole • overall height: 17.25" • connection size: 3/8" • connection type: compression • number of functions: two-function • spray type: aerated stream; powerful cleaning rinse • water usage: 1.5 gpm (5.7 L/min) max. • handle mounting: right only • hose length: 68" • AC adapter sold separately 	S72308EC	1,080.80	Chrome	3
		S72308ESRS ●	1,221.75	Spot Resist Stainless	3
				AC ADAPTER SOLD SEPARATELY	
		169031	172.20	N/A	12



motionsense® POWERCLEAN reflex|| DURALOCK® DURALAST™

		MODEL NUMBER	LIST PRICE	FINISH/ COLOUR	CASE QTY
	<ul style="list-style-type: none"> • application: one hole • overall height: 17.25" • connection size: 3/8" • connection type: compression • number of functions: two-function • spray type: aerated stream; powerful cleaning rinse • water usage: 1.5 gpm (5.7 L/min) max. • handle mounting: right only • hose length: 68" 	S72308	691.60	Chrome	3
		S72308BL	843.75	Matte Black	3
		S72308SRS ●	909.10	Spot Resist Stainless	3
		S72308BG	909.10	Brushed Gold	3
		S72308BLC*	1,045.45	Matte Black/Chrome	3



NEW! POWERBOOST Ships Q3 reflex|| DURALOCK® DURALAST™

		MODEL NUMBER	LIST PRICE	FINISH/ COLOUR	CASE QTY
	<ul style="list-style-type: none"> • application: one hole • overall height: 17.19" • connection size: 3/8" • connection type: compression • number of functions: two-function • spray type: aerated stream; powerful cleaning rinse • water usage: 1.5 gpm (5.7 L/min) max. • handle mounting: right only • hose length: 68" 	S72608	660.45	Chrome	3
		S72608SRS ●	875.20	Spot Resist Stainless	3



POWERCLEAN reflex|| DURALOCK® DURALAST™

		MODEL NUMBER	LIST PRICE	FINISH/ COLOUR	CASE QTY
	<ul style="list-style-type: none"> • application: one hole • overall height: 17.25" • connection size: 3/8" • connection type: compression • number of functions: two-function • spray type: aerated stream; powerful cleaning rinse • water usage: 1.5 gpm (5.7 L/min) max. • handle mounting: right only • hose length: 68" 	S72003	632.40	Chrome	3
		S72003BL	839.05	Matte Black	3
		S72003SRS ●	839.05	Spot Resist Stainless	3



NEW! Ships Q2 POWERBOOST reflex|| DURALOCK® DURALAST™















NOTES

- Spot Resist Stainless Finish **SPOT RESIST**
- POWERCLEAN**™ Power Clean
- POWERBOOST**™ Powerboost™
- motion**sense® MotionSense® Hands-free Kitchen Faucet
- reflex**|| Self-Retracting Spray Hose
- DURALOCK**™ Duralock® Quick Connections
- DURALAST**™ Duralast® Cartridge
- *Ships Q3

Deck Extension kits available on page 370.

Bar/Prep faucets available. See page 44-47.

WANT TO ADD WATER FILTRATION OR A SOAP DISPENSER IN THE KITCHEN? SEE page 49-52.

		MODEL NUMBER	LIST PRICE	FINISH/ COLOUR	CASE QTY	
	ABERDEEN™ ONE-HANDLE PULLDOWN KITCHEN FAUCET <ul style="list-style-type: none"> • application: two hole • overall height: 14.63" • connection size: 3/8" • connection type: compression • number of functions: three-function • spray type: aerated stream; pause function; powerful cleaning rinse • water usage: 1.5 gpm (5.7 L/min) max. • hose length: 68" 	7590C	631.90	Chrome	2	
		7590CSL	844.55	Classic Stainless	2	
		7590ORB	844.55	Oil Rubbed Bronze	2	
		 POWERCLEAN reflex  DURALOCK® DURALAST®				
	WOODMERE® ONE-HANDLE PULLDOWN KITCHEN FAUCET <ul style="list-style-type: none"> • application: one hole • overall height: 16.88" • connection size: 3/8" • connection type: compression • number of functions: three-function • spray type: aerated stream; pause function; powerful cleaning rinse • water usage: 1.5 gpm (5.7 L/min) max. • handle mounting: right only • hose length: 68" 	7615C	618.65	Chrome	3	
		7615SRS ●	827.85	Spot Resist Stainless	3	
		7615ORB	827.85	Oil Rubbed Bronze	3	
		 POWERCLEAN reflex  DURALOCK® DURALAST®				
	TILT™ ONE-HANDLE PULLOUT KITCHEN FAUCET <ul style="list-style-type: none"> • application: one hole • overall height: 11.92 " • connection size: 3/8" • connection type: compression • number of functions: two-function • spray type: aerated stream; powerful cleaning rinse • water usage: 1.5 gpm (5.7 L/min) max. • hose length: 59" 	7626C	529.40	Chrome	3	
		7626SRS ●	718.30	Spot Resist Stainless	3	
		 DURALOCK® DURALAST®				
	VOSS™ ONE-HANDLE PULLOUT KITCHEN FAUCET <ul style="list-style-type: none"> • application: one hole • overall height: 12.30" • connection size: 3/8" • connection type: compression • number of functions: two-function • spray type: aerated stream; powerful cleaning rinse • water usage: 1.5 gpm (5.7 L/min) max. • hose length: 68" 	9125C	508.70	Chrome	3	
		9125SRS ●	686.55	Spot Resist Stainless	3	
		9125ORB	686.55	Oil Rubbed Bronze	3	
		 POWERCLEAN reflex  DURALOCK® DURALAST®				
	NOTCH™ ONE-HANDLE PULLDOWN KITCHEN FAUCET <ul style="list-style-type: none"> • application: one or three hole • overall height: 16.25" • connection size: 3/8" • connection type: compression • number of functions: three-function • spray type: aerated stream; pause function; powerful cleaning rinse • water usage: 1.5 gpm (5.7 L/min) max. • handle mounting: right only • hose length: 68" 	9124C	515.75	Chrome	3	
		9124SRS ●	696.00	Spot Resist Stainless	3	
		9124ORB	696.00	Oil Rubbed Bronze	3	
		DECK PLATE SOLD SEPARATELY				
		157328	60.00	Chrome	6	
		157328SRS ●	85.15	Spot Resist Stainless	6	
157328ORB	85.15	Oil Rubbed Bronze	6			
 POWERBOOST reflex  DURALOCK® DURALAST®						

Deck Extension kits available on page 370.

Bar/Prep faucets available. See page 44-47.

WANT TO ADD WATER FILTRATION OR A SOAP DISPENSER IN THE KITCHEN? SEE page 49-52.

NOTES

- Spot Resist Stainless Finish 
- POWERCLEAN™** Power Clean
- POWERBOOST™** Powerboost™
- reflex™** Self-Retracting Spray Hose
- DURALOCK™** Duralock® Quick Connections
- DURALAST™** Duralast® Cartridge

KITCHEN

Kitchen Faucets

		MODEL NUMBER	LIST PRICE	FINISH/ COLOUR	CASE QTY		
	ALIGN® ONE-HANDLE PULLDOWN KITCHEN FAUCET - MOTIONSENSE®	<ul style="list-style-type: none"> • application: one or three hole • overall height: 15.63" • connection size: 3/8" • connection type: compression • number of functions: two-function • spray type: aerated stream; powerful cleaning rinse • water usage: 1.5 gpm (5.7 L/min) max. • handle mounting: right only • hose length: 68" • AC adapter sold separately 	7565EC	851.70	Chrome	3	
			7565ESRS ●	937.50	Spot Resist Stainless	3	
		DECK PLATE SOLD SEPARATELY					
		141002	55.35	Chrome	6		
		141002SRS ●	61.65	Spot Resist Stainless	6		
		AC ADAPTER SOLD SEPARATELY					
		169031	172.20	N/A	12		
			motionSense®	POWERCLEAN	reflex	DURALOCK®	DURALAST®

		MODEL NUMBER	LIST PRICE	FINISH/ COLOUR	CASE QTY		
	ALIGN® ONE-HANDLE PULLDOWN SPRING KITCHEN FAUCET - MOTIONSENSE WAVE	<ul style="list-style-type: none"> • application: one or three hole • overall height: 22.50" • connection size: 3/8" • connection type: compression • number of functions: two-function • spray type: aerated stream; powerful cleaning rinse • water usage: 1.5 gpm (5.7 L/min) max. • handle mounting: right only • hose length: 68" 	5923EWC	743.90	Chrome	3	
			5923EWSRS ●	852.60	Spot Resist Stainless	3	
			5923EWBL	852.60	Matte Black	3	
		DECK PLATE SOLD SEPARATELY					
		141002	55.35	Chrome	6		
		141002SRS ●	61.65	Spot Resist Stainless	6		
		141002BL	61.65	Matte Black	6		
		AC ADAPTER SOLD SEPARATELY					
		169031	172.20	N/A	12		
			motionSense WAVE	POWERCLEAN	reflex	DURALOCK®	DURALAST®

		MODEL NUMBER	LIST PRICE	FINISH/ COLOUR	CASE QTY		
	ALIGN® ONE-HANDLE PRE-RINSE SPRING PULLDOWN FAUCET	<ul style="list-style-type: none"> • application: one hole • overall height: 21.90" • connection size: 3/8" • connection type: compression • number of functions: two-function • spray type: aerated stream; powerful cleaning rinse • water usage: 1.5 gpm (5.7 L/min) max. • handle mounting: right only • hose length: 68" 	5923	582.45	Chrome	3	
			5923SRS ●	753.85	Spot Resist Stainless	3	
			5923BL	753.85	Matte Black	3	
		DECK PLATE SOLD SEPARATELY					
		141002	55.35	Chrome	6		
		141002SRS ●	61.65	Spot Resist Stainless	6		
		141002BL	61.65	Matte Black	6		
			NEW POWERBOOST Ships Q3	reflex	DURALOCK®	DURALAST®	

		MODEL NUMBER	LIST PRICE	FINISH/ COLOUR	CASE QTY		
	ALIGN® ONE-HANDLE PULLDOWN KITCHEN FAUCET	<ul style="list-style-type: none"> • application: one or three hole • overall height: 15.63" • connection size: 3/8" • connection type: compression • number of functions: two-function • spray type: aerated stream; powerful cleaning rinse • water usage: 1.5 gpm (5.7 L/min) max. • handle mounting: right only • hose length: 68" 	7565	497.80	Chrome	3	
			7565SRS ●	645.10	Spot Resist Stainless	3	
			7565BL	645.10	Matte Black	3	
			7565BG	645.10	Brushed Gold	3	
		DECK PLATE SOLD SEPARATELY					
		141002	55.35	Chrome	6		
		141002SRS ●	61.65	Spot Resist Stainless	6		
		141002BL	61.65	Matte Black	6		
		141002BG	61.65	Brushed Gold	6		
			NEW POWERBOOST Ships Q3	reflex	DURALOCK®	DURALAST®	

NOTES

● Spot Resist Stainless Finish **SPOT RESIST****POWERCLEAN** Power Clean**POWERBOOST** Powerboost™**motionSense** MotionSense® Hands-free Kitchen Faucet**motionSense WAVE** MotionSense Wave™ Hands-free Kitchen Faucet**reflex** Self-Retracting Spray Hose**DURALOCK** Duralock® Quick Connections**DURALAST** Duralast® Cartridge

Deck Extension kits available on page 370.

Bar/Prep faucets available. See page 44-47.

**WANT TO ADD WATER FILTRATION OR A SOAP DISPENSER
IN THE KITCHEN? SEE page 49-52**

		MODEL NUMBER	LIST PRICE	FINISH/ COLOUR	CASE QTY
ALIGN® 	ONE-HANDLE KITCHEN FAUCET				
	<ul style="list-style-type: none"> • application: two or four hole • overall height: 15.31" • connection size: 3/8" • connection type: compression • spray type: aerated stream • water usage: 1.5 gpm (5.7 L/min) max. • handle mounting: right only • side spray: included 	7165 7165SRS ●	409.75 538.85	Chrome Spot Resist Stainless	3 3
		DECK PLATE SOLD SEPARATELY			
		141002 141002SRS ●	55.35 61.65	Chrome Spot Resist Stainless	6 6
	 DURALOCK® DURALAST® SPOT RESIST				
	ONE-HANDLE KITCHEN FAUCET				
	<ul style="list-style-type: none"> • application: one or three hole • overall height: 15.31" • connection size: 3/8" • connection type: compression • spray type: aerated stream • water usage: 1.5 gpm (5.7 L/min) max. • handle mounting: right only 	7365 7365SRS ●	356.75 470.10	Chrome Spot Resist Stainless	3 3
		DECK PLATE SOLD SEPARATELY			
		141002 141002SRS ●	55.35 61.65	Chrome Spot Resist Stainless	6 6
	 DURALAST® SPOT RESIST				
RILEY™ 	ONE-HANDLE PULLDOWN KITCHEN FAUCET				
	<ul style="list-style-type: none"> • application: one or three hole • overall height: 16.06" • connection size: 3/8" • connection type: compression • number of functions: two-function • spray type: aerated stream; powerful cleaning rinse • water usage: 1.5 gpm (5.7 L/min) max. • handle mounting: right only • hose length: 68" 	7402C 7402SRS ●	492.95 632.85	Chrome Spot Resist Stainless	3 3
		DECK PLATE SOLD SEPARATELY			
		157328 157328SRS ●	60.00 85.15	Chrome Spot Resist Stainless	6 6
	 POWERCLEAN reflex reflex reflex DURALOCK® DURALAST®				
BRANTFORD™ 	ONE-HANDLE PULLDOWN KITCHEN FAUCET - MOTIONSENSE®				
	<ul style="list-style-type: none"> • application: one or three hole • overall height: 15.50" • connection size: 3/8" • connection type: compression • number of functions: three-function • spray type: aerated stream; pause function; powerful cleaning rinse • water usage: 1.5 gpm (5.7 L/min) max. • handle mounting: right only • hose length: 68" • deck plate: included • AC adapter sold separately 	7185EC 7185ESRS ● 7185EORB	803.20 884.05 884.05	Chrome Spot Resist Stainless Oil Rubbed Bronze	3 3 3
		AC ADAPTER SOLD SEPARATELY			
		169031	172.20	N/A	12
	 motion sense® POWERCLEAN reflex reflex DURALOCK® DURALAST®				

Deck Extension kits available on page 370.
Bar/Prep faucets available. See page 44-47.













WANT TO ADD WATER FILTRATION OR A SOAP DISPENSER IN THE KITCHEN? SEE page 49-52

NOTES

- Spot Resist Stainless Finish **SPOT RESIST**
- POWERCLEAN™** Power Clean
- motion sense®** MotionSense® Hands-free Kitchen Faucet
- reflex reflex** Self-Retracting Spray Hose
- DURALOCK®** Duralock® Quick Connections
- DURALAST™** Duralast® Cartridge

KITCHEN

Kitchen Faucets

		MODEL NUMBER	LIST PRICE	FINISH/ COLOUR	CASE QTY
BRANTFORD™ ONE-HANDLE PULLDOWN KITCHEN FAUCET - MOTIONSENSE WAVE					
 	<ul style="list-style-type: none"> • application: one or three hole • overall height: 15.70" • connection size: 3/8" • connection type: compression • number of functions: three-function • spray type: aerated stream; powerful cleaning rinse; pause function • water usage: 1.5 gpm (5.7 L/min) max. • handle mounting: right only • hose length: 68" • deckplate: included 	7185EWC	644.85	Chrome	3
		7185EWSRS ●	721.40	Spot Resist Stainless	3
		7185EWORB	721.40	Oil Rubbed Bronze	3
		169031	172.20	AC ADAPTERS SOLD SEPARATELY	12
	 motion sense <small>WAVE</small>	POWERCLEAN	reflex	DURALOCK®	DURALAST®
BRANTFORD™ ONE-HANDLE PULLDOWN KITCHEN FAUCET					
 	<ul style="list-style-type: none"> • application: one or three hole • overall height: 15.50" • connection size: 3/8" • connection type: compression • number of functions: three-function • spray type: aerated stream; pause function; powerful cleaning rinse • water usage: 1.5 gpm (5.7 L/min) max. • handle mounting: right only • hose length: 68" • deck plate: included 	7185C	484.95	Chrome	3
		7185SRS ●	624.55	Spot Resist Stainless	3
		7185ORB	624.55	Oil Rubbed Bronze	3
			 POWERBOOST	reflex	DURALOCK®
BRANTFORD™ ONE-HANDLE PULLOUT KITCHEN FAUCET					
 	<ul style="list-style-type: none"> • application: one hole • overall height: 12.94" • connection size: 3/8" • connection type: compression • number of functions: two-function • spray type: aerated stream; powerful cleaning rinse • water usage: 1.5 gpm (5.7 L/min) max. • hose length: 68" • deck plate: included 	7295C	473.20	Chrome	3
		7295SRS ●	610.30	Spot Resist Stainless	3
		7295ORB	610.30	Oil Rubbed Bronze	3
			 POWERCLEAN	reflex	DURALOCK®
GENTA™ ONE-HANDLE PULLDOWN KITCHEN FAUCET					
 	<ul style="list-style-type: none"> • application: one or three hole • overall height: 16.00" • connection size: 3/8" • connection type: compression • number of functions: two-function • spray type: aerated stream; powerful cleaning rinse • water usage: 1.5 gpm (5.7 L/min) max. • handle mounting: right only • hose length: 68" • deckplate: included 	7882	481.35	Chrome	3
		7882SRS ●	616.55	Spot Resist Stainless	3
		7882BL	616.55	Matte Black	3
			 POWERBOOST	reflex	DURALOCK®
					<small>Ships Q3</small>

NOTES

● Spot Resist Stainless Finish **SPOT RESIST****POWERCLEAN** Power Clean**POWERBOOST** Powerboost™**motion**sense MotionSense Wave™ Hands-free Kitchen Faucet**reflex** Self-Retracting Spray Hose**DURALOCK** Duralock® Quick Connections**DURALAST** Duralast® Cartridge

Deck Extension kits available on page 370.

Bar/Prep faucets available. See page 44-47.

**WANT TO ADD WATER FILTRATION OR A SOAP DISPENSER
IN THE KITCHEN? SEE page 49-52**

	MODEL NUMBER	LIST PRICE	FINISH/ COLOUR	CASE QTY	
	ARBOR® ONE-HANDLE PULLDOWN KITCHEN FAUCET - MOTIONSENSE				
	• application: one or three hole	7594EC	803.20	Chrome	3
	• overall height: 15.50"	7594ESRS ●	884.05	Spot Resist Stainless	3
	• connection size: 3/8"	7594EORB	884.05	Oil Rubbed Bronze	3
	• connection type: compression	AC ADAPTER SOLD SEPARATELY			
• number of functions: three-function	169031	172.20	N/A	12	
• spray type: aerated stream; pause function; powerful cleaning rinse					
• water usage: 1.5 gpm (5.7 L/min) max.					
• handle mounting: right only					
• hose length: 68"					
• deck plate: included					
• AC adapter sold separately					

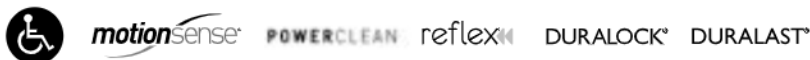

	MODEL NUMBER	LIST PRICE	FINISH/ COLOUR	CASE QTY	
	ARBOR® ONE-HANDLE PULLDOWN KITCHEN FAUCET - MOTIONSENSE WAVE				
	• application: one or three hole	7594EWC	644.85	Chrome	3
	• overall height: 15.70"	7594EWSRS ●	721.40	Spot Resist Stainless	3
	• connection size: 3/8"	7594EWOVB	721.40	Oil Rubbed Bronze	3
	• connection type: compression	NEW! 7594EWBL	721.40	Matte Black	3
• number of functions: three-function	AC ADAPTERS SOLD SEPARATELY				
• spray type: aerated stream; powerful cleaning rinse; pause function	169031	172.20		12	
• water usage: 1.5 gpm (5.7 L/min) max.					
• handle mounting: right only					
• hose length: 68"					
• deckplate: included					



	MODEL NUMBER	LIST PRICE	FINISH/ COLOUR	CASE QTY	
	ARBOR® ONE-HANDLE PULLDOWN KITCHEN FAUCET				
	• application: one or three hole	7594C	484.95	Chrome	3
	• overall height: 15.50"	7594BL	624.55	Matte Black	3
	• connection size: 3/8"	7594SRS ●	624.55	Spot Resist Stainless	3
	• connection type: compression	7594ORB	624.55	Oil Rubbed Bronze	3
• number of functions: three-function					
• spray type: aerated stream; pause function; powerful cleaning rinse					
• water usage: 1.5 gpm (5.7 L/min) max.					
• handle mounting: right only					
• hose length: 68"					
• deck plate: included					



	MODEL NUMBER	LIST PRICE	FINISH/ COLOUR	CASE QTY	
	ARBOR® ONE-HANDLE PULLOUT KITCHEN FAUCET				
	• application: one or three hole	7294C	473.20	Chrome	3
	• overall height: 12.13"	7294BL	570.15	Matte Black	3
	• connection size: 3/8"	7294SRS ●	610.30	Spot Resist Stainless	3
	• connection type: compression	7294ORB	610.30	Oil Rubbed Bronze	3
• number of functions: three-function					
• spray type: aerated stream; pause function; powerful cleaning rinse					
• water usage: 1.5 gpm (5.7 L/min) max.					
• handle mounting: right only					
• hose length: 59"					
• deck plate: included					



NOTES











- Spot Resist Stainless Finish **SPOT RESIST**
- POWERCLEAN™** Power Clean
- POWERBOOST™** Powerboost™
- motionSense®** MotionSense® Hands-free Kitchen Faucet
- motionSense Wave™** MotionSense Wave™ Hands-free Kitchen Faucet
- reflex™** Self-Retracting Spray Hose
- DURALOCK®** Duralock® Quick Connections
- DURALAST®** Duralast® Cartridge

Deck Extension kits available on page 370.
Bar/Prep faucets available. See page 44-47.

WANT TO ADD WATER FILTRATION OR A SOAP DISPENSER IN THE KITCHEN? SEE page 49-52

KITCHEN

Kitchen Faucets

		MODEL NUMBER	LIST PRICE	FINISH/ COLOUR	CASE QTY	
	ARBOR®	ONE-HANDLE KITCHEN FAUCET				
		<ul style="list-style-type: none"> • application: two or four hole • overall height: 15.50" • connection size: 3/8" • connection type: compression • spray type: aerated stream • water usage: 1.5 gpm (5.7 L/min) max. • handle mounting: right only • deck plate: included • side spray: included • can be installed with or without side spray 	7790	401.15	Chrome	3
			7790SRS ●	523.75	Spot Resist Stainless	3
						 DURALOCK® DURALAST®
	CAMERIST®	ONE-HANDLE PULLOUT KITCHEN FAUCET				
		<ul style="list-style-type: none"> • application: one or three hole • overall height: 12.42" • connection size: 3/8" • connection type: compression • number of functions: two-function • spray type: aerated stream; powerful cleaning rinse • water usage: 1.5 gpm (5.7 L/min) max. • hose length: 68" • deck plate: included 	7545C	458.85	Chrome	3
			7545SRS ●	585.40	Spot Resist Stainless	3
			7545ORB	585.40	Oil Rubbed Bronze	3
					 POWERCLEAN reflex DURALOCK® DURALAST®	
	CAMERIST®	ONE-HANDLE KITCHEN FAUCET				
		<ul style="list-style-type: none"> • application: three hole • overall height: 8.50" • connection size: 3/8" • connection type: compression • spray type: aerated stream • water usage: 1.5 gpm (5.7 L/min) max. • deck plate: included • side spray: included 	7835	282.10	Chrome	3
			7835SRS ●	405.90	Spot Resist Stainless	3
					 DURALOCK® DURALAST®	
	CAMERIST®	ONE-HANDLE KITCHEN FAUCET				
		<ul style="list-style-type: none"> • application: two or four hole • overall height: 8.50" • connection size: 3/8" • connection type: compression • spray type: aerated stream • water usage: 1.5 gpm (5.7 L/min) max. • deck plate: included • side spray: included 	7840	282.10	Chrome	3
			7840SRS ●	405.90	Spot Resist Stainless	3
			7840ORB	405.90	Oil Rubbed Bronze	3
					 DURALOCK® DURALAST®	
	CAMERIST®	ONE-HANDLE KITCHEN FAUCET				
		<ul style="list-style-type: none"> • application: one or three hole • overall height: 8.50" • connection size: 3/8" • connection type: compression • spray type: aerated stream • water usage: 1.5 gpm (5.7 L/min) max. • deck plate: included 	7825	243.35	Chrome	3
			7825SRS ●	364.60	Spot Resist Stainless	3
			7825ORB	364.60	Oil Rubbed Bronze	3
					 DURALAST®	

Deck Extension kits available on page 370.

Bar/Prep faucets available. See page 44-47.



**WANT TO ADD WATER FILTRATION OR A SOAP DISPENSER
IN THE KITCHEN? SEE page 49-52**

NOTES



- Spot Resist Stainless Finish 
- POWERCLEAN™** Power Clean
- DURALOCK™** Duralock™ Quick Connections
- DURALAST™** Duralast® Cartridge



Kitchen Faucets

		MODEL NUMBER	LIST PRICE	FINISH/ COLOUR	CASE QTY
	SLEEK™ ONE-HANDLE PULLDOWN KITCHEN FAUCET - MOTIONSENSE WAVE				
	<ul style="list-style-type: none"> • application: one or three hole • overall height: 15.56" • connection size: 3/8" • connection type: compression • number of functions: two-function • spray type: aerated stream; powerful cleaning rinse • water usage: 1.5 gpm (5.7 L/min) max. • handle mounting: right only • hose length: 68" • deckplate: included 	7864EWC	609.45	Chrome	3
		7864EWSRS ●	677.75	Spot Resist Stainless	3
		7864EWBL	677.75	Matte Black	3
		AC ADAPTERS SOLD SEPARATELY			
		169031	172.20		12
	 POWERCLEAN reflex	DURALOCK®	DURALAST®		

	SLEEK™ ONE-HANDLE PULLDOWN KITCHEN FAUCET				
	<ul style="list-style-type: none"> • application: one or three hole • overall height: 15.56" • connection size: 3/8" • connection type: compression • number of functions: two-function • spray type: aerated stream; powerful cleaning rinse • water usage: 1.5 gpm (5.7 L/min) max. • handle mounting: right only • hose length: 68" • deckplate: included 	7864	449.55	Chrome	3
		7864BL	580.90	Matte Black	3
		7864SRS ●	580.90	Spot Resist Stainless	3
	 POWERBOOST reflex	DURALOCK®	DURALAST®		
		Ships Q3			

	METHOD™ ONE-HANDLE PULLOUT KITCHEN FAUCET				
	<ul style="list-style-type: none"> • application: one or three hole • overall height: 9.04" • connection size: 3/8" • connection type: compression • number of functions: two-function • spray type: aerated stream; powerful cleaning rinse • water usage: 1.5 gpm (5.7 L/min) max. • hose length: 68" • deckplate: included 	7585C	353.10	Chrome	3
		7585SRS ●	481.25	Spot Resist Stainless	3
	 POWERCLEAN	DURALOCK®	DURALAST®		

	BELFIELD™ ONE-HANDLE KITCHEN FAUCET				
	<ul style="list-style-type: none"> • application: one or three hole • overall height: 12.13" • connection size: 3/8" • connection type: compression • spray type: aerated stream • water usage: 1.5 gpm (5.7 L/min) max. • deck plate: included 	7240C	327.40	Chrome	3
		7240SRS ●	447.70	Spot Resist Stainless	3
		7240ORB	447.70	Oil Rubbed Bronze	3
	 DURALOCK®	DURALAST®			

	<ul style="list-style-type: none"> • application: two or four hole • overall height: 12.13" • connection size: 3/8" • connection type: compression • spray type: aerated stream • water usage: 1.5 gpm (5.7 L/min) max. • deck plate: included • side spray: included 	7245C	380.65	Chrome	3
		7245SRS ●	520.60	Spot Resist Stainless	3
		7245ORB	520.60	Oil Rubbed Bronze	3
		 POWERCLEAN	DURALOCK®	DURALAST®	

NOTES

● Spot Resist Stainless Finish **SPOT RESIST**

POWERCLEAN™ Power Clean

POWERBOOST Powerboost™

motion sense MotionSense Wave™ Hands-free Kitchen Faucet

reflex Self-Retracting Spray Hose

DURALOCK® Duralock® Quick Connections

DURALAST Duralast® Cartridge













Deck Extension kits available on page 370.

Bar/Prep faucets available. See page 44-47.

WANT TO ADD WATER FILTRATION OR A SOAP DISPENSER IN THE KITCHEN? SEE page 49-52

KITCHEN

Kitchen Faucets

		MODEL NUMBER	LIST PRICE	FINISH/ COLOUR	CASE QTY
	BELFIELD™ TWO-HANDLE KITCHEN FAUCET <ul style="list-style-type: none"> • application: three hole • overall height: 9.34" • connection size: 1/2" • connection type: IPS • spray type: aerated stream • water usage: 1.5 gpm (5.7 L/min) max. • deck plate: included 	7250C	309.50	Chrome	3
		7250SRS ●	423.35	Spot Resist Stainless	3
		7250ORB	423.35	Oil Rubbed Bronze	3
		 DURALOCK®			
	<ul style="list-style-type: none"> • application: four hole • overall height: 9.34" • connection size: 1/2" • connection type: IPS • spray type: aerated stream • water usage: 1.5 gpm (5.7 L/min) max. • deck plate: included • side spray: included 	7255C	361.10	Chrome	3
		7255SRS ●	492.20	Spot Resist Stainless	3
		7255ORB	492.20	Oil Rubbed Bronze	3
		 POWERCLEAN DURALOCK®			
	CHATEAU® ONE-HANDLE KITCHEN FAUCET <ul style="list-style-type: none"> • application: four hole • overall height: 8.50" • connection size: 3/8" • connection type: compression • spray type: aerated stream • water usage: 1.5 gpm (5.7 L/min) max. • side spray: included 	7430	232.00	Chrome	6
		 DURALOCK® DURALAST®			
	<ul style="list-style-type: none"> • application: three hole • overall height: 8.50" • connection size: 3/8" • connection type: compression • spray type: aerated stream • water usage: 1.5 gpm (5.7 L/min) max. • side spray: included 	7434	232.00	Chrome	6
		 DURALOCK® DURALAST®			
	<ul style="list-style-type: none"> • application: one hole • overall height: 8.31" • connection size: 3/8" • connection type: compression • spray type: aerated stream • water usage: 1.5 gpm (5.7 L/min) max. 	7423	190.70	Chrome	6
		 DURALAST®			
	<ul style="list-style-type: none"> • application: three hole • overall height: 8.50" • connection size: 3/8" • connection type: compression • spray type: aerated stream • water usage: 1.5 gpm (5.7 L/min) max. 	7425	185.50	Chrome	6
		 DURALAST®			











Deck Extension kits available on page 370.

Bar/Prep faucets available. See page 44-47.

**WANT TO ADD WATER FILTRATION OR A SOAP DISPENSER
IN THE KITCHEN? SEE page 49-52**

NOTES

- Spot Resist Stainless Finish 
- POWERCLEAN®** Power Clean
- DURALOCK®** Duralock® Quick Connections
- DURALAST®** Duralast® Cartridge

		MODEL NUMBER	LIST PRICE	FINISH/ COLOUR	CASE QTY
CHATEAU®	TWO-HANDLE KITCHEN FAUCET				
	<ul style="list-style-type: none"> • application: four hole • overall height: 6.50" • connection size: 1/2" • connection type: IPS • spray type: aerated stream • water usage: 1.5 gpm (5.7 L/min) max. • side spray: included 	7907	192.10	Chrome	6
	 DURALOCK®				
	<ul style="list-style-type: none"> • application: three hole • overall height: 6.50" • connection size: 1/2" • connection type: IPS • spray type: aerated stream • water usage: 1.5 gpm (5.7 L/min) max. 	7906	154.25	Chrome	6
					
	<ul style="list-style-type: none"> • application: four hole • overall height: 6.50" • connection size: 1/2" • connection type: IPS • spray type: aerated stream • water usage: 1.5 gpm (5.7 L/min) max. • side spray: included 	7910	160.60	Chrome	12
	DURALOCK®				
MOEN II®	TWO-HANDLE KITCHEN FAUCET				
	<ul style="list-style-type: none"> • application: three-hole • quick connect • small lever handles • spout swings • water usage: 1.5 gpm (5.7 L/min) max. 	77924	109.45	Chrome	12
					
	<ul style="list-style-type: none"> • application: three-hole • quick connect • acrylic handles • spout swings • water usage: 1.5 gpm (5.7 L/min) max. 	77926	109.45	Chrome	12
	<ul style="list-style-type: none"> • application: three-hole • quick connect • chrome handles • spout swings • water usage: 1.5 gpm (5.7 L/min) max. 	77925	109.45	Chrome	12
	<ul style="list-style-type: none"> • application: three-hole • connection size: 1/2" • chrome handles • spout swings • water usage: 1.5 gpm (5.7 L/min) max. 	77922	109.45	Chrome	12

Bar/Prep faucets available. See page 44-47.

WANT TO ADD WATER FILTRATION OR A SOAP DISPENSER IN THE KITCHEN? SEE page 49-52

NOTES

DURALOCK® Duralock™ Quick Connections

KITCHEN

Kitchen Compliments

KITCHEN



Lighting fixtures are available in seven of the most popular Moen collections.

Kitchen Compliments is about creating a kitchen without compromise. Moen offers exceptional products that deliver all the style and functionality required for a dream kitchen — now with the convenience of getting it all from one, trusted brand. That means guaranteed style compatibility, guaranteed quality and guaranteed satisfaction.

Bundling creates excellent opportunities to cross-sell coordinating products.

You Can Offer Your Customers



New soap dispenser designs coordinate with traditional, transitional and modern style options to coordinate with décor.



Sip™ Beverage Faucets provide clean, filtered water at the kitchen sink or a separate beverage sink while hiding the filter under the cabinet.



Moen bar faucets, pot fillers and filtering faucets are guaranteed to match our kitchen faucets in finishes, performance and quality.

Who Knew?

The Quick-Connect Wiring System from Moen easily and seamlessly coordinates stylish lighting from the 90™ and Voss™ collections with our kitchen and bath collections. Additional Moen lighting collections include: Brantford®, Eva™, Iso™, Rothbury™ and Waterhill®.



Our towel bars, towel rings, hooks, knobs, pulls and other accessories create consistent style throughout the kitchen.





Traditional

Modern

Pot Fillers

The pot filler is the ultimate epicurean luxury, with all the details needed to ensure convenient flow control over a cooktop. They are available in traditional and modern styles to coordinate with any décor preference.



		MODEL NUMBER	LIST PRICE	FINISH/ COLOUR	CASE QTY
TRADITIONAL POT FILLER					
 <ul style="list-style-type: none"> • application: one hole • spout reach: 24.00" • connection size: 1/2" • connection type: IPS • spray type: aerated stream • water usage: 5.5 gpm (21 L/min) max. 		S664	837.80	Chrome	3
		S664SRS ●	1,171.25	Spot Resist Stainless	3
		S664ORB	1,171.25	Oil Rubbed Bronze	3
		S664BG	1,171.25	Brushed Gold	3
		NEW! S664BL	1,171.25	Matte Black	3
		NEW! S664NL	1,171.25	Polished Nickel	-
	Ships Q2				
					
MODERN POT FILLER					
 <ul style="list-style-type: none"> • application: one hole • spout reach: 24.00" • connection size: 1/2" • connection type: IPS • spray type: aerated stream • water usage: 5.5 gpm (21 L/min) max. 		S665	837.80	Chrome	3
		S665SRS ●	1,171.25	Spot Resist Stainless	3
		S665BG	1,171.25	Brushed Gold	3
		NEW! S665BL	1,171.25	Matte Black	3
					

Bar/Prep faucets available. See page 44-47.

WANT TO ADD WATER FILTRATION OR A SOAP DISPENSER IN THE KITCHEN? SEE page 49-52.

NOTES

● Spot Resist Stainless Finish **SPOT RESIST**

Bar/Prep Faucets

All Polished Nickel and Brushed Gold faucet components feature the LifeShine® Non-Tarnish Finish.

KITCHEN

Weymouth®

90 Degree™

Nio™ **NEW!**

Etch™

Paterson™ **NEW!**

STō®

Notch™

Align®

Brantford™

Arbor®







Camerist®

Chateau®

Bar/Prep Kitchen Faucets

Perfect for secondary sinks, bar/prep kitchen faucets combine design and functionality. Available in array of design options, Moen bar/prep kitchen faucets match perfectly with almost any decorating style.



		MODEL NUMBER	LIST PRICE	FINISH/ COLOUR	CASE QTY
WEYMOUTH® ONE-HANDLE BAR FAUCET					
	<ul style="list-style-type: none"> • application: one hole • overall height: 7.81" • connection size: 3/8" • connection type: compression • spray type: aerated stream • water usage: 1.5 gpm (5.7 L/min) max. • handle mounting: right only 	S62101	509.05	Chrome	3
		S62101NL	778.30	Polished Nickel	3
		S62101SRS ●	778.30	Spot Resist Stainless	3
		S62101ORB	778.30	Oil Rubbed Bronze	3
		S62101BG	778.30	Brushed Gold	3
		 DURALAST®			
WEYMOUTH® ONE-HANDLE PULLDOWN BAR FAUCET					
NEW! Ships Q2 	<ul style="list-style-type: none"> • application: one hole • overall height: 14.65" • connection size: 3/8" • connection type: compression • number of functions: two-function • spray type: aerated stream; powerful cleaning rinse • water usage: 1.5 gpm (5.7 L/min) max. • handle mounting: right only • hose length: 68" 	S53004	579.85	Chrome	3
		S53004NL	771.10	Polished Nickel	3
		S53004SRS ●	771.10	Spot Resist Stainless	3
		S53004BG	771.10	Brushed Gold	3
		S53004ORB	771.10	Oil Rubbed Bronze	3
		 POWERCLEAN reflex DURALOCK® DURALAST®			
90 DEGREE™ ONE-HANDLE BAR FAUCET					
	<ul style="list-style-type: none"> • application: one hole • overall height: 11.00" • connection size: 3/8" • connection type: compression • spray type: aerated stream • water usage: 1.5 gpm (5.7 L/min) max. • handle mounting: left or right 	S5170	455.65	Chrome	3
		S5170SRS ●	590.60	Spot Resist Stainless	3
 DURALAST®					

NOTES

● Spot Resist Stainless Finish **SPOT RESIST**

- POWERCLEAN** Power Clean
- reflex** Self-Retracting Spray Hose
- DURALOCK** Duralock® Quick Connections
- DURALAST** Duralast® Cartridge

Deck Extension kits available on page 370.

WANT TO ADD WATER FILTRATION OR A SOAP DISPENSER IN THE KITCHEN? SEE page 49-52.

Bar/Prep Faucets

All Polished Nickel and Brushed Gold faucet components feature the LifeShine® Non-Tarnish Finish.

		MODEL NUMBER	LIST PRICE	FINISH/ COLOUR	CASE QTY
NIO™ ONE-HANDLE BAR FAUCET					
 <p>NEW! Ships Q2</p> <ul style="list-style-type: none"> • application: one hole • overall height: 13.96" • connection size: 3/8" • connection type: compression • number of functions: two-function • spray type: aerated stream; powerful cleaning rinse • water usage: 1.5 gpm (5.7 L/min) max. • handle mounting: right only 		S55005	678.80	Chrome	3
		S55005BL	868.90	Matte Black	3
		S55005SRS ●	868.90	Spot Resist Stainless	3
	 POWERCLEAN DURALAST™				
ETCH™ ONE-HANDLE PULLDOWN BAR FAUCET					
 <ul style="list-style-type: none"> • application: one hole • overall height: 15.50" • connection size: 3/8" • connection type: compression • number of functions: two-function • spray type: aerated stream; powerful cleaning rinse • water usage: 1.5 gpm (5.7 L/min) max. • handle mounting: right only • hose length: 68" 		S62608	575.60	Chrome	3
		S62608SRS ●	769.10	Spot Resist Stainless	3
		 POWERCLEAN reflex reflex DURALOCK™ DURALAST™			
PATERSON™ ONE-HANDLE PULLDOWN BAR FAUCET					
 <p>NEW! Ships Q2</p> <ul style="list-style-type: none"> • application: one hole • overall height: 14.30" • connection size: 3/8" • connection type: compression • number of functions: two-function • spray type: aerated stream; powerful cleaning rinse • water usage: 1.5 gpm (5.7 L/min) max. • handle mounting: right only • hose length: 68" • secondary handle option included 		S52003	556.25	Chrome	3
		S52003BL	720.40	Matte Black	3
		S52003SRS ●	720.40	Spot Resist Stainless	3
	 POWERCLEAN reflex reflex DURALOCK™ DURALAST™				
STō® ONE-HANDLE PULLDOWN BAR FAUCET					
 <ul style="list-style-type: none"> • application: one hole • overall height: 14.63" • connection size: 3/8" • connection type: compression • number of functions: two-function • spray type: aerated stream; powerful cleaning rinse • water usage: 1.5 gpm (5.7 L/min) max. • handle mounting: right only • hose length: 68" 		S62308	616.35	Chrome	3
		S62308BL	759.40	Matte Black	3
		S62308SRS ●	797.95	Spot Resist Stainless	3
		S62308BG	797.95	Brushed Gold	3
		NEW! S62308BLC*	917.65	Matte Black/Chrome	3
	 NEW! POWERBOOST Ships Q3 reflex reflex DURALOCK™ DURALAST™				

KITCHEN

NOTES

● Spot Resist Stainless Finish **SPOT RESIST**

- POWERCLEAN™** Power Clean
- POWERBOOST™** Powerboost™
- reflex reflex** Self-Retracting Spray Hose
- DURALOCK™** Duralock® Quick Connections
- DURALAST™** Duralast® Cartridge
- *Ships Q3

Deck Extension kits available on page 370.

WANT TO ADD WATER FILTRATION OR A SOAP DISPENSER IN THE KITCHEN? SEE page 49-52.

Bar/Prep Faucets

		MODEL NUMBER	LIST PRICE	FINISH/ COLOUR	CASE QTY	
	NOTCH™ ONE-HANDLE PULLDOWN BAR FAUCET <ul style="list-style-type: none"> • application: one or three hole • overall height: 14.50" • connection size: 3/8" • connection type: compression • number of functions: two-function • spray type: aerated stream; powerful cleaning rinse • water usage: 1.5 gpm (5.7 L/min) max. • handle mounting: right only • hose length: 68" 	6124C	489.50	Chrome	3	
		6124SRS ●	665.65	Spot Resist Stainless	3	
		6124ORB	665.65	Oil Rubbed Bronze	3	
		DECK PLATE SOLD SEPARATELY				
		157328	60.00	Chrome	6	
		157328SRS ●	85.15	Spot Resist Stainless	6	
		157328ORB	85.15	Oil Rubbed Bronze	6	



POWERCLEAN reflex **DURALOCK** **DURALAST**

		MODEL NUMBER	LIST PRICE	FINISH/ COLOUR	CASE QTY	
	ALIGN® ONE-HANDLE PULLDOWN BAR FAUCET <ul style="list-style-type: none"> • application: one or three hole • overall height: 13.75" • connection size: 3/8" • connection type: compression • number of functions: two-function • spray type: aerated stream; powerful cleaning rinse • water usage: 1.5 gpm (5.7 L/min) max. • handle mounting: right only • hose length: 68" 	5965	474.85	Chrome	3	
		5965SRS ●	615.90	Spot Resist Stainless	3	
		5965BL	615.90	Matte Black	3	
		5965BG	615.90	Brushed Gold	3	
		DECK PLATE SOLD SEPARATELY				
		141002	55.35	Chrome	6	
		141002SRS ●	61.65	Spot Resist Stainless	6	
		141002BL	61.65	Matte Black	6	
		141002BG	61.65	Brushed Gold	6	



NEW POWERBOOST Ships Q3 reflex **DURALOCK** **DURALAST**

		MODEL NUMBER	LIST PRICE	FINISH/ COLOUR	CASE QTY	
	BRANTFORD™ ONE-HANDLE PULLDOWN BAR FAUCET <ul style="list-style-type: none"> • application: one or three hole • overall height: 14.38" • connection size: 3/8" • connection type: compression • number of functions: two-function • spray type: aerated stream; powerful cleaning rinse • water usage: 1.5 gpm (5.7 L/min) max. • handle mounting: right only • hose length: 68" 	5985	461.75	Chrome	3	
		5985SRS ●	596.05	Spot Resist Stainless	3	
		5985ORB	596.05	Oil Rubbed Bronze	3	
		DECK PLATE SOLD SEPARATELY				
		141002	55.35	Chrome	6	
		141002SRS ●	61.65	Spot Resist Stainless	6	
		141002ORB	61.65	Oil Rubbed Bronze	-	



POWERCLEAN reflex **DURALOCK** **DURALAST**

		MODEL NUMBER	LIST PRICE	FINISH/ COLOUR	CASE QTY	
	ARBOR® ONE-HANDLE PULLDOWN BAR FAUCET <ul style="list-style-type: none"> • application: one or three hole • overall height: 14.38" • connection size: 3/8" • connection type: compression • number of functions: two-function • spray type: aerated stream; powerful cleaning rinse • water usage: 1.5 gpm (5.7 L/min) max. • handle mounting: right only • hose length: 68" 	5995	461.75	Chrome	3	
		5995BL	596.05	Matte Black	3	
		5995SRS ●	596.05	Spot Resist Stainless	3	
		5995ORB	596.05	Oil Rubbed Bronze	3	
		DECK PLATE SOLD SEPARATELY				
		141002	55.35	Chrome	6	
		141002BL	61.65	Matte Black	6	
		141002SRS ●	61.65	Spot Resist Stainless	6	
		141002ORB	61.65	Oil Rubbed Bronze	-	



POWERCLEAN reflex **DURALOCK** **DURALAST**

NOTES

- Spot Resist Stainless Finish **SPOT RESIST**
- POWERCLEAN** Power Clean
- POWERBOOST** Powerboost™
- reflex Self-Retracting Spray Hose
- DURALOCK** Duralock® Quick Connections
- DURALAST** Duralast® Cartridge

Deck Extension kits available on page 370.

WANT TO ADD WATER FILTRATION OR A SOAP DISPENSER IN THE KITCHEN? SEE page 49-52.

Bar/Prep Faucets

		MODEL NUMBER	LIST PRICE	FINISH/ COLOUR	CASE QTY	
	CAMERIST® ONE-HANDLE BAR FAUCET <ul style="list-style-type: none"> • application: two hole • overall height: 11.00" • connection size: 3/8" • connection type: compression • spray type: aerated stream • water usage: 1.5 gpm (5.7 L/min) max. 					
			4905	256.55	Chrome	3
			4905SRS ●	359.90	Spot Resist Stainless	3
			4905ORB	359.90	Oil Rubbed Bronze	3
	 DURALOCK® DURALAST®					
	CHATEAU® TWO-HANDLE BAR FAUCET <ul style="list-style-type: none"> • application: two hole • overall height: 10.50" • connection size: 1/2" • connection type: IPS • spray type: aerated stream • water usage: 1.5 gpm (5.7 L/min) max. 	4903	121.30	Chrome	12	
						
	<ul style="list-style-type: none"> • application: two hole • overall height: 10.50" • connection size: 3/8" • connection type: compression • spray type: aerated stream • water usage: 1.5 gpm (5.7 L/min) max. 	4904	228.95	Chrome	3	
		 DURALOCK® DURALAST®				

KITCHEN



Deck Extension kits available on page 370.

WANT TO ADD WATER FILTRATION OR A SOAP DISPENSER IN THE KITCHEN? SEE page 49-52.

NOTES

- Spot Resist Stainless Finish **SPOT RESIST**
- DURALOCK® Duralock® Quick Connections
- DURALAST® Duralast® Cartridge

Laundry Faucets

		MODEL NUMBER	LIST PRICE	FINISH/ COLOUR	CASE QTY
MOEN II®	TWO-HANDLE LAUNDRY FAUCET				
	<ul style="list-style-type: none"> • application: two hole, four-inch centres • chrome knob handles • overall height: 8.75" • connection size: 1/2" • connection type: IPS • 3/4" hose end • spout swings 	4872	104.25	Chrome	12
	<ul style="list-style-type: none"> • application: two hole, four-inch centres • acrylic handles • overall height: 8.75" • connection size: 1/2" • connection type: IPS • 3/4" hose end • spout swings 	4873	100.25	Chrome	12

Deck Extension kits available on page 370.

Bar/Prep faucets available. See page 44-47.







**WANT TO ADD WATER FILTRATION OR A SOAP DISPENSER
IN THE KITCHEN? SEE page 49-52.**

Modern
Transitional
Traditional

Beverage and Filtering Kitchen Faucets

Having a cold water tap at your kitchen sink is easy and stylish with SIP™ beverage faucets. SIP™ styles feature a high arc rotating spout that provides more convenience at the sink. They are available in coordinating styles for every decorating taste: traditional, transitional or modern.



		MODEL NUMBER	LIST PRICE	FINISH/ COLOUR	CASE QTY	
	SIP™ MODERN ONE-HANDLE BEVERAGE/FILTRATION FAUCET					
	<ul style="list-style-type: none"> • application: one hole • overall height: 10.88" • water usage: 1.5 gpm (5.7 L/min) max. • S5500: filtration sold separately 					
			S5530	303.40	Chrome	3
			S5530SRS ●	457.95	Spot Resist Stainless	3
			S5530BG	457.95	Brushed Gold	3
		NEW! S5530BL	457.95	Matte Black	3	
						
	SIP™ TRANSITIONAL ONE-HANDLE BEVERAGE/FILTRATION FAUCET					
	<ul style="list-style-type: none"> • application: one hole • overall height: 10.88" • water usage: 1.5 gpm (5.7 L/min) max. • S5500: filtration sold separately 					
			S5520	303.40	Chrome	3
			S5520SRS ●	457.95	Spot Resist Stainless	3
			S5520ORB	457.95	Oil Rubbed Bronze	3
		S5520BG	457.95	Brushed Gold	3	
	NEW! S5520BL	457.95	Matte Black	3		
						
	SIP™ TRADITIONAL ONE-HANDLE BEVERAGE/FILTRATION FAUCET					
	<ul style="list-style-type: none"> • application: one hole • overall height: 10.88" • water usage: 1.5 gpm (5.7 L/min) max. • S5500: filtration sold separately 					
			S5510	303.40	Chrome	3
			S5510SRS ●	457.95	Spot Resist Stainless	3
			S5510ORB	457.95	Oil Rubbed Bronze	3
		S5510BG	457.95	Brushed Gold	3	
	NEW! S5510BL	457.95	Matte Black	3		
	NEW! S5510NL	457.95	Polished Nickel	-		
						

Ships Q2





Bar/Prep faucets available. See page 44-47.

WANT TO ADD A SOAP DISPENSER IN THE KITCHEN?
SEE page 51-52.

NOTES

● Spot Resist Stainless Finish **SPOT RESIST**

Beverage and Filtering Faucets

		MODEL NUMBER	LIST PRICE	FINISH/ COLOUR	CASE QTY
FILTRATION SYSTEM					
	<ul style="list-style-type: none"> • water usage: 0.7 gpm (2.7 L/min) max. • filter: included • application: undercounter • system: dry change • batteries: included • use with: S5510, S5520 and S5530 series 	S5500	269.70		6
	<ul style="list-style-type: none"> • includes: replacement battery • use with: F7400, 77200, S5510, S5520, and S5530 series 	9601	62.90		18
	<ul style="list-style-type: none"> • use with: 77100 series 	9001	111.20		6
	<ul style="list-style-type: none"> • use with: PureTouch® Classic series 	601	41.90		12

Bar/Prep faucets available. See page 44-47.





WANT TO ADD A SOAP DISPENSER IN THE KITCHEN?
SEE page 51-52.

Modern
Transitional
Traditional

Soap/Lotion Dispensers

Accessorize your kitchen with stylish soap/lotion dispensers from Moen. They are available in coordinating styles for every decorating taste: traditional, transitional or modern. All come with tops that lift off for easy refill.



		MODEL NUMBER	LIST PRICE	FINISH/ COLOUR	CASE QTY
MODERN SOAP/LOTION DISPENSER					
 <ul style="list-style-type: none"> • overall height: 5.00" • max deck thickness: 3 -1/2" • bottle size: 18 ounce refillable bottle • hole diameter: 1-1/8" hole 		S3947C	160.00	Chrome	6
		S3947SRS ●	201.95	Spot Resist Stainless	6
		S3947BG	201.95	Brushed Gold	6
		NEW! S3947BL	201.95	Matte Black	6
TRANSITIONAL SOAP/LOTION DISPENSER					
 <ul style="list-style-type: none"> • overall height: 5.00" • max deck thickness: 3 -1/2" • bottle size: 18 ounce refillable bottle • hole diameter: 1-1/8" hole 		S3946C	160.00	Chrome	6
		S3946BL	201.95	Matte Black	6
		S3946SRS ●	201.95	Spot Resist Stainless	6
		S3946ORB	201.95	Oil Rubbed Bronze	6
		S3946BG	201.95	Brushed Gold	6
 <ul style="list-style-type: none"> • overall height: 5.00" • max deck thickness: 3 -1/2" • bottle size: 18 ounce refillable bottle • hole diameter: 1-1/8" hole 		S3948C	160.00	Chrome	6
		S3948SRS ●	201.95	Spot Resist Stainless	6
		S3948ORB	201.95	Oil Rubbed Bronze	6
		NEW! S3948BL	201.95	Matte Black	6
TRADITIONAL SOAP/LOTION DISPENSER					
 <ul style="list-style-type: none"> • overall height: 5.00" • max deck thickness: 3 -1/2" • bottle size: 18 ounce refillable bottle • hole diameter: 1-1/8" hole 		S3945C	160.00	Chrome	-
		S3945SRS ●	201.95	Spot Resist Stainless	6
		S3945ORB	201.95	Oil Rubbed Bronze	6
		S3945BG	201.95	Brushed Gold	6
		NEW! S3945BL	201.95	Matte Black	6
		NEW! S3945NL	201.95	Polished Nickel	-

Ships Q2

WANT TO ADD WATER FILTRATION IN THE KITCHEN?
SEE page 49-50.

NOTES

● Spot Resist Stainless Finish **SPOT RESIST**

Soap/Lotion Dispensers, Hose Management

KITCHEN

SOAP/LOTION DISPENSER



- overall height: 3.13"
- max deck thickness: 2 - 1/4"
- bottle size: 18 ounce refillable bottle
- hole diameter: 1-1/8" hole

MODEL NUMBER	LIST PRICE	FINISH/ COLOUR	CASE QTY
3942	111.25	Chrome	6
3942BL	133.90	Matte Black	6
3942W	133.90	Glacier	6
3942SRS ●	133.90	Spot Resist Stainless	6



- overall height: 2.56"
- max deck thickness: 2 - 1/4"
- bottle size: 18 ounce refillable bottle
- hole diameter: 1-1/8" hole

3944	111.25	Chrome	6
3944SRS ●	133.90	Spot Resist Stainless	6
3944ORB	133.90	Oil Rubbed Bronze	6
NEW! 3944BL	133.90	Matte Black	-

PULLOUT/PULLDOWN HOSE MANAGEMENT SYSTEM



- system: helps prevent hose/weight getting caught under sink
- size: can be cut to accommodate different cabinet sizes
- compatible with: Moen kitchen pulldowns and pullout single mount SKUs (excluding Aberdeen®)

159060	23.60		6
---------------	-------	--	---

NOTES

WANT TO ADD WATER FILTRATION IN THE KITCHEN?
SEE page 49-50.

● Spot Resist Stainless Finish **SPOT RESIST**

Bath and Shower



Belfield™ Two-Handle Widespread Bathroom Faucet / T6405
Belfield™ Two-Handle Roman Tub / T9024
Belfield™ Grab Bar / YG6418CH
Belfield™ Hand Towel Bar / YB6486CH
Belfield™ One-Globe Light / YB6461CH

Easily Change Your Style

The Moen® M•PACT® Common Valve system lets you upgrade the style of your faucet or shower as easily as changing a light bulb, saving you time, money and effort.*

Little Effort, Big Difference

With an M•PACT compatible fixture, you can upgrade your bath or shower faucets at any time and never touch the plumbing. All changes can be made above the deck or in front of the wall.

- Untwist your current fixture from the top to remove
- Choose any M•PACT style fixture you like
- Lock right into place

Upgrade Anytime

The system is available in a variety of attractive styles and elegant finishes. Change fixtures at any point while decorating, during construction or years down the road.

What Sets Moen Apart?

Our M•PACT Common Valve System allows the homeowner to completely upgrade the style of their lavatory or shower faucet without replacing any of the faucet plumbing.



The M•PACT Common Valve System is available in the following applications:

- Widespread lav faucets
- Roman tub faucets
- Wall mount lav faucets
- Tub/shower trim



The M•PACT Common Valve System is compatible with Moen bath and shower faucets featuring this logo.

Save Time With The Pro-Fit® Installation System

The Moen three-step Pro-Fit Installation System is the most innovative, simple way to mount bath accessories. The design helps reduce installation time to one-third that of standard bath accessories. Installation is as easy as 1-2-3.

- 1. DRILL IT!** Use the installation mounting template with built-in level.
- 2. SCREW IT!** Screw in the pre-attached fastener.
- 3. CLICK IT!** Press on the post until it locks into place.

It really is that simple! Plus, we've eliminated the set screw. Designed with input from professional installers, the Pro-Fit Installation System was made for faster installation and fewer call backs. And of course, there's the extra assurance of quality that comes with the Moen brand. *Available on select collections.*

The Pro-Fit System eliminates set screws for faster, more durable mounting. There's even a template with a built-in level.



YB8081 Pro-Fit Installation Template



DRILL IT! The innovative template has a built-in level for accurate drilling of pilot holes for both 18" and 24" towel bars or paper holders.



SCREW IT! Single screw mounting system uses pre-attached hollow wall anchor for a fast, solid installation.



CLICK IT! Locking tab clicks to hold the post firmly in place and eliminates the need for a set screw.

Roman Tub Valves

Versatile. Durable. Built To Perform.



Moen® Roman tub valve improvements are designed for faster, more secure mounting on a wider variety of tub decks. Plus, an expanded portfolio of connection options makes installation even easier for installers of all skill levels.

Key Features and Improvements

Supply Connection Options

Moen® also recognizes the increased use of PEX, cold expansion PEX and CPVC supply lines. Plumbers can now order valves designed to work directly with all types of piping—including copper. No other manufacturer offers more options.

Dura-Grip® Mounting System

Robust engineered system where the mounting hardware components work together to prevent the valves and spout from moving after installation, while providing features that work with all types of surfaces (on both fixed and adjustable valves).

Standardized Drill Holes

Only one drill bit (1-1/4") is needed for all spout and handle holes to further speed and simplify installation.

Brass Test Plug

All models include a brass test plug for high-pressure testing after rough-in.

Fixed Roman Tub Valve

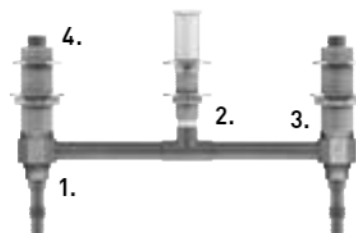

1. Robust, Pre-Soldered Design

Set to standard 10" centres.

2. Dura-Grip® Mounting Hardware

Improved design works with all deck materials including wood, fiberglass, tile and stone.

3. Versatile

Fits tub decks from 1/8" to 1-7/8" thick.

4. M•PACT® Common Valve System Compatible

Accepts all Moen Roman tub trim kits.



All Moen® products are backed by a Limited Lifetime Warranty.

See moen.ca/consumer-support/warranty for complete product warranty information.

Adjustable Roman Tub Valve

1. No-Cut Adjustable Spout Shank

Loosen an expansion nut, extend and lock in place using the supplied metal tool.

2. 3-3/8" Rough-In Deck Thickness

Adapts to decks from 1/8" to 2-3/4" thick—with an additional 1-1/4" of available adjustability to accommodate finish materials.

3. Dura-Grip® Mounting System

Anti-rotation bracket and spout shank assembly provide secure installation to a variety of surfaces both above and below the deck.

4. M•PACT® Common Valve System Compatible

Accepts all Moen® Roman tub trim kits.

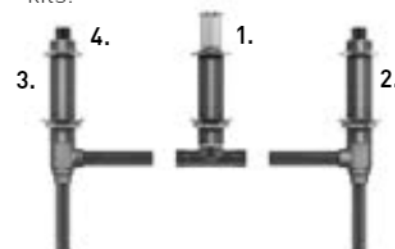

MOEN®

WEYMOUTH® Bathroom Faucets

All Brushed Nickel, Polished Nickel and Brushed Gold faucet components feature the LifeShine® Non-Tarnish Finish.

		MODEL NUMBER	LIST PRICE	FINISH/ CONNECTION	CASE QTY
ONE-HANDLE BATHROOM FAUCET					
 <ul style="list-style-type: none"> • application: one hole • supply line length: flexible • connection size: 3/8" • connection type: compression • drain assembly: push-button • drain assembly type: spring loaded pop-up   DURALAST®		S42107	544.50	Chrome	3
		S42107BN	830.35	Brushed Nickel	3
		S42107NL	830.35	Polished Nickel	3
		S42107ORB	830.35	Oil Rubbed Bronze	3
		NEW! S42107BG	830.35	Brushed Gold	3
		NEW! S42107BL*	830.35	Matte Black	-
TWO-HANDLE WIDESPREAD BATHROOM FAUCET					
 <ul style="list-style-type: none"> • application: three hole • centre dimensions: 8" - 16" centre • drain assembly: metal • drain assembly type: lift rod • valve sold separately   		TS42108	579.45	Chrome	3
		TS42108BN	905.05	Brushed Nickel	3
		TS42108NL	905.05	Polished Nickel	3
		TS42108ORB	905.05	Oil Rubbed Bronze	3
		NEW! TS42108BG	905.05	Brushed Gold	3
		NEW! TS42108BL*	905.05	Matte Black	-
 <ul style="list-style-type: none"> • application: three hole • centre dimensions: 8" - 16" centre • drain assembly: metal • drain assembly type: lift rod • valve sold separately  		TS42114	579.45	Chrome	3
		TS42114BN	905.05	Brushed Nickel	3
		TS42114NL	905.05	Polished Nickel	3
		TS42114ORB	905.05	Oil Rubbed Bronze	3
		NEW! TS42114BG	905.05	Brushed Gold	3
		NEW! TS42114BL*	905.05	Matte Black	-
 <ul style="list-style-type: none"> • application: three hole • centre dimensions: 8" - 16" centre • drain assembly: metal • drain assembly type: lift rod  DURALOCK® DURALAST®		9000	148.70	1/2" IPS	6
 <ul style="list-style-type: none"> • description: handle cap kit 		221672	27.25	Chrome	12
		221672BN	40.20	Brushed Nickel	12
		221672NL	40.20	Polished Nickel	12
		221672ORB	40.20	Oil Rubbed Bronze	-
		NEW! 221672BL*	40.20	Matte Black	-

WEYMOUTH®

HOW TO ORDER A COMPLETE BATHROOM FAUCET

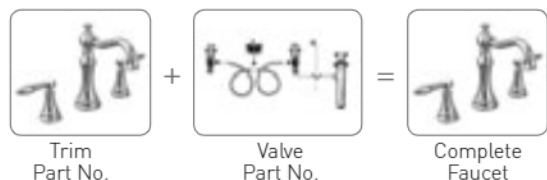











NOTES

-  Moen® **M•PACT®** Common Valve System
- DURALOCK®** Duralock™ Quick Connections
- DURALAST®** Duralast® Cartridge

*Ships Q2

WEYMOUTH® Bathroom Faucets

All Brushed Nickel, Polished Nickel and Brushed Gold faucet components feature the LifeShine® Non-Tarnish Finish.

		MODEL NUMBER	LIST PRICE	FINISH/ CONNECTION	CASE QTY
TWO-HANDLE WALL MOUNT BATHROOM FAUCET					
 <ul style="list-style-type: none"> • application: three hole • centre dimensions: 8" centre • spout reach: 7.84" • drain assembly: 140780 sold separately • valve sold separately   		TS42106	564.75	Chrome	3
		TS42106BN	865.55	Brushed Nickel	3
		TS42106NL	865.55	Polished Nickel	3
		TS42106ORB	865.55	Oil Rubbed Bronze	3
		NEW TS42106BG	865.55	Brushed Gold	3
		NEW TS42106BL*	865.55	Matte Black	-
 <ul style="list-style-type: none"> • application: three hole • centre dimensions: 8" centre • spout reach: 7.84" • drain assembly: 140780 sold separately • valve sold separately  		TS42112	564.75	Chrome	3
		TS42112BN	865.55	Brushed Nickel	3
		TS42112NL	865.55	Polished Nickel	3
		TS42112ORB	865.55	Oil Rubbed Bronze	3
		NEW TS42112BG	865.55	Brushed Gold	3
		NEW TS42112BL*	865.55	Matte Black	-
 <ul style="list-style-type: none"> • application: three hole • centre dimensions: 8" centre • drain assembly: 140780 sold separately • includes: mounting brackets 		9700	219.75	1/2" CC	3
 <ul style="list-style-type: none"> • drain assembly: metal • drain assembly type: spring loaded pop-up 		140780	94.40	Chrome	12
		140780BN	136.05	Brushed Nickel	12
		140780ORB	136.05	Oil Rubbed Bronze	12
		NEW 140780BL	136.05	Matte Black	12
		NEW 140780BG	136.05	Brushed Gold	-
 <ul style="list-style-type: none"> • description: handle cap kit 		221672	27.25	Chrome	12
		221672BN	40.20	Brushed Nickel	12
		221672NL	40.20	Polished Nickel	12
		221672ORB	40.20	Oil Rubbed Bronze	-
		NEW 221672BL*	40.20	Matte Black	-



HOW TO ORDER A COMPLETE BATHROOM FAUCET



NOTES



 Moen® **M•PACT®** Common Valve System

*Ships Q2

WEYMOUTH® Tub Fillers

All Brushed Nickel faucet components feature the LifeShine® Non-Tarnish Finish.

WEYMOUTH®

		MODEL NUMBER	LIST PRICE	FINISH/ CONNECTION	CASE QTY	
FREESTANDING TUB FILLER						
 <ul style="list-style-type: none"> • application: two hole • centre dimensions: 8" centre • connection size: 3/4" • connection type: male • showerhead type: handshower • handshower functions: one-function • handshower flow rate: 1.75 gpm (6.65 L/min) max. 	 DURALAST™	S22105	2,026.30	Chrome	1	
		S22105BN	2,962.30	Brushed Nickel	1	
		S22105ORB	2,962.30	Oil Rubbed Bronze	1	
 <ul style="list-style-type: none"> • application: two hole • centre dimensions: 8" centre • connection size: 3/4" • connection type: male • showerhead type: handshower • handshower functions: one-function • handshower flow rate: 1.75 gpm (6.65 L/min) max. 	 DURALAST™	S22110	2,026.30	Chrome	0	
		S22110BN	2,962.30	Brushed Nickel	0	
		S22110ORB	2,962.30	Oil Rubbed Bronze	1	
 <ul style="list-style-type: none"> • description: floor mount tub filler risers • application: two hole • connection size: 3/4" • connection type: male 		TS25105	837.65	Chrome	3	
		TS25105BN	1,225.20	Brushed Nickel	3	
		TS25105ORB	1,225.20	Oil Rubbed Bronze	3	
 <ul style="list-style-type: none"> • description: double riser floor joist mounting kit • application: two hole • centre dimensions: 8" centre • quarter turn stops: included 		TS50200	504.90	1/2" CC, IPS	2	
 <ul style="list-style-type: none"> • description: handle cap kit 		221672	27.25	Chrome	12	
		221672BN	40.20	Brushed Nickel	12	
		221672ORB	40.20	Oil Rubbed Bronze	-	
 <ul style="list-style-type: none"> • description: diverter button 		221772	46.15	Chrome	12	
		221772BN	55.20	Brushed Nickel	12	

HOW TO ORDER A COMPLETE FLOORMOUNT TUB FILLER FAUCET

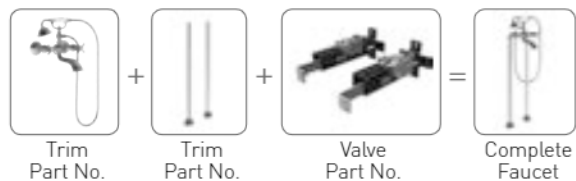

NOTES

 Moen® **M•PACT**® Common Valve System
DURALAST Duralast® Cartridge

WEYMOUTH® Roman Tub

All Brushed Nickel, Polished Nickel and Brushed Gold faucet components feature the LifeShine® Non-Tarnish Finish.

	MODEL NUMBER	LIST PRICE	FINISH/ CONNECTION	CASE QTY
TWO-HANDLE ROMAN TUB				
 <ul style="list-style-type: none"> • application: three hole • spout reach: 8.10" • valve sold separately 	TS22101	708.50	Chrome	3
	TS22101BN	1,088.25	Brushed Nickel	3
	TS22101NL	1,088.25	Polished Nickel	3
	TS22101ORB	1,088.25	Oil Rubbed Bronze	3
	NEW! TS22101BG	1,088.25	Brushed Gold	3
	NEW! TS22101BL*	1,088.25	Matte Black	-
 <ul style="list-style-type: none"> • application: three hole • spout reach: 8.10" • valve sold separately  	TS22103	708.50	Chrome	3
	TS22103BN	1,088.25	Brushed Nickel	3
	TS22103NL	1,088.25	Polished Nickel	3
	TS22103ORB	1,088.25	Oil Rubbed Bronze	3
	NEW! TS22103BG	1,088.25	Brushed Gold	3
	NEW! TS22103BL*	1,088.25	Matte Black	-
 <ul style="list-style-type: none"> • application: three hole • deck thickness: 1/8" to 3-3/8" rough deck • centre dimensions: adjustable • adjustable spout shank: included • test plug: included 	4792	188.00	1/2" CC	6
	4796	179.95	1/2" CC	6
 <ul style="list-style-type: none"> • application: three hole • deck thickness: 1/8" to 1-7/8" deck • centre dimensions: 10" centre • non-adjustable spout shank: included • test plug: included 	4798	179.95	1/2" PEX, Cold Expansion PEX	6
 <ul style="list-style-type: none"> • description: handle cap kit 	221672	27.25	Chrome	12
	221672BN	40.20	Brushed Nickel	12
	221672NL	40.20	Polished Nickel	12
	221672ORB	40.20	Oil Rubbed Bronze	-
	NEW! 221672BL*	40.20	Matte Black	-
 <ul style="list-style-type: none"> • description: high flow thermostatic mixing valve • 1/2" FNPT (3/8" compression adapters) • listed to ASSE Standard 1070 • max. flow rate at 45 psi = 10 gpm • tub application 	104465	223.55	1/2" FNPT	12
 <ul style="list-style-type: none"> • description: PEX transition fittings (2) and clips • adapts standard 1/2" PEX barb to 1/2" PEX cold expansion connections 	140715	11.35	1/2" PEX	200



HOW TO ORDER A COMPLETE ROMAN TUB FAUCET

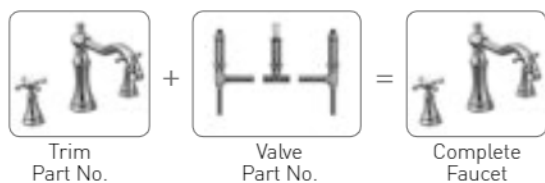











NOTES

 Moen® **M•PACT®** Common Valve System

* Ships Q2

WEYMOUTH® Roman Tub

All Brushed Nickel, Polished Nickel and Brushed Gold faucet components feature the LifeShine® Non-Tarnish Finish.

		MODEL NUMBER	LIST PRICE	FINISH/ CONNECTION	CASE QTY
TWO-HANDLE ROMAN TUB WITH HANDSHOWER					
 <ul style="list-style-type: none"> • application: four hole • showerhead type: handshower • handshower functions: one-function • handshower flow rate: 1.75 gpm (6.65 L/min) max. • spout reach: 8.10" • valve sold separately 		TS21102	1,257.00	Chrome	3
		TS21102BN	2,229.25	Brushed Nickel	3
		TS21102NL	2,229.25	Polished Nickel	3
		TS21102ORB	2,229.25	Oil Rubbed Bronze	3
		NEW TS21102BG	2,229.25	Brushed Gold	3
		NEW TS21102BL*	2,229.25	Matte Black	-
 <ul style="list-style-type: none"> • application: four hole • showerhead type: handshower • handshower functions: one-function • handshower flow rate: 1.75 gpm (6.65 L/min) max. • spout reach: 8.10" • valve sold separately  		TS21104	1,257.00	Chrome	3
		TS21104BN	2,229.25	Brushed Nickel	3
		TS21104NL	2,229.25	Polished Nickel	3
		TS21104ORB	2,229.25	Oil Rubbed Bronze	3
		NEW TS21104BG	2,229.25	Brushed Gold	3
		NEW TS21104BL*	2,229.25	Matte Black	-
 <ul style="list-style-type: none"> • application: four hole • deck thickness: 1/8" to 2-5/8" deck • centre dimensions: 10" centre • non-adjustable spout shank: included • test plug: included 		9796	358.95	1/2" CC	6
		9797	358.95	1/2" CPVC, PEX	6
 <ul style="list-style-type: none"> • description: handle cap kit 		221672	27.25	Chrome	12
		221672BN	40.20	Brushed Nickel	12
		221672NL	40.20	Polished Nickel	12
		221672ORB	40.20	Oil Rubbed Bronze	-
		NEW 221672BL*	40.20	Matte Black	-
 <ul style="list-style-type: none"> • description: high flow thermostatic mixing valve • 1/2" FNPT (3/8" compression adapters) • listed to ASSE Standard 1070 • max. flow rate at 45 psi = 10 gpm • tub application 		104465	223.55	1/2" FNPT	12
 <ul style="list-style-type: none"> • description: PEX transition fittings (2) and clips • adapts standard 1/2" PEX barb to 1/2" PEX cold expansion connections 		140715	11.35	1/2" PEX	200

WEYMOUTH®

HOW TO ORDER A COMPLETE ROMAN TUB FAUCET

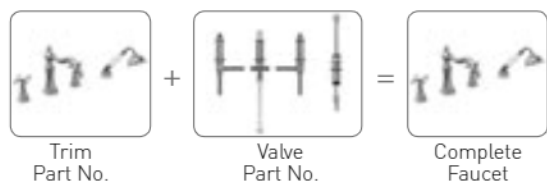







NOTES

 Moen® **M•PACT®** Common Valve System

*Ships Q2

WEYMOUTH® 3/4" Thermostatic Showering

All Brushed Nickel, Polished Nickel and Brushed Gold faucet components feature the LifeShine® Non-Tarnish Finish.

	MODEL NUMBER	LIST PRICE	FINISH/ CONNECTION	CASE QTY
EXACTTEMP® VALVE TRIM				
 <ul style="list-style-type: none"> valve sold separately  	TS32110	373.75	Chrome	3
	TS32110BN	552.25	Brushed Nickel	3
	TS32110NL	552.25	Polished Nickel	3
	TS32110ORB	552.25	Oil Rubbed Bronze	3
	NEW TS32110BG	552.25	Brushed Gold	3
	NEW TS32110BL*	552.25	Matte Black	-
 <ul style="list-style-type: none"> ports: four adjustable temperature limit stop: included check stops: included requires: separate volume control valve 	S3371	626.05	3/4" IPS	6
	 <ul style="list-style-type: none"> description: handle cap kit 			
	221672	27.25	Chrome	12
	221672BN	40.20	Brushed Nickel	12
	221672NL	40.20	Polished Nickel	12
	221672ORB	40.20	Oil Rubbed Bronze	-
	NEW 221672BL*	40.20	Matte Black	-
VOLUME CONTROL VALVE TRIM				
 <ul style="list-style-type: none"> valve sold separately  	TS52104	173.40	Chrome	6
	TS52104BN	244.20	Brushed Nickel	6
	TS52104NL	244.20	Polished Nickel	6
	TS52104ORB	244.20	Oil Rubbed Bronze	6
	NEW TS52104BG	244.20	Brushed Gold	6
	NEW TS52104BL*	244.20	Matte Black	-
 <ul style="list-style-type: none"> description: volume control valve 	S3600	141.15	3/4" IPS	12



HOW TO ORDER A COMPLETE SHOWER FAUCET

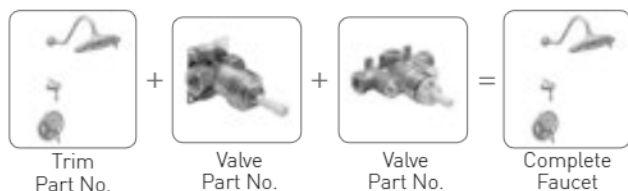



NOTES

 Moen® **M•PACT®** Common Valve System

*Ships Q2

WEYMOUTH® Transfer Valve Shower Spa Components

All Brushed Nickel, Polished Nickel and Brushed Gold faucet components feature the LifeShine® Non-Tarnish Finish.

		MODEL NUMBER	LIST PRICE	FINISH/ CONNECTION	CASE QTY
3 INDEPENDENT FUNCTION TRANSFER VALVE ONLY					
 <ul style="list-style-type: none"> • use with 3362 transfer valve • valve: sold separately  		TS32206	266.80	Chrome	12
		TS32206BN	383.55	Brushed Nickel	12
		TS32206NL	383.55	Polished Nickel	12
		TS32206ORB	383.55	Oil Rubbed Bronze	12
		NEW! TS32206BG	383.55	Brushed Gold	12
		NEW! TS32206BL*	383.55	Matte Black	-
 <ul style="list-style-type: none"> • ports: four • type of function: three independent functions • must be used with: Posi-Temp or Moentrol valve 		3362	215.60	1/2" CC	6
TRANSFER VALVE TRIM					
 <ul style="list-style-type: none"> • valve sold separately  		TS32205	261.25	Chrome	6
		TS32205BN	374.50	Brushed Nickel	6
		TS32205NL	374.50	Polished Nickel	6
		TS32205ORB	374.50	Oil Rubbed Bronze	6
		NEW! TS32205BG	374.50	Brushed Gold	12
		NEW! TS32205BL*	374.50	Matte Black	-
 <ul style="list-style-type: none"> • type of function: two independent one shared • must be used with: Posi-Temp or Moentrol valve 		3372	188.30	1/2" CC	12
 <ul style="list-style-type: none"> • type of function: two discrete • must be used with: Posi-Temp or Moentrol valve 		3375	188.30	1/2" CC	12
 <ul style="list-style-type: none"> • description: finished arrow cap kit 		221673	18.65	Chrome	12
		221673BN	27.50	Brushed Nickel	-
		221673NL	27.50	Polished Nickel	12
		221673ORB	27.50	Oil Rubbed Bronze	-
		NEW! 221673BL*	27.50	Matte Black	-

WEYMOUTH®

HOW TO ORDER A COMPLETE TRANSFER VALVE









NOTES







 Moen® **M•PACT**® Common Valve System

*Ships Q2

WEYMOUTH® Moentrol® Showering

All Brushed Nickel, Polished Nickel and Brushed Gold faucet components feature the LifeShine® Non-Tarnish Finish.

		MODEL NUMBER	LIST PRICE	FINISH/ CONNECTION	CASE QTY
MOENTROL® TUB/SHOWER					
 <ul style="list-style-type: none"> • showerhead type: showerhead sold separately • spout length: 6 3/4" • spout connection type: slip fit • tub spout type: diverter • valve: sold separately 		TS33103NH	522.45	Chrome	3
		TS33103NHBN	745.35	Brushed Nickel	3
		TS33103NHNL	745.35	Polished Nickel	3
		TS33103NHORB	745.35	Oil Rubbed Bronze	3
		NEW! TS33103NHBG	745.35	Brushed Gold	3
		NEW! TS33103NHBL*	745.35	Matte Black	-
 <ul style="list-style-type: none"> • description: pressure balanced valve with volume control • ports: four • adjustable temp limit stop: included • checks: included • includes: volume control 	3510		210.05	1/2" IPS	6
	3520		210.05	1/2" CC	6
 <ul style="list-style-type: none"> • description: pressure balanced valve with volume control • ports: four • adjustable temp limit stop: included • check stops: included • includes: volume control 	3570		232.40	1/2" CC	6

MOENTROL® SHOWER ONLY					
 <ul style="list-style-type: none"> • showerhead type: showerhead sold separately • valve: sold separately 		TS33102NH	438.65	Chrome	3
		TS33102NHBN	632.55	Brushed Nickel	3
		TS33102NHNL	632.55	Polished Nickel	3
		TS33102NHORB	632.55	Oil Rubbed Bronze	3
		NEW! TS33102NHBG	632.55	Brushed Gold	3
		NEW! TS33102NHBL*	632.55	Matte Black	-
 <ul style="list-style-type: none"> • description: pressure balanced valve with volume control • ports: four • adjustable temp limit stop: included • checks: included • includes: volume control 	3510		210.05	1/2" IPS	6
	3520		210.05	1/2" CC	6
 <ul style="list-style-type: none"> • description: pressure balanced valve with volume control • ports: four • adjustable temp limit stop: included • check stops: included • includes: volume control 	3570		232.40	1/2" CC	6

HOW TO ORDER A COMPLETE TUB/SHOWER FAUCET



NOTES







 Moen® **M•PACT®** Common Valve System

*Ships Q2



WEYMOUTH® Moentrol® Showering

All Brushed Nickel, Polished Nickel and Brushed Gold faucet components feature the LifeShine® Non-Tarnish Finish.

		MODEL NUMBER	LIST PRICE	FINISH/ CONNECTION	CASE QTY
MOENTROL® VALVE ONLY					
 <ul style="list-style-type: none"> • valve: sold separately  		TS33101	327.75	Chrome	3
		TS33101BN	491.55	Brushed Nickel	3
		TS33101NL	491.55	Polished Nickel	3
		TS33101ORB	491.55	Oil Rubbed Bronze	3
		NEW! TS33101BG	491.55	Brushed Gold	3
		NEW! TS33101BL*	491.55	Matte Black	-
 <ul style="list-style-type: none"> • description: pressure balanced valve with volume control • ports: four • adjustable temp limit stop: included • checks: included • includes: volume control 		3510	210.05	1/2" IPS	6
		3520	210.05	1/2" CC	6
 <ul style="list-style-type: none"> • description: pressure balanced valve with volume control • ports: four • adjustable temp limit stop: included • check stops: included • includes: volume control 		3570	232.40	1/2" CC	6

WEYMOUTH®

HOW TO ORDER A COMPLETE VALVE













NOTES

 Moen® **M•PACT®** Common Valve System
*Ships Q2

WEYMOUTH® Posi-Temp® Showering

All Brushed Nickel, Polished Nickel and Brushed Gold faucet components feature the LifeShine® Non-Tarnish Finish.

		MODEL NUMBER	LIST PRICE	FINISH/ CONNECTION	CASE QTY		
POSI-TEMP® TUB/SHOWER							
	<ul style="list-style-type: none"> • showerhead functions: two-function • showerhead type: rainshower • showerhead size: 9" diameter spray head • showerhead flow rate: 2.5 gpm (9.5 L/min) max. • spout length: 6 3/4" • spout connection type: slip fit • tub spout type: diverter • valve sold separately 	TS32104 TS32104BN TS32104NL TS32104ORB NEW! TS32104BG NEW! TS32104BL*	650.65 957.85 957.85 957.85 957.85 957.85	Chrome Brushed Nickel Polished Nickel Oil Rubbed Bronze Brushed Gold Matte Black	3 3 3 3 3 -		
							
		<ul style="list-style-type: none"> • showerhead functions: two-function • showerhead type: eco-performance rainshower • showerhead size: 9" diameter spray head • showerhead flow rate: 1.75 gpm (6.65 L/min) max. • spout length: 6 3/4" • spout connection type: slip fit • tub spout type: diverter • valve sold separately 	TS32104EP TS32104EPBN TS32104EPNL TS32104EPORB NEW! TS32104EPBG NEW! TS32104EPBL*	650.65 957.85 957.85 957.85 957.85 957.85	Chrome Brushed Nickel Polished Nickel Oil Rubbed Bronze Brushed Gold Matte Black	3 3 3 3 3 -	
							
			<ul style="list-style-type: none"> • ports: four • adjustable temperature limit stop: included 	2510 2520	152.20 152.20	1/2" IPS 1/2" CC	6 6
							
		<ul style="list-style-type: none"> • ports: four • adjustable temperature limit stop: included • quarter turn stops: included 	2570 2590	194.75 194.75	1/2" CC 1/2" IPS	6 6	
							
	<ul style="list-style-type: none"> • description: handle cap kit 	221672 221672BN 221672NL 221672ORB NEW! 221672BL*	27.25 40.20 40.20 40.20 40.20	Chrome Brushed Nickel Polished Nickel Oil Rubbed Bronze Matte Black	12 12 12 - -		
		<ul style="list-style-type: none"> • description: finished arrow cap kit 	221673 221673BN 221673NL 221673ORB NEW! 221673BL*	18.65 27.50 27.50 27.50 27.50	Chrome Brushed Nickel Polished Nickel Oil Rubbed Bronze Matte Black	12 - 12 - -	



HOW TO ORDER A COMPLETE TUB/SHOWER FAUCET

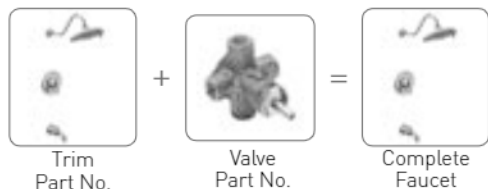













NOTES

-  Moen® **M•PACT®** Common Valve System
-  Immersion® Rainshower
- *Ships Q2

WEYMOUTH® Posi-Temp® Showering

All Brushed Nickel, Polished Nickel and Brushed Gold faucet components feature the LifeShine® Non-Tarnish Finish.

		MODEL NUMBER	LIST PRICE	FINISH/ CONNECTION	CASE QTY
POSI-TEMP® SHOWER ONLY					
 <ul style="list-style-type: none"> • showerhead functions: two-function • showerhead type: rainshower • showerhead size: 9" diameter spray head • showerhead flow rate: 2.5 gpm (9.5 L/min) max. • valve sold separately 		TS32102	540.50	Chrome	3
		TS32102BN	796.45	Brushed Nickel	3
		TS32102NL	796.45	Polished Nickel	3
		TS32102ORB	796.45	Oil Rubbed Bronze	3
		NEW! TS32102BG	796.45	Brushed Gold	3
		NEW! TS32102BL*	796.45	Matte Black	-
  IMMERSION®					
 <ul style="list-style-type: none"> • showerhead functions: two-function • showerhead type: eco-performance rainshower • showerhead size: 9" diameter spray head • showerhead flow rate: 1.75 gpm (6.65 L/min) max. • valve sold separately 		TS32102EP	540.50	Chrome	3
		TS32102EPBN	796.45	Brushed Nickel	3
		TS32102EPNL	796.45	Polished Nickel	3
		TS32102EPORB	796.45	Oil Rubbed Bronze	3
		NEW! TS32102EPBG	796.45	Brushed Gold	3
		NEW! TS32102EPBL*	796.45	Matte Black	-
   IMMERSION®					
		2510	152.20	1/2" IPS	6
		2520	152.20	1/2" CC	6
					
		2570	194.75	1/2" CC	6
		2590	194.75	1/2" IPS	6
					
 <ul style="list-style-type: none"> • description: handle cap kit 		221672	27.25	Chrome	12
		221672BN	40.20	Brushed Nickel	12
		221672NL	40.20	Polished Nickel	12
		221672ORB	40.20	Oil Rubbed Bronze	-
		NEW! 221672BL*	40.20	Matte Black	-
 <ul style="list-style-type: none"> • description: finished arrow cap kit 		221673	18.65	Chrome	12
		221673BN	27.50	Brushed Nickel	-
		221673NL	27.50	Polished Nickel	12
		221673ORB	27.50	Oil Rubbed Bronze	-
		NEW! 221673BL*	27.50	Matte Black	-

WEYMOUTH®

HOW TO ORDER A COMPLETE SHOWER FAUCET











NOTES

 Moen® **M•PACT®** Common Valve System
IMMERSION® Immersion® Rainshower
 *Ships Q2

WEYMOUTH® Posi-Temp® Showering

All Brushed Nickel, Polished Nickel and Brushed Gold faucet components feature the LifeShine® Non-Tarnish Finish.

		MODEL NUMBER	LIST PRICE	FINISH/ CONNECTION	CASE QTY
POSI-TEMP® VALVE TRIM					
 <ul style="list-style-type: none"> valve sold separately  		TS3210	284.95	Chrome	3
		TS3210BN	427.40	Brushed Nickel	3
		TS3210NL	427.40	Polished Nickel	3
		TS3210ORB	427.40	Oil Rubbed Bronze	3
		NEW! TS3210BG	427.40	Brushed Gold	3
		NEW! TS3210BL*	427.40	Matte Black	-
 <ul style="list-style-type: none"> ports: four adjustable temperature limit stop: included 		2510	152.20	1/2" IPS	6
		2520	152.20	1/2" CC	6
 <ul style="list-style-type: none"> ports: four adjustable temperature limit stop: included quarter turn stops: included 		2570	194.75	1/2" CC	6
		2590	194.75	1/2" IPS	6
 <ul style="list-style-type: none"> description: handle cap kit 		221672	27.25	Chrome	12
		221672BN	40.20	Brushed Nickel	12
		221672NL	40.20	Polished Nickel	12
		221672ORB	40.20	Oil Rubbed Bronze	-
		NEW! 221672BL*	40.20	Matte Black	-
 <ul style="list-style-type: none"> description: finished arrow cap kit 		221673	18.65	Chrome	12
		221673BN	27.50	Brushed Nickel	-
		221673NL	27.50	Polished Nickel	12
		221673ORB	27.50	Oil Rubbed Bronze	-
		NEW! 221673BL*	27.50	Matte Black	-



HOW TO ORDER A COMPLETE VALVE

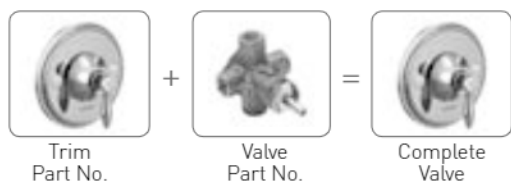

NOTES

 Moen® **M•PACT®** Common Valve System

*Ships Q2

WEYMOUTH® Perfectly Matched Bath Accessories

MODEL NUMBER	LIST PRICE EACH	DESCRIPTION	QTY
Chrome (CH)			
YB8401CH	85.80	Toilet Tank Lever	24
YB8403CH	77.90	Double Robe Hook	24
YB8405CH	15.55	Cabinet Knob	48
YB8407CH	29.20	Drawer Pull	48
 YB8408CH	112.40	Pivoting Paper Holder	6
YB8418CH	126.95	18" Towel Bar	6
YB8424CH	136.90	24" Towel Bar	6
YB8486CH	88.60	Towel Ring	6
Brushed Nickel (BN)			
YB8401BN	97.60	Toilet Tank Lever	24
YB8403BN	89.15	Double Robe Hook	24
YB8405BN	17.65	Cabinet Knob	48
YB8407BN	31.20	Drawer Pull	48
 YB8408BN	123.20	Pivoting Paper Holder	6
YB8418BN	144.25	18" Towel Bar	6
YB8424BN	155.35	24" Towel Bar	6
YB8486BN	101.10	Towel Ring	6
Polished Nickel (NL)			
YB8401NL	107.35	Toilet Tank Lever	24
YB8403NL	98.05	Double Robe Hook	24
YB8405NL	19.45	Cabinet Knob	48
YB8407NL	34.30	Drawer Pull	48
 YB8408NL	135.45	Pivoting Paper Holder	6
YB8418NL	158.60	18" Towel Bar	6
YB8424NL	170.90	24" Towel Bar	6
YB8486NL	111.15	Towel Ring	6
Oil Rubbed Bronze (ORB)			
YB8401ORB	107.35	Toilet Tank Lever	24
YB8403ORB	98.05	Double Robe Hook	24
YB8405ORB	19.45	Cabinet Knob	48
YB8407ORB	34.30	Drawer Pull	48
 YB8408ORB	135.45	Pivoting Paper Holder	6
YB8418ORB	158.60	18" Towel Bar	6
YB8424ORB	170.90	24" Towel Bar	6
YB8486ORB	111.15	Towel Ring	6
Brushed Gold (BG)			
YB8401BG	107.35	Toilet Tank Lever	24
YB8403BG	98.05	Double Robe Hook	24
YB8405BG	19.45	Cabinet Knob	48
YB8407BG	34.30	Drawer Pull	48
 YB8408BG	135.45	Pivoting Paper Holder	6
YB8418BG	158.60	18" Towel Bar	6
YB8424BG	170.90	24" Towel Bar	6
YB8486BG	111.15	Towel Ring	6
Matte Black (BL)			
 YB8401BL	107.35	Toilet Tank Lever	-
 Ships Q2 YB8403BL	98.05	Double Robe Hook	-
YB8405BL	19.45	Cabinet Knob	-
YB8407BL	34.30	Drawer Pull	-
 YB8408BL	135.45	Pivoting Paper Holder	-
YB8418BL	158.60	18" Towel Bar	-
YB8424BL	170.90	24" Towel Bar	-
YB8486BL	111.15	Towel Ring	-

Moen® makes it easy to coordinate the entire style and look of the bathroom. Our Weymouth® bath accessories perfectly match the style and finish of our Weymouth faucets. Total coordination of the bath has never been easier.



YB8401 Toilet Tank Lever



YB8403 Double Robe Hook



YB8405 Cabinet Knob



YB8407 Drawer Pull



YB8408 Pivoting Paper Holder



YB8418 18" Towel Bar



YB8424 24" Towel Bar















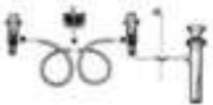

YB8486 Towel Ring

WEYMOUTH®

ARRIS® Bathroom Faucets

All Brushed Nickel faucet components feature the LifeShine® Non-Tarnish Finish.

		MODEL NUMBER	LIST PRICE	FINISH/ CONNECTION	CASE QTY
ONE-HANDLE BATHROOM FAUCET					
 <ul style="list-style-type: none"> • application: one hole • supply line length: flexible • connection size: 3/8" • connection type: compression • drain assembly: push-button • drain assembly type: spring loaded pop-up 		S43001	514.55	Chrome	3
		S43001BN	785.25	Brushed Nickel	3
	  DURALAST®		S43001BL*	785.25	Matte Black
TWO-HANDLE WIDESPREAD BATHROOM FAUCET					
 <ul style="list-style-type: none"> • application: three hole • centre dimensions: 8" - 16" centre • drain assembly: metal • drain assembly type: lift rod • valve sold separately 		TS43002	554.35	Chrome	3
		TS43002BN	836.20	Brushed Nickel	3
	   DURALOCK®		TS43002BL*	836.20	Matte Black
 <ul style="list-style-type: none"> • application: three hole • centre dimensions: 8" - 16" centre • drain assembly: metal • drain assembly type: lift rod 		9000	148.70	1/2" IPS	6
 DURALOCK® DURALAST®					
TWO-HANDLE WALL MOUNT BATHROOM FAUCET					
 <ul style="list-style-type: none"> • application: three hole • centre dimensions: 8" centre • spout reach: 8.00" • drain assembly: 140780 sold separately • valve sold separately 		TS43003	528.35	Chrome	3
		TS43003BN	839.75	Brushed Nickel	3
	  		TS43003BL*	839.75	Matte Black
 <ul style="list-style-type: none"> • application: three hole • centre dimensions: 8" centre • drain assembly: 140780 sold separately • includes: mounting brackets 		9700	219.75	1/2" CC	3
					
 <ul style="list-style-type: none"> • drain assembly: metal • drain assembly type: spring loaded pop-up 		140780	94.40	Chrome	12
		140780BN	136.05	Brushed Nickel	12
		140780BL	136.05	Matte Black	12

HOW TO ORDER A COMPLETE BATHROOM FAUCET

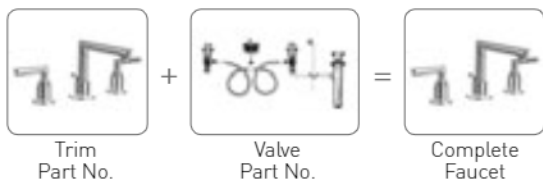





NOTES

-  Moen® **M•PACT®** Common Valve System
- DURALOCK®** Duralock™ Quick Connections
- DURALAST®** Duralast® Cartridge
- *Ships Q2



ARRIS® Tub Fillers

All Brushed Nickel faucet components feature the LifeShine® Non-Tarnish Finish.

		MODEL NUMBER	LIST PRICE	FINISH/ CONNECTION	CASE QTY
FREESTANDING TUB FILLER					
	<ul style="list-style-type: none"> • application: one hole • showerhead type: handshower • handshower functions: one-function • handshower flow rate: 1.75 gpm (6.65 L/min) max. • valve sold separately 	S93005	2,070.60	Chrome	1
		S93005BN	2,950.50	Brushed Nickel	0
					
	<ul style="list-style-type: none"> • description: floor joist mounting kit • application: one hole • quarter turn stops included 	TS50100	336.65	1/2" CC, IPS	2
					

ARRIS®

HOW TO ORDER A COMPLETE FLOORMOUNT TUB FILLER













NOTES

 Moen® **M•PACT**® Common Valve System

ARRIS® Roman Tub

All Brushed Nickel faucet components feature the LifeShine® Non-Tarnish Finish.

	MODEL NUMBER	LIST PRICE	FINISH/ CONNECTION	CASE QTY	
TWO-HANDLE ROMAN TUB					
 <ul style="list-style-type: none"> • application: three hole • spout reach: 8.08" • valve sold separately  	TS93003 TS93003BN  TS93003BL*	690.95 1,041.50 1,041.50	Chrome Brushed Nickel Matte Black	3 3 -	
	 <ul style="list-style-type: none"> • application: three hole • deck thickness: 1/8" to 3-3/8" rough deck • centre dimensions: adjustable • adjustable spout shank: included • test plug: included 	4792	188.00	1/2" CC	6
	 <ul style="list-style-type: none"> • application: three hole • deck thickness: 1/8" to 1-7/8" deck • centre dimensions: 10" centre • non-adjustable spout shank: included • test plug: included 	4796 4798	179.95 179.95	1/2" CC 1/2" PEX, Cold Expansion PEX	6 6
 <ul style="list-style-type: none"> • description: high flow thermostatic mixing valve • 1/2" FNPT (3/8" compression adapters) • listed to ASSE Standard 1070 • max. flow rate at 45 psi = 10 gpm • tub application 	104465	223.55	1/2" FNPT	12	
 <ul style="list-style-type: none"> • description: PEX transition fittings (2) and clips • adapts standard 1/2" PEX barb to 1/2" PEX cold expansion connections 	140715	11.35	1/2" PEX	200	



HOW TO ORDER A COMPLETE ROMAN TUB FAUCET

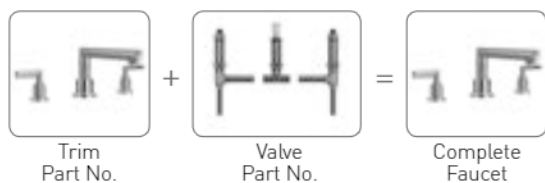







NOTES

 Moen® **M•PACT®** Common Valve System

*Ships Q2

ARRIS® Roman Tubs

All Brushed Nickel faucet components feature the LifeShine® Non-Tarnish Finish.

		MODEL NUMBER	LIST PRICE	FINISH/ CONNECTION	CASE QTY
TWO-HANDLE ROMAN TUB WITH HANDSHOWER					
 <ul style="list-style-type: none"> • application: four hole • showerhead type: handshower • handshower functions: one-function • handshower flow rate: 1.75 gpm (6.65 L/min) max. • spout reach: 8.08" • valve sold separately  		TS93004	1,157.80	Chrome	3
		TS93004BN	2,035.60	Brushed Nickel	3
		TS93004BL*	2,035.60	Matte Black	-
 <ul style="list-style-type: none"> • application: four hole • deck thickness: 1/8" to 2-5/8" deck • centre dimensions: 10" centre • non-adjustable spout shank: included • test plug: included 		9796	358.95	1/2" CC	6
		9797	358.95	1/2" CPVC, PEX	6
 <ul style="list-style-type: none"> • description: high flow thermostatic mixing valve • 1/2" FNPT (3/8" compression adapters) • listed to ASSE Standard 1070 • max. flow rate at 45 psi = 10 gpm • tub application 		104465	223.55	1/2" FNPT	12
 <ul style="list-style-type: none"> • description: PEX transition fittings (2) and clips • adapts standard 1/2" PEX barb to 1/2" PEX cold expansion connections 		140715	11.35	1/2" PEX	200

ARRIS®

HOW TO ORDER A COMPLETE ROMAN TUB FAUCET

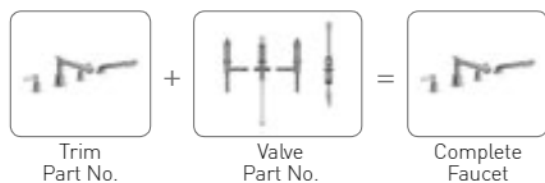











NOTES

 Moen® **M•PACT®** Common Valve System

*Ships Q2

ARRIS® 3/4" Thermostatic Showering

All Brushed Nickel faucet components feature the LifeShine® Non-Tarnish Finish.

		MODEL NUMBER	LIST PRICE	FINISH/ CONNECTION	CASE QTY
EXACTTEMP® VALVE TRIM					
 <ul style="list-style-type: none"> valve sold separately  		TS33002	373.75	Chrome	3
		TS33002BN	552.25	Brushed Nickel	3
		NEW! TS33002BL*	552.25	Matte Black	-
 <ul style="list-style-type: none"> ports: four adjustable temperature limit stop: included check stops: included requires: separate volume control valve 		S3371	626.05	3/4" IPS	6
	VOLUME CONTROL VALVE TRIM				
 <ul style="list-style-type: none"> valve sold separately  		TS33003	173.40	Chrome	6
		TS33003BN	244.20	Brushed Nickel	6
		NEW! TS33003BL*	244.20	Matte Black	-
 <ul style="list-style-type: none"> description: volume control valve 		S3600	141.15	3/4" IPS	12



HOW TO ORDER A COMPLETE SHOWER FAUCET

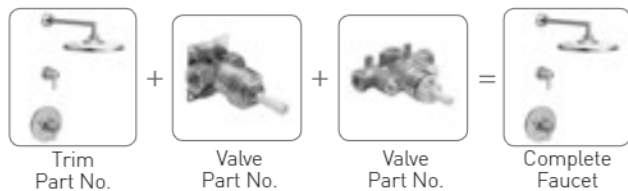













NOTES

 Moen® **M•PACT®** Common Valve System

*Ships Q2

ARRIS® Transfer Valve Shower Spa Components

All Brushed Nickel faucet components feature the LifeShine® Non-Tarnish Finish.

		MODEL NUMBER	LIST PRICE	FINISH/ CONNECTION	CASE QTY
3 INDEPENDENT FUNCTION TRANSFER VALVE ONLY					
 <ul style="list-style-type: none"> • use with 3362 transfer valve • valve: sold separately  		TS23006	266.80	Chrome	12
		TS23006BN	383.55	Brushed Nickel	12
		NEW! TS23006BL*	383.55	Matte Black	-
3362					
 <ul style="list-style-type: none"> • ports: four • type of function: three independent functions • must be used with: Posi-Temp or Moentrol valve 			215.60	1/2" CC	6
TRANSFER VALVE TRIM					
 <ul style="list-style-type: none"> • valve sold separately  		TS23005	261.25	Chrome	6
		TS23005BN	374.50	Brushed Nickel	6
		NEW! TS23005BL*	374.50	Matte Black	-
3372					
 <ul style="list-style-type: none"> • type of function: two independent one shared • must be used with: Posi-Temp or Moentrol valve 			188.30	1/2" CC	12
3375					
 <ul style="list-style-type: none"> • type of function: two discrete • must be used with: Posi-Temp or Moentrol valve 			188.30	1/2" CC	12

ARRIS®

HOW TO ORDER A COMPLETE TRANSFER VALVE









NOTES

 Moen® **M•PACT®** Common Valve System
*Ships Q2

ARRIS® Moentrol® Showering

All Brushed Nickel faucet components feature the LifeShine® Non-Tarnish Finish.

		MODEL NUMBER	LIST PRICE	FINISH/ CONNECTION	CASE QTY
MOENTROL® TUB/SHOWER					
 <ul style="list-style-type: none"> • showerhead type: showerhead sold separately • spout length: 6 3/4" • spout connection type: slip fit • tub spout type: diverter • valve: sold separately 		TS32003NH	522.45	Chrome	3
		TS32003NHBN	745.35	Brushed Nickel	3
		NEW! TS32003NHBL*	745.35	Matte Black	-
 <ul style="list-style-type: none"> • description: pressure balanced valve with volume control • ports: four • adjustable temp limit stop: included • checks: included • includes: volume control 		3510	210.05	1/2" IPS	6
		3520	210.05	1/2" CC	6
 <ul style="list-style-type: none"> • description: pressure balanced valve with volume control • ports: four • adjustable temp limit stop: included • check stops: included • includes: volume control 		3570	232.40	1/2" CC	6

MOENTROL® SHOWER ONLY					
 <ul style="list-style-type: none"> • showerhead type: showerhead sold separately • valve: sold separately 		TS32002NH	438.65	Chrome	3
		TS32002NHBN	632.55	Brushed Nickel	3
		NEW! TS32002NHBL*	632.55	Matte Black	-
 <ul style="list-style-type: none"> • description: pressure balanced valve with volume control • ports: four • adjustable temp limit stop: included • checks: included • includes: volume control 		3510	210.05	1/2" IPS	6
		3520	210.05	1/2" CC	6
 <ul style="list-style-type: none"> • description: pressure balanced valve with volume control • ports: four • adjustable temp limit stop: included • check stops: included • includes: volume control 		3570	232.40	1/2" CC	6

HOW TO ORDER A COMPLETE TUB/SHOWER FAUCET

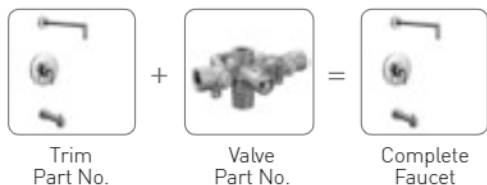







NOTES

 Moen® **M•PACT®** Common Valve System
 *Ships Q2



ARRIS® Moentrol® Showering

All Brushed Nickel faucet components feature the LifeShine® Non-Tarnish Finish.

		MODEL NUMBER	LIST PRICE	FINISH/ CONNECTION	CASE QTY
MOENTROL® VALVE ONLY					
 <ul style="list-style-type: none"> valve: sold separately  		TS32001	327.75	Chrome	3
		TS32001BN	491.55	Brushed Nickel	3
		TS32001BL*	491.55	Matte Black	-
  <ul style="list-style-type: none"> description: pressure balanced valve with volume control ports: four adjustable temp limit stop: included checks: included includes: volume control 		3510	210.05	1/2" IPS	6
		3520	210.05	1/2" CC	6
  <ul style="list-style-type: none"> description: pressure balanced valve with volume control ports: four adjustable temp limit stop: included check stops: included includes: volume control 		3570	232.40	1/2" CC	6

ARRIS®

HOW TO ORDER A COMPLETE VALVE











NOTES

 Moen® **M•PACT®** Common Valve System
*Ships Q2

ARRIS® Posi-Temp® Showering

All Brushed Nickel faucet components feature the LifeShine® Non-Tarnish Finish.

		MODEL NUMBER	LIST PRICE	FINISH/ CONNECTION	CASE QTY
POSI-TEMP® TUB/SHOWER					
	<ul style="list-style-type: none"> • showerhead functions: one-function • showerhead type: rainshower • showerhead size: 10" diameter spray head • showerhead flow rate: 2.5 gpm [9.5 L/min] max. • spout length: 6 3/4" • spout connection type: slip fit • tub spout type: diverter • valve sold separately 	TS22003	650.65	Chrome	3
		TS22003BN	957.85	Brushed Nickel	3
		NEW! TS22003BL*	957.85	Matte Black	-
					
	<ul style="list-style-type: none"> • showerhead functions: one-function • showerhead type: eco-performance rainshower • showerhead size: 10" diameter spray head • showerhead flow rate: 1.75 gpm [6.65 L/min] max. • spout length: 6 3/4" • spout connection type: slip fit • tub spout type: diverter • valve sold separately 	TS22003EP	650.65	Chrome	3
		TS22003EPBN	957.85	Brushed Nickel	3
		NEW! TS22003EPBL*	957.85	Matte Black	-
					
	<ul style="list-style-type: none"> • ports: four • adjustable temperature limit stop: included 	2510	152.20	1/2" IPS	6
		2520	152.20	1/2" CC	6
					
	<ul style="list-style-type: none"> • ports: four • adjustable temperature limit stop: included • quarter turn stops: included 	2570	194.75	1/2" CC	6
		2590	194.75	1/2" IPS	6
					



HOW TO ORDER A COMPLETE TUB/SHOWER FAUCET

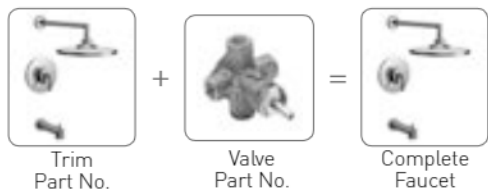











NOTES

- Moën® **M•PACT**® Common Valve System
- IMMERISION® Immersion® Rainshower
- *Ships Q2

ARRIS® Posi-Temp® Showering

All Brushed Nickel faucet components feature the LifeShine® Non-Tarnish Finish.



		MODEL NUMBER	LIST PRICE	FINISH/ CONNECTION	CASE QTY
POSI-TEMP® SHOWER ONLY					
	<ul style="list-style-type: none"> • showerhead functions: one-function • showerhead type: rainshower • showerhead size: 10" diameter spray head • showerhead flow rate: 2.5 gpm (9.5 L/min) max. • valve sold separately 	TS22002	540.50	Chrome	3
		TS22002BN	796.45	Brushed Nickel	3
		TS22002BL*	796.45	Matte Black	-
	  IMMERSION				
	<ul style="list-style-type: none"> • showerhead functions: one-function • showerhead type: eco-performance rainshower • showerhead size: 10" diameter spray head • showerhead flow rate: 1.75 gpm (6.65 L/min) max. • valve sold separately 	TS22002EP	540.50	Chrome	3
		TS22002EPBN	796.45	Brushed Nickel	3
		TS22002EPBL*	796.45	Matte Black	-
	   IMMERSION				
	<ul style="list-style-type: none"> • ports: four • adjustable temperature limit stop: included 	2510	152.20	1/2" IPS	6
		2520	152.20	1/2" CC	6
					
	<ul style="list-style-type: none"> • ports: four • adjustable temperature limit stop: included • quarter turn stops: included 	2570	194.75	1/2" CC	6
		2590	194.75	1/2" IPS	6
					

ARRIS®

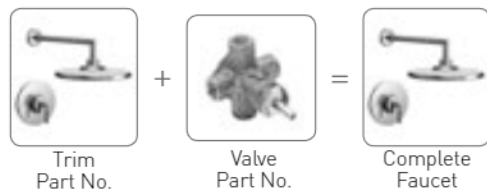
HOW TO ORDER A COMPLETE SHOWER FAUCET









NOTES

-  Moen® **M•PACT**® Common Valve System
-  Immersion® Rainshower
- *Ships Q2

ARRIS® Posi-Temp® Showering

All Brushed Nickel faucet components feature the LifeShine® Non-Tarnish Finish.

		MODEL NUMBER	LIST PRICE	FINISH/ CONNECTION	CASE QTY
POSI-TEMP® VALVE TRIM					
 <ul style="list-style-type: none"> valve sold separately  		TS22001	284.95	Chrome	3
		TS22001BN	427.40	Brushed Nickel	3
		TS22001BL*	427.40	Matte Black	-
 <ul style="list-style-type: none"> ports: four adjustable temperature limit stop: included 		2510	152.20	1/2" IPS	6
		2520	152.20	1/2" CC	6
 <ul style="list-style-type: none"> ports: four adjustable temperature limit stop: included quarter turn stops: included 		2570	194.75	1/2" CC	6
		2590	194.75	1/2" IPS	6



HOW TO ORDER A COMPLETE VALVE



NOTES

 Moen® **M•PACT®** Common Valve System

*Ships Q2

ARRIS® Perfectly Matched Bath Accessories

MODEL NUMBER	LIST PRICE EACH	DESCRIPTION	QTY	
Chrome (CH)				
YB0801CH	81.80	Toilet Tank Lever	24	
YB0803CH	78.65	Double Robe Hook	24	
 YB0808CH	111.85	Paper Holder	6	
YB0818CH	129.40	18" Towel Bar	6	
YB0824CH	139.65	24" Towel Bar	6	
YB0886CH	90.30	Towel Ring	6	
YB0892CH	225.15	Wallmount 5X Magnifying Mirror	3	
Brushed Nickel (BN)				
YB0801BN	99.40	Toilet Tank Lever	24	
YB0803BN	86.20	Double Robe Hook	24	
 YB0808BN	123.00	Paper Holder	6	
YB0818BN	142.25	18" Towel Bar	6	
YB0824BN	153.80	24" Towel Bar	6	
YB0886BN	99.30	Towel Ring	6	
YB0892BN	257.45	Wallmount 5X Magnifying Mirror	3	
Matte Black (BL)				
 Ships Q2	YB0801BL	99.40	Toilet Tank Lever	-
YB0803BL	86.20	Double Robe Hook	-	
 YB0808BL	123.00	Paper Holder	-	
YB0818BL	142.25	18" Towel Bar	-	
YB0824BL	153.80	24" Towel Bar	-	
YB0886BL	99.30	Towel Ring	-	
YB0892BL	257.45	Wallmount 5X Magnifying Mirror	-	

GRAB BARS

PERFECTLY MATCHED to Moen® Arris® faucets and bath accessories. ADA-compliant.



SecureMount™ Grab Bars are manufactured with an innovative flange design that makes it easy to connect to the stud at multiple points.

To install grab bars securely without studs, use SecureMount™ Anchors. Sold separately.

MODEL NUMBER	LIST PRICE EACH	DESCRIPTION	QTY	
1-1/4" • Chrome (CH)				
YG0812CH	135.45	12" Grab Bar	6	
YG0818CH	141.55	18" Grab Bar	6	
YG0824CH	147.80	24" Grab Bar	6	
YG0836CH	168.35	36" Grab Bar	6	
1-1/4" • Brushed Nickel (BN)				
YG0812BN	146.35	12" Grab Bar	6	
YG0818BN	153.50	18" Grab Bar	6	
YG0824BN	165.65	24" Grab Bar	6	
YG0836BN	186.50	36" Grab Bar	6	
1-1/4" • Matte Black (BL)				
 Ships Q2	YG0812BL	146.35	12" Grab Bar	-
YG0818BL	153.50	18" Grab Bar	-	
YG0824BL	165.65	24" Grab Bar	-	
YG0836BL	186.50	36" Grab Bar	-	
SecureMount Anchors™				
SMA1005CH	21.20	SecureMount Anchors™ (1 pc Chrome Mounting Plates)	3	
SMA1000OWB	48.80	SecureMount Anchors™ (2 pc Old World Bronze Mounting Plates)	24	

Moen® makes it easy to coordinate the entire style and look of the bathroom. Our Arris® bath accessories perfectly match the style and finish of our Arris faucets. Total coordination of the bath has never been easier.



YB0801 Toilet Tank Lever



YB0803 Double Robe Hook



YB0808 Pivoting Paper Holder



YB0818 18" Towel Bar



YB0824 24" Towel Bar



YB0886 Towel Ring



YB0892 Wallmount 5X Magnifying Mirror













YG0824 1-1/4" Diameter x 24" length (Concealed Screw)



Complies with Americans with Disabilities Act (ADA) specifications. SecureMount™ Grab Bars are tested to withstand 500 lb. pull when securely installed per instructions.

WATERHILL® Bathroom Faucets

All Brushed Nickel and Polished Nickel faucet components feature the LifeShine® Non-Tarnish Finish.

	MODEL NUMBER	LIST PRICE	FINISH/ CONNECTION	CASE QTY
ONE-HANDLE BATHROOM FAUCET				
 <ul style="list-style-type: none"> • application: one or three hole • supply line length: flexible • connection size: 3/8" • connection type: compression • deck plate: included • drain assembly: metal • drain assembly type: lift rod   DURALAST®	S411	485.15	Chrome	3
	S411BN	741.20	Brushed Nickel	3
	S411ORB	741.20	Oil Rubbed Bronze	3
 <ul style="list-style-type: none"> • description: vessel extension kit • includes: 3" extensions • includes: parts to convert to grid drain 	S115	141.10	Chrome	6
	S115BN	228.90	Brushed Nickel	6
	S115ORB	228.90	Oil Rubbed Bronze	6
TWO-HANDLE WIDESPREAD BATHROOM FAUCET				
 <ul style="list-style-type: none"> • application: three hole • centre dimensions: 8" - 16" centre • drain assembly: metal • drain assembly type: lift rod • valve sold separately   	TS418	540.60	Chrome	3
	TS418BN	836.20	Brushed Nickel	3
	TS418ORB	836.20	Oil Rubbed Bronze	3
 <ul style="list-style-type: none"> • application: three hole • centre dimensions: 8" - 16" centre • drain assembly: metal • drain assembly type: lift rod  DURALOCK® DURALAST®	9000	148.70	1/2" IPS	6



HOW TO ORDER A COMPLETE BATHROOM FAUCET

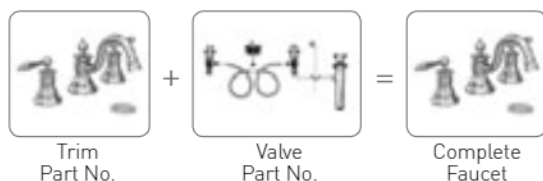









NOTES

-  Moen® **M•PACT®** Common Valve System
- DURALOCK®** Duralock™ Quick Connections
- DURALAST®** Duralast® Cartridge

WATERHILL® Roman Tubs

All Brushed Nickel and Polished Nickel faucet components feature the LifeShine® Non-Tarnish Finish.





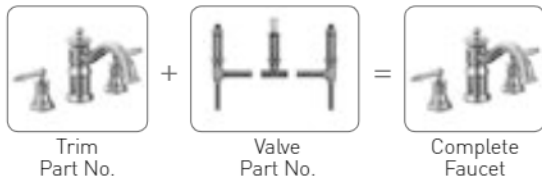



		MODEL NUMBER	LIST PRICE	FINISH/ CONNECTION	CASE QTY
TWO-HANDLE ROMAN TUB FAUCET					
 <ul style="list-style-type: none"> • application: three hole • spout reach: 8.86" • valve sold separately  		TS214	690.95	Chrome	3
		TS214BN	1,041.50	Brushed Nickel	3
		TS214ORB	1,041.50	Oil Rubbed Bronze	3
 <ul style="list-style-type: none"> • application: three hole • deck thickness: 1/8" to 3-3/8" rough deck • centre dimensions: adjustable • adjustable spout shank: included • test plug: included 		4792	188.00	1/2" CC	6
		4796	179.95	1/2" CC	6
 <ul style="list-style-type: none"> • application: three hole • deck thickness: 1/8" to 1-7/8" deck • centre dimensions: 10" centre • non-adjustable spout shank: included • test plug: included 		4798	179.95	1/2" PEX, Cold Expansion PEX	6
		104465	223.55	1/2" FNPT	12
 <ul style="list-style-type: none"> • description: high flow thermostatic mixing valve • 1/2" FNPT (3/8" compression adapters) • listed to ASSE Standard 1070 • max. flow rate at 45 psi = 10 gpm • tub application 		140715	11.35	1/2" PEX	200
 <ul style="list-style-type: none"> • description: PEX transition fittings (2) and clips • adapts standard 1/2" PEX barb to 1/2" PEX cold expansion connections 					

WATERHILL®

HOW TO ORDER A COMPLETE ROMAN TUB FAUCET**NOTES**
 Moen® **M•PACT®** Common Valve System

WATERHILL® 3/4" Thermostatic Showering

All Brushed Nickel and Polished Nickel faucet components feature the LifeShine® Non-Tarnish Finish.

		MODEL NUMBER	LIST PRICE	FINISH/ CONNECTION	CASE QTY
EXACTTEMP® VALVE TRIM					
 <ul style="list-style-type: none"> valve sold separately 		TS3110	336.30	Chrome	3
		TS3110BN	524.75	Brushed Nickel	3
		TS3110ORB	524.75	Oil Rubbed Bronze	3
					
 <ul style="list-style-type: none"> ports: four adjustable temperature limit stop: included check stops: included requires: separate volume control valve 		S3371	626.05	3/4" IPS	6
					
VOLUME CONTROL VALVE TRIM					
 <ul style="list-style-type: none"> valve sold separately 		TS514	160.90	Chrome	6
		TS514BN	231.95	Brushed Nickel	6
		TS514ORB	231.95	Oil Rubbed Bronze	6
					
 <ul style="list-style-type: none"> description: volume control valve 		S3600	141.15	3/4" IPS	12
					



HOW TO ORDER A COMPLETE SHOWER FAUCET

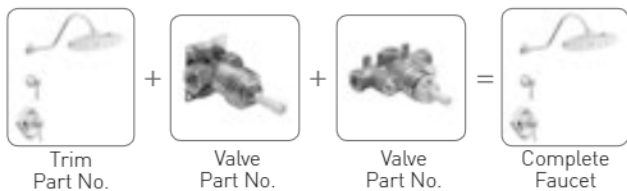







NOTES

Moën® **M•PACT**® Common Valve System

WATERHILL® Transfer Valve Shower Spa Components

All Brushed Nickel and Polished Nickel faucet components feature the LifeShine® Non-Tarnish Finish.

	MODEL NUMBER	LIST PRICE	FINISH/ CONNECTION	CASE QTY
TRANSFER VALVE TRIM				
 <ul style="list-style-type: none"> valve sold separately  	TS325	236.85	Chrome	6
	TS325BN	348.55	Brushed Nickel	6
	TS325ORB	348.55	Oil Rubbed Bronze	6
 <ul style="list-style-type: none"> type of function: two independent one shared must be used with: Posi-Temp or Moentrol valve 	3372	188.30	1/2" CC	12
 <ul style="list-style-type: none"> type of function: two discrete must be used with: Posi-Temp or Moentrol valve 	3375	188.30	1/2" CC	12

WATERHILL®

HOW TO ORDER A COMPLETE TRANSFER VALVE















NOTES

 Moen® **M•PACT®** Common Valve System

WATERHILL® Posi-Temp® Showering

All Brushed Nickel and Polished Nickel faucet components feature the LifeShine® Non-Tarnish Finish.

		MODEL NUMBER	LIST PRICE	FINISH/ CONNECTION	CASE QTY
POSI-TEMP® TUB/SHOWER					
	<ul style="list-style-type: none"> • showerhead functions: one-function • showerhead type: rainshower • showerhead size: 10" diameter spray head • showerhead flow rate: 2.5 gpm (9.5 L/min) max. • spout length: 6 3/4" • spout connection type: slip fit • tub spout type: diverter • valve sold separately 	TS314	581.95	Chrome	3
		TS314BN	766.85	Brushed Nickel	3
		TS314ORB	766.85	Oil Rubbed Bronze	3
					
	<ul style="list-style-type: none"> • ports: four • adjustable temperature limit stop: included 	2510	152.20	1/2" IPS	6
		2520	152.20	1/2" CC	6
					
	<ul style="list-style-type: none"> • ports: four • adjustable temperature limit stop: included • quarter turn stops included 	2570	194.75	1/2" CC	6
		2590	194.75	1/2" IPS	6
					

POSI-TEMP® SHOWER ONLY					
	<ul style="list-style-type: none"> • showerhead functions: one-function • showerhead type: rainshower • showerhead size: 10" diameter spray head • showerhead flow rate: 2.5 gpm (9.5 L/min) max. • valve sold separately 	TS312	485.15	Chrome	3
		TS312BN	715.60	Brushed Nickel	3
		TS312ORB	715.60	Oil Rubbed Bronze	3
					
	<ul style="list-style-type: none"> • ports: four • adjustable temperature limit stop: included 	2510	152.20	1/2" IPS	6
		2520	152.20	1/2" CC	6
					
	<ul style="list-style-type: none"> • ports: four • adjustable temperature limit stop: included • quarter turn stops: included 	2570	194.75	1/2" CC	6
		2590	194.75	1/2" IPS	6
					

HOW TO ORDER A COMPLETE SHOWERING FAUCET

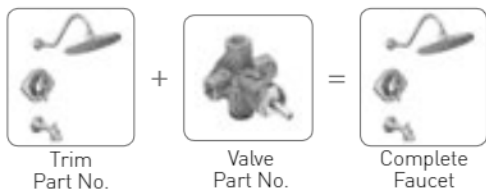







NOTES

-  Moen® **M•PACT®** Common Valve System
-  Immersion® Rainshower

WATERHILL®

WATERHILL® Posi-Temp® Showering

All Brushed Nickel and Polished Nickel faucet components feature the LifeShine® Non-Tarnish Finish.

		MODEL NUMBER	LIST PRICE	FINISH/ CONNECTION	CASE QTY
POSI-TEMP® VALVE TRIM					
 <ul style="list-style-type: none"> valve sold separately  		TS310	270.75	Chrome	3
		TS310BN	406.15	Brushed Nickel	3
		TS310ORB	406.15	Oil Rubbed Bronze	3
 <ul style="list-style-type: none"> ports: four adjustable temperature limit stop: included 		2510	152.20	1/2" IPS	6
		2520	152.20	1/2" CC	6
 <ul style="list-style-type: none"> ports: four adjustable temperature limit stop: included quarter turn stops: included 		2570	194.75	1/2" CC	6
		2590	194.75	1/2" IPS	6

WATERHILL®

HOW TO ORDER A COMPLETE VALVE



NOTES

 Moen® **M•PACT®** Common Valve System

WATERHILL® Perfectly Matched Bath Accessories

Moen® makes it easy to coordinate the entire style and look of the bathroom. Our Waterhill® bath accessories perfectly match the style and finish of our Waterhill faucets. Total coordination of the bath has never been easier.

MODEL NUMBER	LIST PRICE EACH	DESCRIPTION	QTY
Chrome (CH)			
YB9801CH	76.75	Toilet Tank Lever	3
YB9803CH	75.40	Double Robe Hook with Swivel Top	6
YB9805CH	13.90	Cabinet Knob	48
YB9807CH	25.85	Drawer Pull	48
 YB9808CH	107.35	Pivoting Paper Holder	6
YB9818CH	123.40	18" Towel Bar	6
YB9824CH	133.55	24" Towel Bar	6
YB9886CH	91.25	Towel Ring	6
Brushed Nickel (BN)			
YB9801BN	93.65	Toilet Tank Lever	-
YB9803BN	86.85	Double Robe Hook with Swivel Top	24
YB9805BN	15.75	Cabinet Knob	48
YB9807BN	27.70	Drawer Pull	48
 YB9808BN	123.40	Pivoting Paper Holder	6
YB9818BN	142.80	18" Towel Bar	6
YB9824BN	154.10	24" Towel Bar	6
YB9886BN	104.45	Towel Ring	6
Oil Rubbed Bronze (ORB)			
YB9801ORB	93.65	Toilet Tank Lever	-
YB9803ORB	86.85	Double Robe Hook with Swivel Top	24
YB9805ORB	17.25	Cabinet Knob	48
YB9807ORB	30.55	Drawer Pull	48
 YB9808ORB	123.40	Pivoting Paper Holder	6
YB9818ORB	142.80	18" Towel Bar	6
YB9824ORB	154.10	24" Towel Bar	6
YB9886ORB	104.45	Towel Ring	6



YB9801
Toilet Tank Lever



YB9803
Double Robe Hook with Swivel Top



YB9805
Cabinet Knob



YB9807
Drawer Pull



YB9808 
Pivoting Paper Holder



YB9818
18" Towel Bar



YB9824
24" Towel Bar



YB9886
Towel Ring





WATERHILL®

LIGHTING











MODEL NUMBER	LIST PRICE EACH	DESCRIPTION	QTY
Chrome (CH)			
YB9861CH	195.10	One-Globe Light	2
YB9862CH	272.00	Two-Globe Light	2
YB9863CH	298.20	Three-Globe Light	2
YB9864CH	408.05	Four-Globe Light	2
Brushed Nickel (BN)			
YB9861BN	243.20	One-Globe Light	2
YB9862BN	339.40	Two-Globe Light	2
YB9863BN	373.65	Three-Globe Light	2
YB9864BN	509.70	Four-Globe Light	2
Oil Rubbed Bronze (ORB)			
YB9861ORB	243.20	One-Globe Light	2
YB9862ORB	339.40	Two-Globe Light	2
YB9863ORB	373.65	Three-Globe Light	2
YB9864ORB	509.70	Four-Globe Light	2
Replacement Globe			
YB9869	35.80	Replacement Globe Service Kit	-

YB9861
One-Globe LightYB9862
Two-Globe LightYB9863
Three-Globe LightYB9869
Replacement Globe
Service KitYB9864
Four-Globe Light

Bulbs not included.

90™ Bathroom Faucets

All Brushed Nickel faucet components feature the LifeShine® Non-Tarnish Finish.

		MODEL NUMBER	LIST PRICE	FINISH/ CONNECTION	CASE QTY
ONE-HANDLE BATHROOM FAUCET					
 <ul style="list-style-type: none"> • application: one or three hole • supply line length: flexible • connection size: 3/8" • connection type: compression • deck plate: sold separately • drain assembly: metal • drain assembly type: lift rod   DURALAST™		S6700	422.25	Chrome	3
		S6700BN	674.60	Brushed Nickel	3
		DECK PLATE SOLD SEPARATELY			
		147204	41.90	Chrome	12
		147204BN	59.15	Brushed Nickel	12
 <ul style="list-style-type: none"> • application: one or three hole • supply line length: flexible • connection size: 3/8" • connection type: compression • deck plate: sold separately • drain assembly: metal • drain assembly type: lift rod   DURALAST™		S6705	485.50	Chrome	3
		S6705BN	775.80	Brushed Nickel	3
		DECK PLATE SOLD SEPARATELY			
		147204	41.90	Chrome	12
		147204BN	59.15	Brushed Nickel	12
 <ul style="list-style-type: none"> • application: one or three hole • supply line length: flexible • connection size: 3/8" • connection type: compression • deck plate: sold separately • drain assembly: 140780 sold separately   DURALAST™		S6711	561.55	Chrome	3
		S6711BN	843.30	Brushed Nickel	3
		DECK PLATE SOLD SEPARATELY			
		147204	41.90	Chrome	12
		147204BN	59.15	Brushed Nickel	12
 <ul style="list-style-type: none"> • drain assembly: metal • drain assembly type: spring loaded pop-up 		140780	94.40	Chrome	12
		140780BN	136.05	Brushed Nickel	12













06

NOTES

DURALAST™ Duralast® Cartridge

90™ Bathroom Faucets

All Brushed Nickel faucet components feature the LifeShine® Non-Tarnish Finish.

		MODEL NUMBER	LIST PRICE	FINISH/ CONNECTION	CASE QTY
TWO-HANDLE WIDESPREAD BATHROOM FAUCET					
	<ul style="list-style-type: none"> • application: three hole • centre dimensions: 8" - 16" centre • drain assembly: metal • drain assembly type: lift rod • valve sold separately 	TS6720	398.15	Chrome	3
		TS6720BN	657.05	Brushed Nickel	3
	  				
TWO-HANDLE WIDESPREAD BATHROOM FAUCET					
	<ul style="list-style-type: none"> • application: three hole • centre dimensions: 8" - 16" centre • drain assembly: metal • drain assembly type: lift rod 	9000	148.70	1/2" IPS	6
		 DURALOCK® DURALAST®			
TWO-HANDLE WALL MOUNT BATHROOM FAUCET					
	<ul style="list-style-type: none"> • application: three hole • centre dimensions: 8" centre • spout reach: 6.33" • drain assembly: 140780 sold separately • valve sold separately 	TS6730	404.05	Chrome	3
		TS6730BN	748.10	Brushed Nickel	3
	  				
	<ul style="list-style-type: none"> • application: three hole • centre dimensions: 8" centre • drain assembly: 140780 sold separately • includes: mounting brackets 	9700	219.75	1/2" CC	3
					
	<ul style="list-style-type: none"> • drain assembly: metal • drain assembly type: spring loaded pop-up 	140780	94.40	Chrome	12
		140780BN	136.05	Brushed Nickel	12

90™



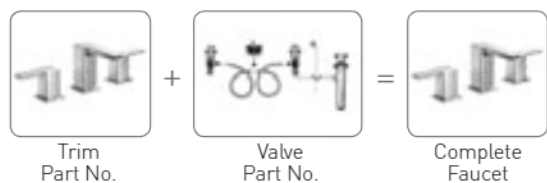

HOW TO ORDER A COMPLETE BATHROOM FAUCET



NOTES

-  Moen® **M•PACT®** Common Valve System
- DURALOCK®** Duralock™ Quick Connections
- DURALAST®** Duralast® Cartridge

All Brushed Nickel faucet components feature the LifeShine® Non-Tarnish Finish.

	MODEL NUMBER	LIST PRICE	FINISH/ CONNECTION	CASE QTY
FREESTANDING TUB FILLER				
 Ships Q3 	<ul style="list-style-type: none"> • application: one hole • showerhead type: handshower • handshower functions: one-function • handshower flow rate: 1.75 gpm (6.65 L/min) max. • spout reach: 11.00" • mounting kit: sold separately 	S905 2,070.60	Chrome	1
		S905BN 2,950.50	Brushed Nickel	1
	<ul style="list-style-type: none"> • description: single riser floor joist mounting kit • application: one hole • quarter turn stops: included 	TS50100 336.65	1/2" CC, NPT	2

HOW TO ORDER A COMPLETE FLOORMOUNT TUB FILLER











NOTES

 Moen® **M•PACT®** Common Valve System

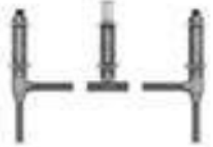
06

90^o™ Roman Tubs

All Brushed Nickel faucet components feature the LifeShine[®] Non-Tarnish Finish.

		MODEL NUMBER	LIST PRICE	FINISH/ CONNECTION	CASE QTY
TWO-HANDLE ROMAN TUB					
	<ul style="list-style-type: none"> • application: three hole • spout reach: 7.63" • valve sold separately 	TS903	564.25	Chrome	3
		TS903BN	829.10	Brushed Nickel	3
					
	<ul style="list-style-type: none"> • application: three hole • deck thickness: 1/8" to 3-3/8" rough deck • centre dimensions: adjustable • adjustable spout shank: included • test plug: included 	4792	188.00	1/2" CC	6
					
	<ul style="list-style-type: none"> • application: three hole • deck thickness: 1/8" to 1-7/8" deck • centre dimensions: 10" centre • non-adjustable spout shank: included • test plug: included 	4796 4798	179.95 179.95	1/2" CC 1/2" PEX, Cold Expansion PEX	6 6
					
	<ul style="list-style-type: none"> • description: high flow thermostatic mixing valve • 1/2" FNPT (3/8" compression adapters) • listed to ASSE Standard 1070 • max. flow rate at 45 psi = 10 gpm • tub application 	104465	223.55	1/2" FNPT	12
	<ul style="list-style-type: none"> • description: PEX transition fittings (2) and clips • adapts standard 1/2" PEX barb to 1/2" PEX cold expansion connections 	140715	11.35	1/2" PEX	200

90^o™



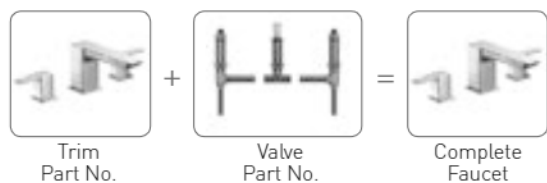



HOW TO ORDER A COMPLETE ROMAN TUB FAUCET



NOTES

 Moen[®] M•PACT[®] Common Valve System

All Brushed Nickel faucet components feature the LifeShine® Non-Tarnish Finish.

	MODEL NUMBER	LIST PRICE	FINISH/ CONNECTION	CASE QTY
TWO-HANDLE ROMAN TUB WITH HANDSHOWER				
 <ul style="list-style-type: none"> • application: four hole • showerhead type: handshower • handshower functions: one-function • handshower flow rate: 1.75 gpm (6.65 L/min) max. • spout reach: 7.63" • valve sold separately 	TS904	911.90	Chrome	3
	TS904BN	1,391.90	Brushed Nickel	3
				
 <ul style="list-style-type: none"> • application: four hole • deck thickness: 1/8" to 2-5/8" deck • centre dimensions: 10" centre • non-adjustable spout shank: included • test plug: included 	9796	358.95	1/2" CC	6
	9797	358.95	1/2" CPVC, PEX	6
				
 <ul style="list-style-type: none"> • description: high flow thermostatic mixing valve • 1/2" FNPT (3/8" compression adapters) • listed to ASSE Standard 1070 • max. flow rate at 45 psi = 10 gpm • tub application 	104465	223.55	1/2" FNPT	12
 <ul style="list-style-type: none"> • description: PEX transition fittings (2) and clips • adapts standard 1/2" PEX barb to 1/2" PEX cold expansion connections 	140715	11.35	1/2" PEX	200

M.O. 06

HOW TO ORDER A COMPLETE ROMAN TUB FAUCET

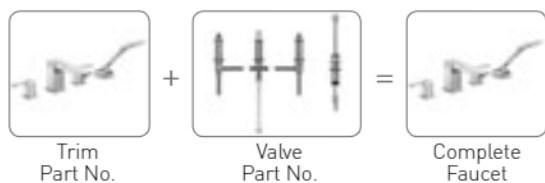











NOTES

 Moen® **M•PACT**® Common Valve System

90™ 3/4" Thermostatic Showering

All Brushed Nickel faucet components feature the LifeShine® Non-Tarnish Finish.

		MODEL NUMBER	LIST PRICE	FINISH/ CONNECTION	CASE QTY
EXACTTEMP® VALVE TRIM					
 <ul style="list-style-type: none"> valve sold separately 	 	TS3100	303.50	Chrome	3
		TS3100BN	490.85	Brushed Nickel	3
 <ul style="list-style-type: none"> ports: four adjustable temperature limit stop: included check stops: included requires: separate volume control valve 		S3371	626.05	3/4" IPS	6
VOLUME CONTROL VALVE TRIM					
 <ul style="list-style-type: none"> valve sold separately 	 	TS3300	136.45	Chrome	6
		TS3300BN	220.05	Chrome	6
 <ul style="list-style-type: none"> description: volume control valve 		S3600	141.15	3/4" IPS	12

90™

HOW TO ORDER A COMPLETE SHOWER FAUCET

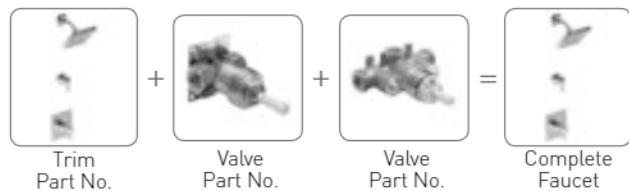

NOTES

 Moen® **M•PACT**® Common Valve System

90°™ Transfer Valve Shower Spa Components

All Brushed Nickel faucet components feature the LifeShine® Non-Tarnish Finish.

	MODEL NUMBER	LIST PRICE	FINISH/ CONNECTION	CASE QTY
3 INDEPENDENT FUNCTION TRANSFER VALVE ONLY				
 <ul style="list-style-type: none"> • use with 3362 transfer valve • valve: sold separately  	TS4173	153.20	Chrome	12
	TS4173BN	231.85	Brushed Nickel	12
 <ul style="list-style-type: none"> • ports: four • type of function: three independent functions • must be used with: Posi-Temp or Moentrol valve 	3362	215.60	1/2" CC	6
TRANSFER VALVE TRIM				
 <ul style="list-style-type: none"> • valve sold separately  	TS4172	147.60	Chrome	6
	TS4172BN	222.70	Brushed Nickel	6
 <ul style="list-style-type: none"> • type of function: two independent one shared • must be used with: Posi-Temp or Moentrol valve 	3372	188.30	1/2" CC	12
 <ul style="list-style-type: none"> • type of function: two discrete • must be used with: Posi-Temp or Moentrol valve 	3375	188.30	1/2" CC	12

HOW TO ORDER A COMPLETE TRANSFER VALVE









NOTES

 Moen® **M•PACT®** Common Valve System

M.P. 06

90™ Moentrol® Showering

All Brushed Nickel faucet components feature the LifeShine® Non-Tarnish Finish.

		MODEL NUMBER	LIST PRICE	FINISH/ CONNECTION	CASE QTY
MOENTROL® TUB/SHOWER					
	<ul style="list-style-type: none"> showerhead functions: one-function showerhead type: rainshower showerhead size: 6" diameter spray head showerhead flow rate: 2.5 gpm (9.5 L/min) max. spout length: 7 1/4" spout connection type: slip fit tub spout type: diverter valve sold separately 	TS3713	386.80	Chrome	3
		TS3713BN	711.40	Brushed Nickel	3
	<ul style="list-style-type: none"> ports: four adjustable temperature limit stop: included includes: volume control 	3510	210.05	1/2" IPS	6
		3520	210.05	1/2" CC	6
	<ul style="list-style-type: none"> ports: four adjustable temperature limit stop: included includes: volume control check stops: included 	3570	232.40	1/2" CC	6
MOENTROL® SHOWER ONLY					
	<ul style="list-style-type: none"> showerhead functions: one-function showerhead type: rainshower showerhead size: 6" diameter spray head showerhead flow rate: 2.5 gpm (9.5 L/min) max. valve sold separately 	TS3715	268.65	Chrome	3
		TS3715BN	578.85	Brushed Nickel	3
	<ul style="list-style-type: none"> ports: four adjustable temperature limit stop: included includes: volume control 	3510	210.05	1/2" IPS	6
		3520	210.05	1/2" CC	6
	<ul style="list-style-type: none"> ports: four adjustable temperature limit stop: included includes: volume control check stops: included 	3570	232.40	1/2" CC	6

90™

HOW TO ORDER A COMPLETE SHOWERING FAUCET





NOTES

-  Moen® **M•PACT**® Common Valve System
-  Immersion® Rainshower

90°™ Moentrol® Showering

All Brushed Nickel faucet components feature the LifeShine® Non-Tarnish Finish.

	MODEL NUMBER	LIST PRICE	FINISH/ CONNECTION	CASE QTY
MOENTROL® VALVE TRIM				
 <ul style="list-style-type: none"> valve sold separately 	TS3711	191.90	Chrome	3
	TS3711BN	438.20	Brushed Nickel	3
 <ul style="list-style-type: none"> ports: four adjustable temperature limit stop: included includes: volume control 	3510	210.05	1/2" IPS	6
	3520	210.05	1/2" CC	6
 <ul style="list-style-type: none"> ports: four adjustable temperature limit stop: included includes: volume control check stops: included 	3570	232.40	1/2" CC	6

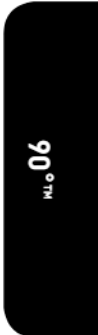

HOW TO ORDER A COMPLETE VALVE











NOTES

 Moen® **M•PACT®** Common Valve System

90™ Posi-Temp® Showering

All Brushed Nickel faucet components feature the LifeShine® Non-Tarnish Finish.

		MODEL NUMBER	LIST PRICE	FINISH/ CONNECTION	CASE QTY
POSI-TEMP® TUB/SHOWER					
	<ul style="list-style-type: none"> • showerhead functions: one-function • showerhead type: rainshower • showerhead size: 6" diameter spray head • showerhead flow rate: 2.5 gpm (9.5 L/min) max. • spout length: 7 1/4" • spout connection type: slip fit • tub spout type: diverter • valve sold separately 	TS2713	322.50	Chrome	3
		TS2713BN	544.75	Brushed Nickel	3
					
	<ul style="list-style-type: none"> • showerhead functions: one-function • showerhead type: eco-performance rainshower • showerhead size: 6" diameter spray head • showerhead flow rate: 1.75 gpm (6.65 L/min) max. • spout length: 7 1/4" • spout connection type: slip fit • tub spout type: diverter • valve sold separately 	TS2713EP	322.50	Chrome	3
		TS2713EPBN	544.75	Brushed Nickel	3
					
	<ul style="list-style-type: none"> • ports: four • adjustable temperature limit stop: included 	2510	152.20	1/2" IPS	6
		2520	152.20	1/2" CC	6
					
	<ul style="list-style-type: none"> • ports: four • adjustable temperature limit stop: included • quarter turn stops: included 	2570	194.75	1/2" CC	6
		2590	194.75	1/2" IPS	6
					

90™

HOW TO ORDER A COMPLETE TUB/SHOWER FAUCET















NOTES

-  Moen® **M•PACT®** Common Valve System
-  Immersion® Rainshower

90°™ Posi-Temp® Showering

All Brushed Nickel faucet components feature the LifeShine® Non-Tarnish Finish.

		MODEL NUMBER	LIST PRICE	FINISH/ CONNECTION	CASE QTY
POSI-TEMP® SHOWER ONLY					
	<ul style="list-style-type: none"> • showerhead functions: one-function • showerhead type: rainshower • showerhead size: 6" diameter spray head • showerhead flow rate: 2.5 gpm (9.5 L/min) max. • valve sold separately 	TS2712	251.80	Chrome	3
	  IMMERSION	TS2712BN	430.70	Brushed Nickel	3
	<ul style="list-style-type: none"> • showerhead functions: one-function • showerhead type: eco-performance rainshower • showerhead size: 6" diameter spray head • showerhead flow rate: 1.75 gpm (6.65 L/min) max. • valve sold separately 	TS2712EP	251.80	Chrome	3
	   IMMERSION	TS2712EPBN	430.70	Brushed Nickel	3
	<ul style="list-style-type: none"> • ports: four • adjustable temperature limit stop: included 	2510	152.20	1/2" IPS	6
		2520	152.20	1/2" CC	6
	<ul style="list-style-type: none"> • ports: four • adjustable temperature limit stop: included • quarter turn stops: included 	2570	194.75	1/2" CC	6
		2590	194.75	1/2" IPS	6

M.O. 06

HOW TO ORDER A COMPLETE SHOWER FAUCET





NOTES

-  Moen® **M•PACT**® Common Valve System
-  Immersion® Rainshower

90^o™ Posi-Temp[®] Showering

All Brushed Nickel faucet components feature the LifeShine[®] Non-Tarnish Finish.

		MODEL NUMBER	LIST PRICE	FINISH/ CONNECTION	CASE QTY
POSI-TEMP[®] VALVE TRIM					
 <ul style="list-style-type: none"> valve sold separately 		TS2711	172.00	Chrome	3
		TS2711BN	321.60	Brushed Nickel	3
 <ul style="list-style-type: none"> ports: four adjustable temperature limit stop: included 		2510	152.20	1/2" IPS	6
		2520	152.20	1/2" CC	6
 <ul style="list-style-type: none"> ports: four adjustable temperature limit stop: included quarter turn stops: included 		2570	194.75	1/2" CC	6
		2590	194.75	1/2" IPS	6

90^o™

HOW TO ORDER A COMPLETE VALVE



NOTES

 Moen[®] M•PACT[®] Common Valve System

90™ Perfectly Matched Bath Accessories

Moen® makes it easy to coordinate the entire style and look of the bathroom. Our 90™ bath accessories perfectly match the style and finish of our 90° faucets. Total coordination of the bath has never been easier.

MODEL NUMBER	LIST PRICE EACH	DESCRIPTION	QTY
Chrome (CH)			
YB8801CH	65.55	Toilet Tank Lever	24
YB8803CH	58.30	Robe Hook	24
YB8805CH	11.50	Cabinet Knob	48
YB8807CH	23.00	Drawer Pull	48
 YB8808CH	110.50	Pivoting Paper Holder	6
YB8818CH	123.70	18" Towel Bar	6
YB8824CH	127.60	24" Towel Bar	6
YB8886CH	81.80	Mini Towel Bar	6
Brushed Nickel (BN)			
YB8801BN	68.80	Toilet Tank Lever	24
YB8803BN	61.25	Robe Hook	24
YB8805BN	13.35	Cabinet Knob	48
YB8807BN	24.80	Drawer Pull	48
 YB8808BN	116.05	Pivoting Paper Holder	6
YB8818BN	129.90	18" Towel Bar	6
YB8824BN	134.00	24" Towel Bar	6
YB8886BN	85.90	Mini Towel Bar	6



YB8801 Toilet Tank Lever



YB8803 Robe Hook



YB8805 Cabinet Knob



YB8807 Drawer Pull



YB8808 Pivoting Paper Holder



YB8818 18" Towel Bar



YB8824 24" Towel Bar



YB8886 Mini Towel Bar



YG8824 1-1/4" Diameter x 24" length (Concealed Screw)

GRAB BARS

PERFECTLY MATCHED to Moen® 90™ faucets and bath accessories. ADA-compliant.



SecureMount™ Grab Bars are manufactured with an innovative flange design that makes it easy to connect to the stud at multiple points.

To install grab bars securely without studs, use SecureMount™ Anchors. Sold separately.

MODEL NUMBER	LIST PRICE EACH	DESCRIPTION	QTY
1-1/4" • Chrome (CH)			
YG8812CH	135.45	12" Grab Bar	6
YG8818CH	141.55	18" Grab Bar	6
YG8824CH	147.80	24" Grab Bar	6
YG8836CH	168.35	36" Grab Bar	6
1-1/4" • Brushed Nickel (BN)			
YG8812BN	146.35	12" Grab Bar	6
YG8818BN	153.50	18" Grab Bar	6
YG8824BN	165.65	24" Grab Bar	6
YG8836BN	186.50	36" Grab Bar	6
SecureMount Anchors™			
SMA1005CH	21.20	SecureMount Anchors™ (1 pc Chrome Mounting Plates)	3
SMA1000WB	48.80	SecureMount Anchors™ (2 pc Old World Bronze Mounting Plates)	24



Complies with Americans with Disabilities Act (ADA) specifications. SecureMount™ Grab Bars are tested to withstand 500 lb. pull when securely installed per instructions.

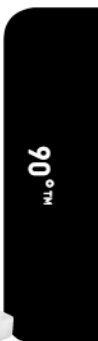



90™











LIGHTING

MODEL NUMBER	LIST PRICE EACH	DESCRIPTION	QTY
Chrome (CH)			
YB8861CH	164.80	One-Globe Light	2
YB8862CH	230.70	Two-Globe Light	2
YB8863CH	253.45	Three-Globe Light	2
YB8864CH	346.10	Four-Globe Light	2
Brushed Nickel (BN)			
YB8861BN	206.00	One-Globe Light	2
YB8862BN	288.25	Two-Globe Light	2
YB8863BN	316.85	Three-Globe Light	2
YB8864BN	432.55	Four-Globe Light	2
Replacement Globe			
YB8869	29.40	Replacement Globe Service Kit	3



Bulbs not included.

All 90™ lighting fixtures can be mounted facing either upward or downward.

	MODEL NUMBER	LIST PRICE	FINISH/ CONNECTION	CASE QTY
ONE-HANDLE BATHROOM FAUCET				
 <ul style="list-style-type: none"> • application: one hole • supply line length: flexible • connection size: 3/8" • connection type: compression • drain assembly : metal • drain assembly type: lift rod • red/blue markings: included   DURALAST™	S8000  S8000BLC*	422.25 775.80	Chrome Matte Black/Chrome	3 3
	TWO-HANDLE WIDESPREAD BATHROOM FAUCET			
 <ul style="list-style-type: none"> • application: three hole • centre dimensions: 8" - 16" centre • drain assembly : metal • drain assembly type: lift rod • red/blue markings: included • valve sold separately   	TS8002  TS8002BLC*	398.15 755.60	Chrome Matte Black/Chrome	3 3
	 <ul style="list-style-type: none"> • application: three hole • centre dimensions: 8" - 16" centre • drain assembly : metal • drain assembly type: lift rod  DURALOCK® DURALAST®	9000	148.70	1/2" IPS

HOW TO ORDER A COMPLETE BATHROOM FAUCET

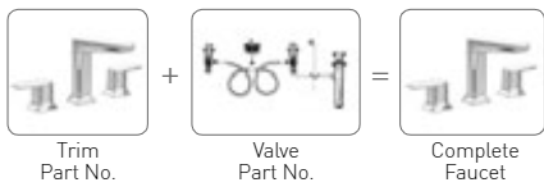







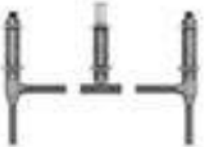

NOTES

- Moën® **M•PACT®** Common Valve System
- DURALOCK®** Duralock® Quick Connections
- DURALAST®** Duralast® Cartridge
- *Ships Q3



VIA™ Roman Tubs

	MODEL NUMBER	LIST PRICE	FINISH/ CONNECTION	CASE QTY
TWO-HANDLE ROMAN TUB				
<p>NEW! Ships Q2</p>  <ul style="list-style-type: none"> • application: three hole • flow rate: unrestricted • spout reach: 8.14" • valve: sold separately 	TS955	564.25	Chrome	-
 <ul style="list-style-type: none"> • application: three hole • deck thickness: 1/8" to 3-3/8" rough deck • centre dimensions: adjustable • adjustable spout shank: included • test plug: included 	4792	188.00	1/2" CC	6
 <ul style="list-style-type: none"> • application: three hole • deck thickness: 1/8" to 1-7/8" deck • centre dimensions: 10" centre • non-adjustable spout shank: included • test plug: included 	4796	179.95	1/2" CC	6
	4798	179.95	1/2" PEX, Cold Expansion PEX	6
 <ul style="list-style-type: none"> • description: high flow thermostatic mixing valve • 1/2" FNPT (3/8" compression adapters) • listed to ASSE Standard 1070 • max. flow rate at 45 psi = 10 gpm • tub application 	104465	223.55	1/2" FNPT	12
 <ul style="list-style-type: none"> • description: PEX transition fittings (2) and clips • adapts standard 1/2" PEX barb to 1/2" PEX cold expansion connections 	140715	11.35	1/2" PEX	200

VIA™



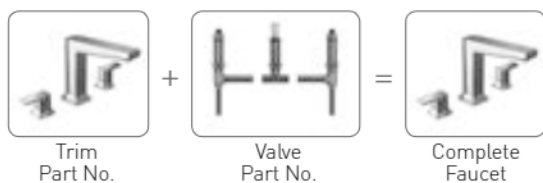





HOW TO ORDER A COMPLETE ROMAN TUB FAUCET



NOTES

 Moen® **M•PACT®** Common Valve System

VIA™ 3/4" Thermostatic Showering

	MODEL NUMBER	LIST PRICE	FINISH/ CONNECTION	CASE QTY
EXACTTEMP® VALVE ONLY				
 <ul style="list-style-type: none"> requires: separate volume control valve valve: sold separately 	TS9711	303.50	Chrome	3
 <ul style="list-style-type: none"> description: thermostatic rough-in valve ports: four adjustable temp limit stop: included check stops: included 	S3371	626.05	3/4" IPS	6
EXACTTEMP® VOLUME CONTROL VALVE ONLY				
 <ul style="list-style-type: none"> valve: sold separately 	TS9712	136.45	Chrome	6
 <ul style="list-style-type: none"> description: volume control rough-in valve includes: volume control 	S3600	141.15	3/4" IPS	12

HOW TO ORDER A COMPLETE EXACTTEMP® VALVE















NOTES

Moeno® **M•PACT®** Common Valve System



VIA™ Transfer Valve Shower Spa Components

		MODEL NUMBER	LIST PRICE	FINISH/ CONNECTION	CASE QTY
3 INDEPENDENT FUNCTION TRANSFER VALVE ONLY					
 <ul style="list-style-type: none"> • use with 3362 transfer valve • valve: sold separately  		TS2172	153.20	Chrome	12
 <ul style="list-style-type: none"> • ports: four • type of function: three independent functions • must be used with: Posi-Temp or Moentrol valve 		3362	215.60	1/2" CC	6
2/3 FUNCTION TRANSFER VALVE ONLY					
 <ul style="list-style-type: none"> • use with 3372 or 3375 transfer valve • valve: sold separately  		TS2171	147.60	Chrome	12
 <ul style="list-style-type: none"> • type of function: two independent one shared • must be used with: Posi-Temp® or Moentrol® valve 		3372	188.30	1/2" CC	12
 <ul style="list-style-type: none"> • type of function: two independent functions • must be used with: Posi-Temp® or Moentrol® valve 		3375	188.30	1/2" CC	12

VIA™









HOW TO ORDER A COMPLETE VALVE



NOTES

Moentrol Moen® M•FACT® Common Valve System

VIA™ Posi-Temp® Showering

		MODEL NUMBER	LIST PRICE	FINISH/ CONNECTION	CASE QTY
POSI-TEMP® TUB/SHOWER					
	<ul style="list-style-type: none"> • showerhead functions: one-function • showerhead type: rainshower • showerhead size: 6" diameter spray head • showerhead flow rate: 2.5 gpm (9.5 L/min) max. • spout length: 7 1/4" • spout connection type: slip fit • tub spout type: diverter • red/blue markings: included • valve sold separately 	TS8713	322.50	Chrome	3
					
	<ul style="list-style-type: none"> • showerhead functions: one-function • showerhead type: eco-performance showerhead • showerhead size: 6" diameter spray head • showerhead flow rate: 1.75 gpm (6.65 L/min) max. • spout length: 7 1/4" • spout connection type: slip fit • tub spout type: diverter • red/blue markings: included • valve sold separately 	TS8713EP	322.50	Chrome	3
					
	<ul style="list-style-type: none"> • ports: four • adjustable temp limit stop: included 	2510	152.20	1/2" IPS	6
		2520	152.20	1/2" CC	6
	<ul style="list-style-type: none"> • ports: four • adjustable temp limit stop: included • quarter turn stops: included 	2570	194.75	1/2" CC	6
		2590	194.75	1/2" IPS	6

HOW TO ORDER A COMPLETE TUB/SHOWER FAUCET

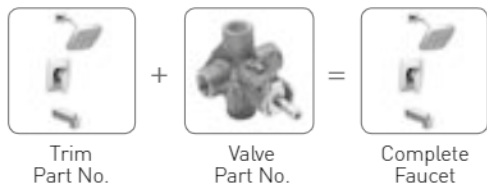









NOTES

- Moen® **M•PACT**® Common Valve System
- **IMMERISION** Immersion® Rainshower



VIA™ Posi-Temp® Showering

		MODEL NUMBER	LIST PRICE	FINISH/ CONNECTION	CASE QTY
POSI-TEMP® SHOWER ONLY					
 <ul style="list-style-type: none"> • showerhead functions: one-function • showerhead type: rainshower • showerhead size: 6" diameter spray head • showerhead flow rate: 2.5 gpm (9.5 L/min) max. • red/blue markings: included • valve sold separately 		TS8712	251.80	Chrome	3
 <ul style="list-style-type: none"> • showerhead functions: one-function • showerhead type: eco-performance showerhead • showerhead size: 6" diameter spray head • showerhead flow rate: 1.75 gpm (6.65 L/min) max. • red/blue markings: included • valve sold separately 		TS8712EP	251.80	Chrome	3
 <ul style="list-style-type: none"> • ports: four • adjustable temp limit stop: included 		2510 2520	152.20	1/2" IPS 1/2" CC	6 6
 <ul style="list-style-type: none"> • ports: four • adjustable temp limit stop: included • quarter turn stops: included 		2570 2590	194.75	1/2" CC 1/2" IPS	6 6







VIA™

HOW TO ORDER A COMPLETE SHOWER FAUCET



NOTES

- Moën® M•PACT® Common Valve System
- IMMERSSION® Immersion® Rainshower

		MODEL NUMBER	LIST PRICE	FINISH/ CONNECTION	CASE QTY
POSI-TEMP® VALVE TRIM					
 <ul style="list-style-type: none"> • valve sold separately • red/blue markings: included  		TS8711	172.00	Chrome	3
 <ul style="list-style-type: none"> • ports: four • adjustable temp limit stop: included 		2510	152.20	1/2" IPS	6
		2520	152.20	1/2" CC	6
 <ul style="list-style-type: none"> • ports: four • adjustable temp limit stop: included • quarter turn stops: included 		2570	194.75	1/2" CC	6
		2590	194.75	1/2" IPS	6



HOW TO ORDER A COMPLETE VALVE



NOTES

Moeno M•PACT® Common Valve System

VIA™ Perfectly Matched Bath Accessories

Moen makes it easy to coordinate the entire style and look of the bathroom. Our Via™ bath accessories perfectly match the style and finish of our Via™ faucets. Total coordination of the bath has never been easier.

MODEL NUMBER	LIST PRICE EACH	DESCRIPTION	QTY
Chrome (CH)			
YB5003CH	58.30	Robe Hook	24
<i>Pivoting</i> YB5008CH	110.50	Pivoting Paper Holder	6
YB5012CH	115.45	12" Towel Bar	6
YB5018CH	123.70	18" Towel Bar	6
YB5024CH	127.60	24" Towel Bar	6
YB5086CH	81.80	Mini Towel Bar	6



YB5003
Robe Hook



YB5008
Pivoting
Paper Holder



YB5086
Mini Towel Bar



YB5012
12" Towel Bar











YB5018
18" Towel Bar



YB5024
24" Towel Bar



All Brushed Nickel faucet components feature the LifeShine® Non-Tarnish Finish.

	MODEL NUMBER	LIST PRICE	FINISH/ CONNECTION	CASE QTY
ONE-HANDLE BATHROOM FAUCET				
 <ul style="list-style-type: none"> • application: one to three hole • supply line length: flexible • connection size: 3/8" • connection type: compression • deckplate: included • drain assembly: metal • drain assembly type: lift rod   DURALAST®	S6910	422.00	Chrome	3
	S6910BN	674.60	Brushed Nickel	3
	S6910BL	674.60	Matte Black	3
TWO-HANDLE WIDESPREAD BATHROOM FAUCET				
 <ul style="list-style-type: none"> • application: three hole • center dimensions: 8" - 16" center • drain assembly: metal • drain assembly type: lift rod • valve: sold separately   	TS6925	398.15	Chrome	3
	TS6925BN	657.05	Brushed Nickel	3
	TS6925BL	657.05	Matte Black	3
 <ul style="list-style-type: none"> • application: three hole • center dimensions: 8" - 16" center • drain assembly: metal • drain assembly type: lift rod  DURALOCK® DURALAST®	9000	148.70	1/2" IPS	6

HOW TO ORDER A COMPLETE BATHROOM FAUCET

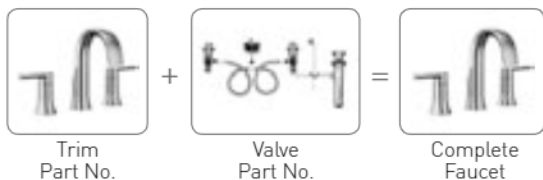

NOTES





-  Moen® **M•PACT®** Common Valve System
- DURALOCK®** Duralock® Quick Connections
- DURALAST®** Duralast® Cartridge

Refer to specification sheet for critical dimensions for installation.



NEW! DOUX™ Tub Fillers

All Brushed Nickel faucet components feature the LifeShine® Non-Tarnish Finish.

	MODEL NUMBER	LIST PRICE	FINISH/ CONNECTION	CASE QTY
FREESTANDING TUB FILLER				
 <ul style="list-style-type: none"> • application: one hole • showerhead type: handshower • handshower functions: one-function • handshower flow rate: 1.75 gpm (6.65 L/min) max. • spout reach: 11.00" • mounting kit: sold separately  	S3105	2,070.60	Chrome	1
	S3105BN	2,950.50	Brushed Nickel	1
	S3105BL	2,950.50	Matte Black	1
 <ul style="list-style-type: none"> • description: single riser floor joist mounting kit • application: one hole • quarter turn stops: included 	TS50100	336.65	1/2" CC, NPT	2

DOUX™





HOW TO ORDER A COMPLETE FREESTANDING TUB FILLER FAUCET



NOTES

 Moen® **M•PACT**® Common Valve System

All Brushed Nickel faucet components feature the LifeShine® Non-Tarnish Finish.

	MODEL NUMBER	LIST PRICE	FINISH/ CONNECTION	CASE QTY
TWO-HANDLE ROMAN TUB				
 <ul style="list-style-type: none"> • application: three hole • spout reach: 8.40" • valve: sold separately 	TS983	474.80	Chrome	3
	TS983BN	732.20	Brushed Nickel	3
	TS983BL	732.20	Matte Black	3
 <ul style="list-style-type: none"> • application: three hole • deck thickness: 1/8" to 3-3/8" rough-in deck • center dimensions: adjustable • adjustable spout shank: included • test plug: included 	4792	188.00	1/2" CC	6
 <ul style="list-style-type: none"> • application: three hole • deck thickness: 1/8" to 1-3/16" rough-in deck • center dimensions: 10" center • non-adjustable spout shank: included • test plug: included 	4796	179.95	1/2" CC	6
 <ul style="list-style-type: none"> • description: high flow thermostatic mixing valve • 1/2" FNPT (3/8" compression adapters) • listed to ASSE Standard 1070 • max. flow rate at 45 psi = 10 gpm • tub application 	104465	223.55	1/2" FNPT	12
 <ul style="list-style-type: none"> • description: PEX transition fittings (2) and clips • connections: adapts standard 1/2" PEX barb to 1/2" PEX cold expansion 	140715	11.35	1/2" PEX	200

HOW TO ORDER A COMPLETE ROMAN TUB FAUCET

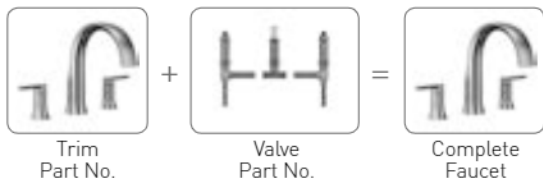







NOTES

 Moen® **M•PACT®** Common Valve System



NEW! DOUX™ Roman Tub

All Brushed Nickel faucet components feature the LifeShine® Non-Tarnish Finish.

	MODEL NUMBER	LIST PRICE	FINISH/ CONNECTION	CASE QTY
TWO-HANDLE ROMAN TUB WITH HANDSHOWER				
 <ul style="list-style-type: none"> • application: four hole • showerhead type: handshower • handshower flow rate: 1.75 gpm (6.65 L/min) max. • spray functions: one-function • spout reach: 8.40" • valve: sold separately 	TS984	755.35	Chrome	3
	TS984BN	1,226.15	Brushed Nickel	3
	TS984BL	1,226.15	Matte Black	3
 <ul style="list-style-type: none"> • application: four hole • deck thickness: 1/8" to 2-5/8" deck • centre dimensions: 10" centre • non-adjustable spout shank: included • test plug: included 	9796	358.95	1/2" CC	6
	9797	358.95	1/2" CPVC, PEX	6
 <ul style="list-style-type: none"> • description: high flow thermostatic mixing valve • 1/2" FNPT (3/8" compression adapters) • listed to ASSE Standard 1070 • max. flow rate at 45 psi = 10 gpm • tub application 	104465	223.55	1/2" FNPT	12
 <ul style="list-style-type: none"> • description: PEX transition fittings (2) and clips • connections: adapts standard 1/2" PEX barb to 1/2" PEX cold expansion 	140715	11.35	1/2" PEX	200

DOUX™

HOW TO ORDER A COMPLETE ROMAN TUB FAUCET

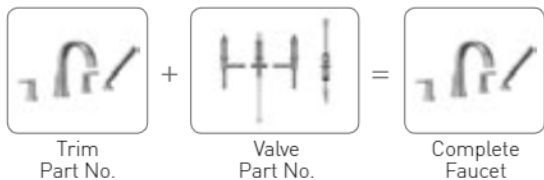









NOTES

Moën® M•PACT® Common Valve System

NEW! DOUX™ 3/4" Thermostatic Showering

All Brushed Nickel faucet components feature the LifeShine® Non-Tarnish Finish.

	MODEL NUMBER	LIST PRICE	FINISH/ CONNECTION	CASE QTY
EXACTTEMP® VALVE ONLY				
 <ul style="list-style-type: none"> requires: separate volume control valve valve: sold separately 	TS3101	336.30	Chrome	3
	TS3101BN	524.75	Brushed Nickel	3
	TS3101BL	524.75	Matte Black	3
 <ul style="list-style-type: none"> description: thermostatic rough-in valve ports: four adjustable temp limit stop: included check stops: included 	S3371	626.05	3/4" IPS	6

EXACTTEMP® VOLUME CONTROL VALVE ONLY				
 <ul style="list-style-type: none"> valve: sold separately 	TS3102	160.90	Chrome	6
	TS3102BN	231.95	Brushed Nickel	6
	TS3102BL	231.95	Matte Black	6
 <ul style="list-style-type: none"> description: volume control rough-in valve includes: volume control 	S3600	141.15	3/4" IPS	12

HOW TO ORDER A COMPLETE EXACTTEMP® VALVE

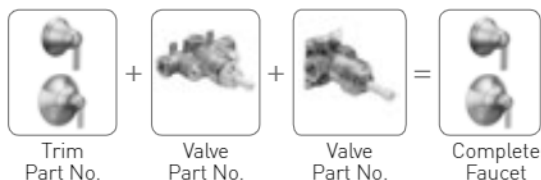





NOTES







 Moen® **M•PACT®** Common Valve System



NEW! DOUX™ Transfer Valve Shower Spa Components

All Brushed Nickel faucet components feature the LifeShine® Non-Tarnish Finish.

	MODEL NUMBER	LIST PRICE	FINISH/ CONNECTION	CASE QTY
3 INDEPENDENT FUNCTION TRANSFER VALVE ONLY				
 <ul style="list-style-type: none"> • use with 3362 transfer valve • valve: sold separately 	TS9205	182.70	Chrome	12
	TS9205BN	287.40	Brushed Nickel	12
	TS9205BL	287.40	Matte Black	12
 <ul style="list-style-type: none"> • ports: four • type of function: three independent functions • must be used with: Posi-Temp® or Moentrol® valve® 	3362	215.60	1/2" CC	6

2/3 FUNCTION TRANSFER VALVE ONLY				
 <ul style="list-style-type: none"> • use with 3372 or 3375 transfer valve • valve: sold separately 	TS9204	177.10	Chrome	12
	TS9204BN	278.40	Brushed Nickel	12
	TS9204BL	278.40	Matte Black	12
 <ul style="list-style-type: none"> • type of function: two independent one shared • must be used with: Posi-Temp® or Moentrol® valve 	3372	188.30	1/2" CC	12
 <ul style="list-style-type: none"> • type of function: two independent functions • must be used with: Posi-Temp® or Moentrol® valve 	3375	188.30	1/2" CC	12

DOUX™

HOW TO ORDER A COMPLETE TRANSFER VALVE



















NOTES

 Moen® **M•PACT®** Common Valve System
DURALAST® Duralast® Cartridge

DOUX™ Moentrol® Showering

All Brushed Nickel faucet components feature the LifeShine® Non-Tarnish Finish.

	MODEL NUMBER	LIST PRICE	FINISH/ CONNECTION	CASE QTY
MOENTROL® TUB/SHOWER				
  <ul style="list-style-type: none"> • showerhead type: showerhead sold separately • spout length: 7 3/4" • spout connection type: slip fit • tub spout type: diverter • valve: sold separately  	TS3203NH	358.45	Chrome	4
	TS3203NHBN	560.75	Brushed Nickel	4
	TS3203NHBL	560.75	Matte Black	4
  <ul style="list-style-type: none"> • description: pressure balanced valve with volume control • ports: four • adjustable temp limit stop: included • checks: included • includes: volume control 	3510	210.05	1/2" IPS	6
	3520	210.05	1/2" CC	6
  <ul style="list-style-type: none"> • description: pressure balanced valve with volume control • ports: four • adjustable temp limit stop: included • check stops: included • includes: volume control 	3570	232.40	1/2" CC	6

MOENTROL® SHOWER ONLY				
  <ul style="list-style-type: none"> • showerhead type: showerhead sold separately • valve: sold separately  	TS3202NH	265.35	Chrome	4
	TS3202NHBN	495.45	Brushed Nickel	4
	TS3202NHBL	495.45	Matte Black	4
  <ul style="list-style-type: none"> • description: pressure balanced valve with volume control • ports: four • adjustable temp limit stop: included • checks: included • includes: volume control 	3510	210.05	1/2" IPS	6
	3520	210.05	1/2" CC	6
  <ul style="list-style-type: none"> • description: pressure balanced valve with volume control • ports: four • adjustable temp limit stop: included • check stops: included • includes: volume control 	3570	232.40	1/2" CC	6

HOW TO ORDER A COMPLETE TUB/SHOWER FAUCET









NOTES

 Moen® **M•PACT®** Common Valve System



NEW! DOUX™ Moentrol® Showering

All Brushed Nickel faucet components feature the LifeShine® Non-Tarnish Finish.

		MODEL NUMBER	LIST PRICE	FINISH/ CONNECTION	CASE QTY
MOENTROL® VALVE ONLY					
 <p>NEW!</p> <ul style="list-style-type: none"> valve: sold separately  		TS3201	231.40	Chrome	3
		TS3201BN	464.85	Brushed Nickel	3
		TS3201BL	464.85	Matte Black	3
 	<ul style="list-style-type: none"> description: pressure balanced valve with volume control 	3510	210.05	1/2" IPS	6
	<ul style="list-style-type: none"> ports: four adjustable temp limit stop: included checks: included includes: volume control 	3520	210.05	1/2" CC	6
 	<ul style="list-style-type: none"> description: pressure balanced valve with volume control 	3570	232.40	1/2" CC	6
	<ul style="list-style-type: none"> ports: four adjustable temp limit stop: included check stops: included includes: volume control 				

DOUX™









HOW TO ORDER A COMPLETE VALVE



NOTES

Moentrol® Moentrol® Common Valve System

All Brushed Nickel faucet components feature the LifeShine® Non-Tarnish Finish.

	MODEL NUMBER	LIST PRICE	FINISH/ CONNECTION	CASE QTY
POSI-TEMP® TUB/SHOWER				
	<ul style="list-style-type: none"> • showerhead functions: one-function • showerhead type: standard • showerhead size: 7" diameter spray head • showerhead flow rate: 2.5 gpm [9.5 L/min] max. • spout length: 7-3/4" • spout connection type: slip fit • tub spout type: diverter • valve: sold separately 	TS2203 TS2203BN TS2203BL	377.30 Chrome 590.40 Brushed Nickel 590.40 Matte Black	4 4 4
				
	<ul style="list-style-type: none"> • showerhead functions: one-function • showerhead type: eco-performance showerhead • showerhead size: 7" diameter spray head • showerhead flow rate: 1.75 gpm [6.65 L/min] max. • spout length: 7-3/4" • spout connection type: slip fit • tub spout type: diverter • valve: sold separately 	TS2203EP TS2203EPBN TS2203EPBL	377.30 Chrome 590.40 Brushed Nickel 590.40 Matte Black	4 4 4
				
	<ul style="list-style-type: none"> • description: pressure balanced cycling valve • ports: four • adjustable temp limit stop: included 	2510 2520	152.20 1/2" IPS 152.20 1/2" CC	6 6
				
	<ul style="list-style-type: none"> • description: pressure balanced cycling valve • ports: four • adjustable temp limit stop: included • quarter turn stops: included 	2570 2590	194.75 1/2" CC 194.75 1/2" IPS	6 6
				

HOW TO ORDER A COMPLETE TUB/SHOWER FAUCET

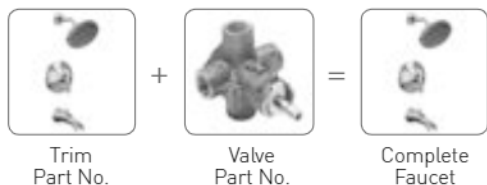













NOTES

 Moen® **M•PACT**® Common Valve System



NEW! DOUX™ Posi-Temp® Showering

All Brushed Nickel faucet components feature the LifeShine® Non-Tarnish Finish.

		MODEL NUMBER	LIST PRICE	FINISH/ CONNECTION	CASE QTY
POSI-TEMP® SHOWER ONLY					
 <ul style="list-style-type: none"> • showerhead functions: one-function • showerhead type: standard • showerhead size: 7" diameter spray head • showerhead flow rate: 2.5 gpm (9.5 L/min) max. • valve: sold separately 		TS2202	294.55	Chrome	4
		TS2202BN	503.95	Brushed Nickel	4
		TS2202BL	503.95	Matte Black	4
  					
 <ul style="list-style-type: none"> • showerhead functions: one-function • showerhead type: eco-performance showerhead • showerhead size: 7" diameter spray head • showerhead flow rate: 1.75 gpm (6.65 L/min) max. • valve: sold separately 		TS2202EP	294.55	Chrome	4
		TS2202EPBN	503.95	Brushed Nickel	4
		TS2202EPBL	503.95	Matte Black	4
   					
 	• description: pressure balanced cycling valve	2510	152.20	1/2" IPS	6
	• ports: four • adjustable temp limit stop: included	2520	152.20	1/2" CC	6
 	• description: pressure balanced cycling valve	2570	194.75	1/2" CC	6
	• ports: four • adjustable temp limit stop: included • quarter turn stops: included	2590	194.75	1/2" IPS	6

DOUX™

HOW TO ORDER A COMPLETE SHOWER FAUCET

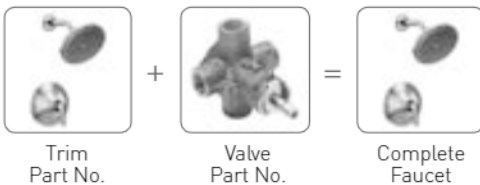









NOTES

Moeno® M•PACT® Common Valve System

NEW! **DOUX™** Posi-Temp® Showering

All Brushed Nickel faucet components feature the LifeShine® Non-Tarnish Finish.

		MODEL NUMBER	LIST PRICE	FINISH/ CONNECTION	CASE QTY
POSI-TEMP® VALVE ONLY					
   	<ul style="list-style-type: none"> • showerhead type: showerhead sold separately • valve: sold separately 	TS2201	201.20	Chrome	3
		TS2201BN	376.20	Brushed Nickel	3
		TS2201BL	376.20	Matte Black	3
 	<ul style="list-style-type: none"> • description: pressure balanced cycling valve • ports: four • adjustable temp limit stop: included 	2510	152.20	1/2" IPS	6
		2520	152.20	1/2" CC	6
 	<ul style="list-style-type: none"> • description: pressure balanced cycling valve • ports: four • adjustable temp limit stop: included • quarter turn stops: included 	2570	194.75	1/2" CC	6
		2590	194.75	1/2" IPS	6

HOW TO ORDER A COMPLETE VALVE

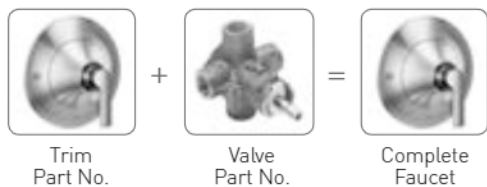

NOTES

 Moen® **M•PACT®** Common Valve System



DOUX™ Perfectly Matched Bath Accessories

Moen® makes it easy to coordinate the entire style and look of the bathroom. Our Doux™ bath accessories perfectly match the style and finish of our Doux™ faucets. Total coordination of the bath has never been easier.

MODEL NUMBER	LIST PRICE EACH	DESCRIPTION	QTY
Chrome (CH)			
YB0201CH	65.55	Tank Lever	24
YB0203CH	58.30	Single Robe Hook	24
<i>Pivoting</i> YB0208CH	110.50	Pivoting Paper Holder	6
YB0218CH	123.70	18" Towel Bar	6
YB0224CH	127.60	24" Towel Bar	6
YB0286CH	81.80	Hand Towel Bar	6
Brushed Nickel (BN)			
YB0201BN	68.80	Tank Lever	24
YB0203BN	61.25	Single Robe Hook	24
<i>Pivoting</i> YB0208BN	116.05	Pivoting Paper Holder	6
YB0218BN	129.90	18" Towel Bar	6
YB0224BN	134.00	24" Towel Bar	6
YB0286BN	85.90	Hand Towel Bar	6
Matte Black (BL)			
YB0201BL	68.80	Tank Lever	24
YB0203BL	61.25	Single Robe Hook	24
<i>Pivoting</i> YB0208BL	116.05	Pivoting Paper Holder	6
YB0218BL	129.90	18" Towel Bar	6
YB0224BL	134.00	24" Towel Bar	6
YB0286BL	85.90	Hand Towel Bar	6



YB0201 Tank Lever



YB0203 Single Robe Hook



YB0208 *Pivoting* Pivoting Paper Holder



YB0218 18" Towel Bar



YB0224 24" Towel Bar



YB8486 Hand Towel Bar











DOUX™

Pivoting Denotes pivoting paper holder

List price is per each (unless otherwise noted). Product can be ordered by case quantity or individually.

ROTHBURY® Bathroom Faucets

All Brushed Nickel faucet components feature the LifeShine® Non-Tarnish Finish.

	MODEL NUMBER	LIST PRICE	FINISH/ CONNECTION	CASE QTY
ONE-HANDLE BATHROOM FAUCET				
 <ul style="list-style-type: none"> • application: one or three hole • supply line length: flexible • connection size: 3/8" • connection type: compression • deck plate: included • drain assembly: metal • drain assembly type: spring loaded pop-up   DURALAST™	S6202	422.25	Chrome	3
	S6202BN	674.60	Brushed Nickel	3
	S6202ORB	674.60	Oil Rubbed Bronze	3
 <ul style="list-style-type: none"> • description: vessel extension kit • includes: two 3" extensions • includes: parts to convert to grid drain 	A1616	138.45	Chrome	6
	A1616BN	224.65	Brushed Nickel	6
	A1616ORB	224.65	Oil Rubbed Bronze	6
TWO-HANDLE WIDESPREAD BATHROOM FAUCET				
 <ul style="list-style-type: none"> • application: three hole • centre dimensions: 8" - 16" centre • drain assembly: metal • drain assembly type: lift rod • valve sold separately   	TS6205	398.15	Chrome	3
	TS6205BN	657.05	Brushed Nickel	3
	TS6205ORB	657.05	Oil Rubbed Bronze	3
 <ul style="list-style-type: none"> • application: three hole • centre dimensions: 8" - 16" centre • drain assembly: metal • drain assembly type: lift rod  DURALOCK™ DURALAST™	9000	148.70	1/2" IPS	6



HOW TO ORDER A COMPLETE BATHROOM FAUCET

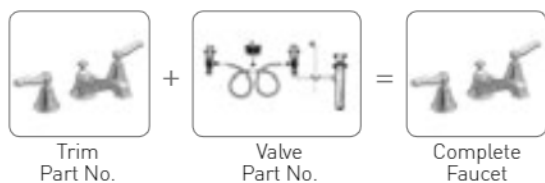







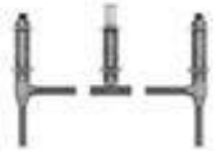

NOTES

-  Moen® **M•PACT®** Common Valve System
- DURALOCK™** Duralock™ Quick Connections
- DURALAST™** Duralast® Cartridge

ROTHBURY® Roman Tubs

All Brushed Nickel faucet components feature the LifeShine® Non-Tarnish Finish.

	MODEL NUMBER	LIST PRICE	FINISH/ CONNECTION	CASE QTY
TWO-HANDLE ROMAN TUB				
 <ul style="list-style-type: none"> • application: three hole • spout reach: 8.14" • valve sold separately 	TS923	564.25	Chrome	3
	TS923BN	829.10	Brushed Nickel	3
	TS923ORB	829.10	Oil Rubbed Bronze	3
 <ul style="list-style-type: none"> • application: three hole • deck thickness: 1/8" to 3-3/8" rough deck • centre dimensions: adjustable • adjustable spout shank: included • test plug: included 	4792	188.00	1/2" CC	6
 <ul style="list-style-type: none"> • application: three hole • deck thickness: 1/8" to 1-7/8" deck • centre dimensions: 10" centre • non-adjustable spout shank: included • test plug: included 	4796	179.95	1/2" CC	6
	4798	179.95	1/2" PEX, Cold Expansion PEX	6
 <ul style="list-style-type: none"> • description: high flow thermostatic mixing valve • 1/2" FNPT (3/8" compression adapters) • listed to ASSE Standard 1070 • max. flow rate at 45 psi = 10 gpm • tub application 	104465	223.55	1/2" FNPT	12
 <ul style="list-style-type: none"> • description: PEX transition fittings (2) and clips • adapts standard 1/2" PEX barb to 1/2" PEX cold expansion connections 	140715	11.35	1/2" PEX	200

ROTHBURY®

HOW TO ORDER A COMPLETE ROMAN TUB FAUCET

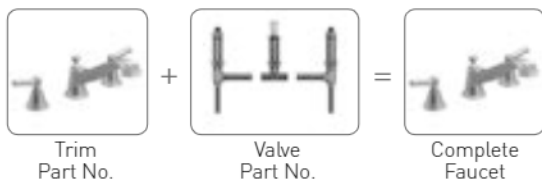







NOTES

 Moen® **M•PACT®** Common Valve System

ROTHBURY® Roman Tubs

All Brushed Nickel faucet components feature the LifeShine® Non-Tarnish Finish.

	MODEL NUMBER	LIST PRICE	FINISH/ CONNECTION	CASE QTY
TWO-HANDLE ROMAN TUB WITH HANDSHOWER				
 <ul style="list-style-type: none"> • application: four hole • showerhead type: handshower • handshower functions: one-function • handshower flow rate: 1.75 gpm (6.65 L/min) max. • spout reach: 8.14" • valve sold separately 	TS925	911.90	Chrome	3
	TS925BN	1,391.90	Brushed Nickel	3
	TS925ORB	1,391.90	Oil Rubbed Bronze	3
				
 <ul style="list-style-type: none"> • application: four hole • deck thickness: 1/8" to 2-5/8" deck • centre dimensions: 10" centre • non-adjustable spout shank: included • test plug: included 	9796	358.95	1/2" CC	6
	9797	358.95	1/2" CPVC, PEX	6
				
 <ul style="list-style-type: none"> • description: high flow thermostatic mixing valve • 1/2" FNPT (3/8" compression adapters) • listed to ASSE Standard 1070 • max. flow rate at 45 psi = 10 gpm • tub application 	104465	223.55	1/2" FNPT	12
 <ul style="list-style-type: none"> • description: PEX transition fittings (2) and clips • adapts standard 1/2" PEX barb to 1/2" PEX cold expansion connections 	140715	11.35	1/2" PEX	200



HOW TO ORDER A COMPLETE ROMAN TUB FAUCET

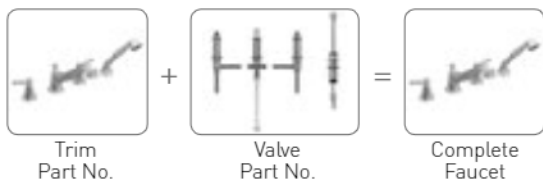











NOTES

 Moen® **M•PACT®** Common Valve System

ROTHBURY® 3/4" Thermostatic Showering

All Brushed Nickel faucet components feature the LifeShine® Non-Tarnish Finish.

		MODEL NUMBER	LIST PRICE	FINISH/ CONNECTION	CASE QTY
EXACTTEMP® VALVE TRIM					
 <ul style="list-style-type: none"> valve sold separately  		TS3760	303.50	Chrome	3
		TS3760BN	490.85	Brushed Nickel	3
		TS3760ORB	490.85	Oil Rubbed Bronze	3
 <ul style="list-style-type: none"> ports: four adjustable temperature limit stop: included check stops: included requires: separate volume control valve 		S3371	626.05	3/4" IPS	6
	VOLUME CONTROL VALVE TRIM				
 <ul style="list-style-type: none"> valve sold separately  		TS3820	136.45	Chrome	6
		TS3820BN	220.05	Brushed Nickel	6
		TS3820ORB	220.05	Oil Rubbed Bronze	6
 <ul style="list-style-type: none"> description: volume control valve 		S3600	141.15	3/4" IPS	12

ROTHBURY®

HOW TO ORDER A COMPLETE SHOWER FAUCET

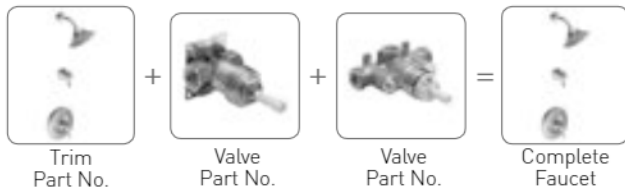







NOTES

 Moen® **M•PACT**® Common Valve System

ROTHBURY® Transfer Valve Shower Spa Components

All Brushed Nickel faucet components feature the LifeShine® Non-Tarnish Finish.

		MODEL NUMBER	LIST PRICE	FINISH/ CONNECTION	CASE QTY
TRANSFER VALVE TRIM					
 <ul style="list-style-type: none"> valve sold separately  		TS5205	147.60	Chrome	6
		TS5205BN	222.70	Brushed Nickel	6
		TS5205ORB	222.70	Oil Rubbed Bronze	6
 <ul style="list-style-type: none"> type of function: two independent one shared must be used with: Posi-Temp or Moentrol valve 		3372	188.30	1/2" CC	12
		3375	188.30	1/2" CC	12
 <ul style="list-style-type: none"> type of function: two discrete must be used with: Posi-Temp or Moentrol valve 					



HOW TO ORDER A COMPLETE TRANSFER VALVE









NOTES

 Moen® **M•PACT®** Common Valve System

ROTHBURY® Moentrol® Transfer Valve Components

All Brushed Nickel faucet components feature the LifeShine® Non-Tarnish Finish.

		MODEL NUMBER	LIST PRICE	FINISH/ CONNECTION	CASE QTY
MOENTROL® WITH TRANSFER VALVE TRIM					
 <ul style="list-style-type: none"> valve sold separately  		TS4211	240.15	Chrome	3
		TS4211BN	359.85	Brushed Nickel	3
		TS4211ORB	359.85	Oil Rubbed Bronze	3
 <ul style="list-style-type: none"> ports: four; two outlets type of function: two discrete one shared adjustable temperature limit stop: included not recommended: for tub spout application includes: volume control check stops: included 		3320	352.60	1/2" IPS/CC	6
		3330	352.60	1/2" CC	6
 <ul style="list-style-type: none"> ports: four; two outlets type of function: two discrete adjustable temperature limit stop: included not recommended: for tub spout application includes: volume control check stops: included 		3350	352.60	1/2" CC	6

ROTHBURY®

HOW TO ORDER A COMPLETE MOENTROL WITH TRANSFER VALVE















NOTES

 Moen® M•PACT® Common Valve System

ROTHBURY® Moentrol® Showering

All Brushed Nickel faucet components feature the LifeShine® Non-Tarnish Finish.

		MODEL NUMBER	LIST PRICE	FINISH/ CONNECTION	CASE QTY
MOENTROL® TUB/SHOWER					
	<ul style="list-style-type: none"> • showerhead functions: one-function • showerhead type: standard • showerhead size: 6-1/2" diameter spray head • showerhead flow rate: 2.5 gpm (9.5 L/min) max. • spout length: 7 5/8" • spout connection type: slip fit • tub spout type: diverter • valve sold separately 	TS3213	386.80	Chrome	3
		TS3213BN	711.40	Brushed Nickel	3
		TS3213ORB	711.40	Oil Rubbed Bronze	3
					
	<ul style="list-style-type: none"> • ports: four • adjustable temperature limit stop: included • includes: volume control 	3510	210.05	1/2" IPS	6
		3520	210.05	1/2" CC	6
					
	<ul style="list-style-type: none"> • ports: four • adjustable temperature limit stop: included • includes: volume control • check stops: included 	3570	232.40	1/2" CC	6
					
MOENTROL® SHOWER ONLY					
	<ul style="list-style-type: none"> • showerhead functions: one-function • showerhead type: standard • showerhead size: 6-1/2" diameter spray head • showerhead flow rate: 2.5 gpm (9.5 L/min) max. • valve sold separately 	TS3212	268.65	Chrome	3
		TS3212BN	578.85	Brushed Nickel	3
		TS3212ORB	578.85	Oil Rubbed Bronze	3
					
	<ul style="list-style-type: none"> • ports: four • adjustable temperature limit stop: included • includes: volume control 	3510	210.05	1/2" IPS	6
		3520	210.05	1/2" CC	6
					
	<ul style="list-style-type: none"> • ports: four • adjustable temperature limit stop: included • includes: volume control • check stops: included 	3570	232.40	1/2" CC	6
					



HOW TO ORDER A COMPLETE SHOWERING FAUCET







NOTES

 Moen® **M•PACT®** Common Valve System

ROTHBURY® Moentrol® Showering

All Brushed Nickel faucet components feature the LifeShine® Non-Tarnish Finish.

		MODEL NUMBER	LIST PRICE	FINISH/ CONNECTION	CASE QTY
MOENTROL® VALVE TRIM					
 <ul style="list-style-type: none"> valve sold separately 		TS3211	191.90	Chrome	3
		TS3211BN	438.20	Brushed Nickel	3
		TS3211ORB	438.20	Oil Rubbed Bronze	3
					
 <ul style="list-style-type: none"> ports: four adjustable temperature limit stop: included includes: volume control 		3510	210.05	1/2" IPS	6
		3520	210.05	1/2" CC	6
					
 <ul style="list-style-type: none"> ports: four adjustable temperature limit stop: included includes: volume control check stops: included 		3570	232.40	1/2" CC	6
					

ROTHBURY®

HOW TO ORDER A COMPLETE VALVE











NOTES

 Moen® **M•PACT®** Common Valve System

ROTHBURY® Posi-Temp® Showering

All Brushed Nickel faucet components feature the LifeShine® Non-Tarnish Finish.

		MODEL NUMBER	LIST PRICE	FINISH/ CONNECTION	CASE QTY
POSI-TEMP® TUB/SHOWER					
	<ul style="list-style-type: none"> • showerhead functions: one-function • showerhead type: standard • showerhead size: 6-1/2" diameter spray head • showerhead flow rate: 2.5 gpm (9.5 L/min) max. • spout length: 7 5/8" • spout connection type: slip fit • tub spout type: diverter • valve sold separately 	TS2213	322.50	Chrome	3
		TS2213BN	544.75	Brushed Nickel	3
		TS2213ORB	544.75	Oil Rubbed Bronze	3
					
	<ul style="list-style-type: none"> • showerhead functions: one-function • showerhead type: eco-performance showerhead • showerhead size: 6-1/2" diameter spray head • showerhead flow rate: 1.75 gpm (6.65 L/min) max. • spout length: 7 5/8" • spout connection type: slip fit • tub spout type: diverter • valve sold separately 	TS2213EP	322.50	Chrome	3
		TS2213EPBN	544.75	Brushed Nickel	3
		TS2213EPORB	544.75	Oil Rubbed Bronze	3
					
	<ul style="list-style-type: none"> • ports: four • adjustable temperature limit stop: included 	2510	152.20	1/2" IPS	6
		2520	152.20	1/2" CC	6
					
	<ul style="list-style-type: none"> • ports: four • adjustable temperature limit stop: included • quarter turn stops: included 	2570	194.75	1/2" CC	6
		2590	194.75	1/2" IPS	6
					



HOW TO ORDER A COMPLETE TUB/SHOWER FAUCET











NOTES

 Moen® **M•PACT®** Common Valve System

ROTHBURY® Posi-Temp® Showering

All Brushed Nickel faucet components feature the LifeShine® Non-Tarnish Finish.

		MODEL NUMBER	LIST PRICE	FINISH/ CONNECTION	CASE QTY
POSI-TEMP® SHOWER ONLY					
	<ul style="list-style-type: none"> • showerhead functions: one-function • showerhead type: standard • showerhead size: 6-1/2" diameter spray head • showerhead flow rate: 2.5 gpm (9.5 L/min) max. • valve sold separately 	TS2212	251.80	Chrome	3
		TS2212BN	430.70	Brushed Nickel	3
		TS2212ORB	430.70	Oil Rubbed Bronze	3
					
	<ul style="list-style-type: none"> • showerhead functions: one-function • showerhead type: eco-performance showerhead • showerhead size: 6-1/2" diameter spray head • showerhead flow rate: 1.75 gpm (6.65 L/min) max. • valve sold separately 	TS2212EP	251.80	Chrome	3
		TS2212EPBN	430.70	Brushed Nickel	3
		TS2212EPORB	430.70	Oil Rubbed Bronze	3
					
	<ul style="list-style-type: none"> • ports: four • adjustable temperature limit stop: included 	2510	152.20	1/2" IPS	6
		2520	152.20	1/2" CC	6
					
	<ul style="list-style-type: none"> • ports: four • adjustable temperature limit stop: included • quarter turn stops: included 	2570	194.75	1/2" CC	6
		2590	194.75	1/2" IPS	6
					

ROTHBURY®

HOW TO ORDER A COMPLETE SHOWER FAUCET









NOTES

 Moen® **M•PACT®** Common Valve System

ROTHBURY® Posi-Temp® Showering

All Brushed Nickel faucet components feature the LifeShine® Non-Tarnish Finish.

		MODEL NUMBER	LIST PRICE	FINISH/ CONNECTION	CASE QTY
POSI-TEMP® VALVE TRIM					
 <ul style="list-style-type: none"> valve sold separately 		TS2211	172.00	Chrome	3
		TS2211BN	321.60	Brushed Nickel	3
		TS2211ORB	321.60	Oil Rubbed Bronze	3
					
 <ul style="list-style-type: none"> ports: four adjustable temperature limit stop: included 		2510	152.20	1/2" IPS	6
		2520	152.20	1/2" CC	6
					
 <ul style="list-style-type: none"> ports: four adjustable temperature limit stop: included quarter turn stops: included 		2570	194.75	1/2" CC	6
		2590	194.75	1/2" IPS	6
					



HOW TO ORDER A COMPLETE VALVE



NOTES

 Moen® **M•PACT®** Common Valve System

ROTHBURY® Perfectly Matched Bath Accessories

Moen® makes it easy to coordinate the entire style and look of the bathroom. Our Rothbury® bath accessories perfectly match the style and finish of our Rothbury faucets. Total coordination of the bath has never been easier.

MODEL NUMBER	LIST PRICE EACH	DESCRIPTION	QTY
Chrome (CH)			
YB8201CH	65.55	Toilet Tank Lever	24
YB8203CH	58.30	Double Robe Hook	24
YB8205CH	11.50	Cabinet Knob	48
YB8207CH	23.00	Drawer Pull	48
<i>Pivoting</i> YB8208CH	110.50	Pivoting Paper Holder	6
YB8218CH	123.70	18" Towel Bar	6
YB8224CH	127.60	24" Towel Bar	6
YB8286CH	81.80	Mini Towel Bar	6
Brushed Nickel (BN)			
YB8201BN	75.10	Toilet Tank Lever	24
YB8203BN	66.30	Double Robe Hook	24
YB8205BN	13.35	Cabinet Knob	48
YB8207BN	24.80	Drawer Pull	48
<i>Pivoting</i> YB8208BN	121.85	Pivoting Paper Holder	6
YB8218BN	140.25	18" Towel Bar	6
YB8224BN	145.60	24" Towel Bar	6
YB8286BN	86.85	Mini Towel Bar	6
Oil Rubbed Bronze (ORB)			
YB8201ORB	75.10	Toilet Tank Lever	24
YB8203ORB	66.30	Double Robe Hook	24
YB8205ORB	14.50	Cabinet Knob	48
YB8207ORB	26.90	Drawer Pull	48
<i>Pivoting</i> YB8208ORB	121.85	Pivoting Paper Holder	6
YB8218ORB	140.25	18" Towel Bar	6
YB8224ORB	145.60	24" Towel Bar	6
YB8286ORB	86.85	Mini Towel Bar	6



YB8201 Toilet Tank Lever



YB8203 Double Robe Hook



YB8205 Cabinet Knob



YB8207 Drawer Pull



YB8208 *Pivoting* Pivoting Paper Holder



YB8218 18" Towel Bar



YB8286 Mini Towel Bar



YB8224 24" Towel Bar

ROTHBURY®

ROTHBURY® Perfectly Matched Bath Accessories



ROTHBURY®

LIGHTING

MODEL NUMBER	LIST PRICE EACH	DESCRIPTION	QTY
Chrome (CH)			
YB8261CH	164.80	One-Globe Light	2
YB8262CH	230.70	Two-Globe Light	3
YB8263CH	253.45	Three-Globe Light	2
Brushed Nickel (BN)			
YB8261BN	206.00	One-Globe Light	2
YB8262BN	288.25	Two-Globe Light	3
YB8263BN	316.85	Three-Globe Light	2
Oil Rubbed Bronze (ORB)			
YB8261ORB	206.00	One-Globe Light	2
YB8262ORB	288.25	Two-Globe Light	2
YB8263ORB	316.85	Three-Globe Light	2
Replacement Globe			
YB8269	29.40	Replacement Globe Service Kit	3



YB8261
One-Globe Light



YB8262
Two-Globe Light



YB8263
Three-Globe Light



YB8269
Replacement Globe





Bulbs not included.



All lighting fixtures can be mounted facing either upward or downward (rings need to be removed if mounted up).

ICON™ Bathroom Faucets

All Brushed Nickel faucet components feature the LifeShine® Non-Tarnish Finish.

	MODEL NUMBER	LIST PRICE	FINISH/ CONNECTION	CASE QTY
ONE-HANDLE BATHROOM FAUCET				
 <ul style="list-style-type: none"> • application: one or three hole • supply line length: flexible • connection size: 3/8" • connection type: compression • deck plate: included • drain assembly: metal • drain assembly type: lift rod 	S6500	357.05	Chrome	3
	S6500BN	584.20	Brushed Nickel	3
 <ul style="list-style-type: none"> • description: vessel extension kit • includes: two 2.5 extensions • includes: parts to convert to grid drain 	A1717	138.45	Chrome	6
	A1717BN	224.65	Brushed Nickel	6

TWO-HANDLE BATHROOM FAUCET				
 <ul style="list-style-type: none"> • application: three hole • centre dimensions: 4" centre • connection size: 1/2" • connection type: IPS • drain assembly: metal • drain assembly type: lift rod 	S6510	343.15	Chrome	3
	S6510BN	542.05	Brushed Nickel	3

TWO-HANDLE WIDESPREAD BATHROOM FAUCET				
 <ul style="list-style-type: none"> • application: three hole • centre dimensions: 8" - 16" centre • drain assembly: metal • drain assembly type: lift rod • valve sold separately 	TS6520	385.45	Chrome	3
	TS6520BN	610.65	Brushed Nickel	3
 <ul style="list-style-type: none"> • application: three hole • centre dimensions: 8" - 16" centre • drain assembly: metal • drain assembly type: lift rod 	9000	148.70	1/2" IPS	6

HOW TO ORDER A COMPLETE BATHROOM FAUCET

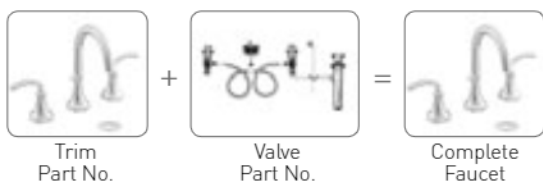









NOTES

-  Moen® **M•PACT**® Common Valve System
- DURALOCK** Duralock™ Quick Connections
- DURALAST** Duralast® Cartridge

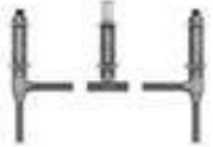

ICON™ Roman Tubs

All Brushed Nickel faucet components feature the LifeShine® Non-Tarnish Finish.

	MODEL NUMBER	LIST PRICE	FINISH/ CONNECTION	CASE QTY
TWO-HANDLE ROMAN TUB				
 <ul style="list-style-type: none"> • application: three hole • spout reach: 7.88" • valve sold separately 	TS963	452.20	Chrome	3
	TS963BN	697.40	Brushed Nickel	3
 <ul style="list-style-type: none"> • application: three hole • deck thickness: 1/8" to 3-3/8" rough deck • centre dimensions: adjustable • adjustable spout shank: included • test plug: included 	4792	188.00	1/2" CC	6
 <ul style="list-style-type: none"> • application: three hole • deck thickness: 1/8" to 1-7/8" deck • centre dimensions: 10" centre • non-adjustable spout shank: included • test plug: included 	4796	179.95	1/2" CC	6
	4798	179.95	1/2" PEX, Cold Expansion PEX	6
 <ul style="list-style-type: none"> • description: high flow thermostatic mixing valve • 1/2" FNPT (3/8" compression adapters) • listed to ASSE Standard 1070 • max. flow rate at 45 psi = 10 gpm • tub application 	104465	223.55	1/2" FNPT	12
 <ul style="list-style-type: none"> • description: PEX transition fittings (2) and clips • adapts standard 1/2" PEX barb to 1/2" PEX cold expansion connections 	140715	11.35	1/2" PEX	200

ICON™

HOW TO ORDER A COMPLETE ROMAN TUB FAUCET

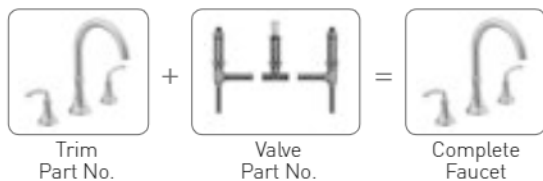







NOTES

 Moen® **M•PACT®** Common Valve System

ICON™ Roman Tub

All Brushed Nickel faucet components feature the LifeShine® Non-Tarnish Finish.

	MODEL NUMBER	LIST PRICE	FINISH/ CONNECTION	CASE QTY
TWO-HANDLE ROMAN TUB WITH HANDSHOWER				
 <ul style="list-style-type: none"> • application: four hole • showerhead type: handshower • handshower functions: one-function • handshower flow rate: 1.75 gpm (6.65 L/min) max. • spout reach: 7.88" • valve sold separately 	TS964	719.35	Chrome	3
	TS964BN	1,167.75	Brushed Nickel	3
 <ul style="list-style-type: none"> • application: four hole • deck thickness: 1/8" to 2-5/8" deck • centre dimensions: 10" centre • non-adjustable spout shank: included • test plug: included 	9796	358.95	1/2" CC	6
	9797	358.95	1/2" CPVC, PEX	6
 <ul style="list-style-type: none"> • description: high flow thermostatic mixing valve • 1/2" FNPT (3/8" compression adapters) • listed to ASSE Standard 1070 • max. flow rate at 45 psi = 10 gpm • tub application 	104465	223.55	1/2" FNPT	12
 <ul style="list-style-type: none"> • description: PEX transition fittings (2) and clips • adapts standard 1/2" PEX barb to 1/2" PEX cold expansion connections 	140715	11.35	1/2" PEX	200



HOW TO ORDER A COMPLETE ROMAN TUB FAUCET

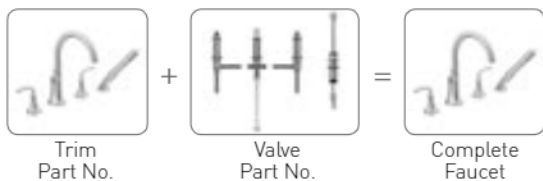











NOTES

 Moen® **M•PACT**® Common Valve System

ICON™ 3/4" Thermostatic Showering

All Brushed Nickel faucet components feature the LifeShine® Non-Tarnish Finish.

		MODEL NUMBER	LIST PRICE	FINISH/ CONNECTION	CASE QTY
EXACTTEMP® VALVE TRIM					
 <ul style="list-style-type: none"> valve sold separately  		TS3900	290.80	Chrome	3
		TS3900BN	485.65	Brushed Nickel	3
 <ul style="list-style-type: none"> ports: four adjustable temperature limit stop: included check stops: included requires: separate volume control valve 		S3371	626.05	3/4" IPS	6
VOLUME CONTROL VALVE TRIM					
 <ul style="list-style-type: none"> valve sold separately  		TS3200	134.40	Chrome	6
		TS3200BN	218.85	Brushed Nickel	6
 <ul style="list-style-type: none"> description: volume control valve 		S3600	141.15	3/4" IPS	12

ICON™

HOW TO ORDER A COMPLETE SHOWER FAUCET

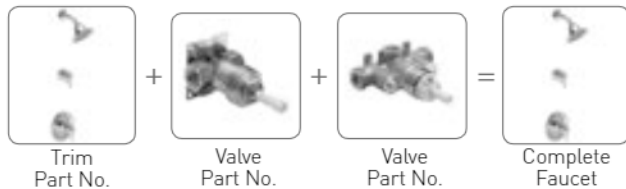







NOTES

 Moen® M•PACT® Common Valve System

ICON™ Moentrol® Transfer Valve Shower Spa Components

All Brushed Nickel faucet components feature the LifeShine® Non-Tarnish Finish.

		MODEL NUMBER	LIST PRICE	FINISH/ CONNECTION	CASE QTY
MOENTROL® WITH TRANSFER VALVE TRIM					
 <ul style="list-style-type: none"> valve sold separately  		TS4112	229.75	Chrome	3
		TS4112BN	343.30	Brushed Nickel	3
 <ul style="list-style-type: none"> ports: four; two outlets type of function: two discrete one shared adjustable temperature limit stop: included not recommended: for tub spout application includes: volume control check stops: included 		3320	352.60	1/2" IPS/CC	6
		3330	352.60	1/2" CC	6
 <ul style="list-style-type: none"> ports: four; two outlets type of function: two discrete adjustable temperature limit stop: included not recommended: for tub spout application includes: volume control check stops: included 		3350	352.60	1/2" CC	6



HOW TO ORDER A COMPLETE MOENTROL WITH TRANSFER VALVE









NOTES

 Moen® **M•PACT®** Common Valve System

ICON™ Moentrol® Showering

All Brushed Nickel faucet components feature the LifeShine® Non-Tarnish Finish.

		MODEL NUMBER	LIST PRICE	FINISH/ CONNECTION	CASE QTY
MOENTROL® TUB/SHOWER					
	<ul style="list-style-type: none"> • showerhead functions: one-function • showerhead type: standard • showerhead size: 5-7/8" diameter spray head • showerhead flow rate: 2.5 gpm (9.5 L/min) max. • spout length: 7 1/4" • spout connection type: slip fit • tub spout type: diverter • valve sold separately 	TS2156	350.70	Chrome	3
		TS2156BN	609.45	Brushed Nickel	3
	<ul style="list-style-type: none"> • ports: four • adjustable temperature limit stop: included • includes: volume control 	3510	210.05	1/2" IPS	6
		3520	210.05	1/2" CC	6
	<ul style="list-style-type: none"> • ports: four • adjustable temperature limit stop: included • includes: volume control • check stops: included 	3570	232.40	1/2" CC	6
MOENTROL® SHOWER ONLY					
	<ul style="list-style-type: none"> • showerhead functions: one-function • showerhead type: standard • showerhead size: 5-7/8" diameter spray head • showerhead flow rate: 2.5 gpm (9.5 L/min) max. • valve sold separately 	TS2155	243.80	Chrome	3
		TS2155BN	496.45	Brushed Nickel	3
	<ul style="list-style-type: none"> • ports: four • adjustable temperature limit stop: included • includes: volume control 	3510	210.05	1/2" IPS	6
		3520	210.05	1/2" CC	6
	<ul style="list-style-type: none"> • ports: four • adjustable temperature limit stop: included • includes: volume control • check stops: included 	3570	232.40	1/2" CC	6

ICON™

HOW TO ORDER A COMPLETE SHOWERING FAUCET





NOTES

 Moen® **M•PACT®** Common Valve System

ICON™ Moentrol® Showering

All Brushed Nickel faucet components feature the LifeShine® Non-Tarnish Finish.

		MODEL NUMBER	LIST PRICE	FINISH/ CONNECTION	CASE QTY
MOENTROL® VALVE TRIM					
 <ul style="list-style-type: none"> valve sold separately 		TS2154	174.45	Chrome	3
		TS2154BN	375.80	Brushed Nickel	3
 <ul style="list-style-type: none"> ports: four adjustable temperature limit stop: included includes: volume control 		3510	210.05	1/2" IPS	6
		3520	210.05	1/2" CC	6
 <ul style="list-style-type: none"> ports: four adjustable temperature limit stop: included includes: volume control check stops: included 		3570	232.40	1/2" CC	6



HOW TO ORDER A COMPLETE VALVE











NOTES

 Moen® **M•PACT®** Common Valve System

ICON™ Posi-Temp® Showering

All Brushed Nickel faucet components feature the LifeShine® Non-Tarnish Finish.

		MODEL NUMBER	LIST PRICE	FINISH/ CONNECTION	CASE QTY
POSI-TEMP® TUB/SHOWER					
	<ul style="list-style-type: none"> • showerhead functions: one-function • showerhead type: standard • showerhead size: 5-7/8" diameter spray head • showerhead flow rate: 2.5 gpm (9.5 L/min) max. • spout length: 7 1/4" • spout connection type: slip fit • tub spout type: diverter • valve sold separately 	TS2143	291.20	Chrome	3
		TS2143BN	478.25	Brushed Nickel	3
					
	<ul style="list-style-type: none"> • showerhead functions: one-function • showerhead type: eco-performance showerhead • showerhead size: 5-7/8" diameter spray head • showerhead flow rate: 1.75 gpm (6.65 L/min) max. • spout length: 7 1/4" • spout connection type: slip fit • tub spout type: diverter • valve sold separately 	TS2143EP	291.20	Chrome	3
		TS2143EPBN	478.25	Brushed Nickel	3
					
	<ul style="list-style-type: none"> • ports: four • adjustable temperature limit stop: included 	2510	152.20	1/2" IPS	6
		2520	152.20	1/2" CC	6
					
	<ul style="list-style-type: none"> • ports: four • adjustable temperature limit stop: included • quarter turn stops: included 	2570	194.75	1/2" CC	6
		2590	194.75	1/2" IPS	6
					

ICON™

HOW TO ORDER A COMPLETE TUB/SHOWER FAUCET











NOTES

 Moen® **M•PACT®** Common Valve System

ICON™ Posi-Temp® Showering

All Brushed Nickel faucet components feature the LifeShine® Non-Tarnish Finish.

		MODEL NUMBER	LIST PRICE	FINISH/ CONNECTION	CASE QTY
POSI-TEMP® SHOWER ONLY					
	<ul style="list-style-type: none"> • showerhead functions: one-function • showerhead type: standard • showerhead size: 5-7/8" diameter spray head • showerhead flow rate: 2.5 gpm (9.5 L/min) max. • valve sold separately 	TS2142	227.60	Chrome	3
		TS2142BN	389.20	Brushed Nickel	3
					
	<ul style="list-style-type: none"> • showerhead functions: one-function • showerhead type: eco-performance showerhead • showerhead size: 5-7/8" diameter spray head • showerhead flow rate: 1.75 gpm (6.65 L/min) max. • valve sold separately 	TS2142EP	227.60	Chrome	3
		TS2142EPBN	389.20	Brushed Nickel	3
					
	<ul style="list-style-type: none"> • ports: four • adjustable temperature limit stop: included 	2510	152.20	1/2" IPS	6
		2520	152.20	1/2" CC	6
					
	<ul style="list-style-type: none"> • ports: four • adjustable temperature limit stop: included • quarter turn stops: included 	2570	194.75	1/2" CC	6
		2590	194.75	1/2" IPS	6
					



HOW TO ORDER A COMPLETE SHOWER FAUCET





NOTES

 Moen® **M•PACT®** Common Valve System

ICON™ Posi-Temp® Showering

All Brushed Nickel faucet components feature the LifeShine® Non-Tarnish Finish.

		MODEL NUMBER	LIST PRICE	FINISH/ CONNECTION	CASE QTY
POSI-TEMP® VALVE TRIM					
 <ul style="list-style-type: none"> • valve sold separately 		TS2141	155.55	Chrome	3
		TS2141BN	291.05	Brushed Nickel	3
 <ul style="list-style-type: none"> • ports: four • adjustable temperature limit stop: included 		2510	152.20	1/2" IPS	6
		2520	152.20	1/2" CC	6
 <ul style="list-style-type: none"> • ports: four • adjustable temperature limit stop: included • quarter turn stops: included 		2570	194.75	1/2" CC	6
		2590	194.75	1/2" IPS	6

ICON™



HOW TO ORDER A COMPLETE VALVE



NOTES

 Moen® **M•PACT®** Common Valve System

Moen® makes it easy to coordinate the entire style and look of the bathroom. Our Icon™ bath accessories perfectly match the style and finish of our Icon faucets. Total coordination of the bath has never been easier.

MODEL NUMBER	LIST PRICE EACH	DESCRIPTION	QTY
Chrome (CH)			
YB5801CH	44.60	Toilet Tank Lever	24
YB5803CH	43.65	Double Robe Hook	24
YB5805CH	9.80	Cabinet Knob	48
YB5807CH	19.35	Drawer Pull	48
 YB5808CH	82.65	Pivoting Paper Holder	6
YB5818CH	92.60	18" Towel Bar	6
YB5822CH	123.00	24" Double Towel Bar	6
YB5824CH	95.40	24" Towel Bar	6
YB5886CH	64.90	Towel Ring	6
YB5890CH	134.50	Glass Shelf (20.3"W x 5.6"D x 3.4"H)	6
Brushed Nickel (BN)			
YB5801BN	54.15	Toilet Tank Lever	6
YB5803BN	49.50	Double Robe Hook	24
YB5805BN	12.75	Cabinet Knob	48
YB5807BN	23.55	Drawer Pull	48
 YB5808BN	91.10	Pivoting Paper Holder	6
YB5818BN	104.95	18" Towel Bar	6
YB5822BN	136.70	24" Double Towel Bar	6
YB5824BN	108.95	24" Towel Bar	6
YB5886BN	73.40	Towel Ring	6
YB5890BN	150.15	Glass Shelf (20.3"W x 5.6"D x 3.4"H)	6
Miscellaneous			
YB8081	16.30	Pro-Fit® Installation Mounting Template	25



YB5801
Toilet Tank Lever



YB5803
Double Robe Hook



YB5805
Cabinet Knob



YB5807
Drawer Pull



YB5808 
Pivoting Paper Holder



YB5818
18" Towel Bar



YB5822
24" Double Towel Bar



YB5824
24" Towel Bar



YB5886
Towel Ring

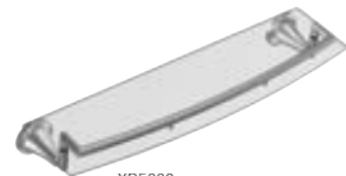











YB5890
Glass Shelf



YB8081
Pro-Fit® Installation Mounting Template (See page 54 for more information about the Pro-Fit® Installation System).

WYNFORD™ Bathroom Faucets

All Brushed Nickel and Polished Nickel faucet components feature the LifeShine® Non-Tarnish Finish.

		MODEL NUMBER	LIST PRICE	FINISH/ CONNECTION	CASE QTY
ONE-HANDLE BATHROOM FAUCET					
  <ul style="list-style-type: none"> • application: one or three hole • supply line length: flexible • connection size: 3/8" • connection type: compression • deckplate: included • drain assembly: metal • drain assembly type: lift rod   <p>DURALAST*</p>		4500	326.50	Chrome	3
		4500BN	539.50	Brushed Nickel	3
		4500NL	539.50	Polished Nickel	3
		4500ORB	539.50	Oil Rubbed Bronze	3
 <ul style="list-style-type: none"> • application: one hole • supply line length: flexible • connection size: 3/8" • connection type: compression • drain assembly: 140780 sold separately   <p>DURALAST*</p>		4507	457.15	Chrome	3
		4507BN	728.40	Brushed Nickel	3
		4507ORB	728.40	Oil Rubbed Bronze	3
 <ul style="list-style-type: none"> • drain assembly: metal • drain assembly type: spring loaded pop-up • drain assembly size: 1-1/4" • drain assembly: 1-1/4" non-overflow 		140780	94.40	Chrome	12
		140780BN	136.05	Brushed Nickel	12
		140780ORB	136.05	Oil Rubbed Bronze	12
TWO-HANDLE CENTERSET BATHROOM FAUCET					
 <ul style="list-style-type: none"> • application: three hole • center dimensions: 4" center • connection size: 1/2" • connection type: IPS • drain assembly: metal • drain assembly type: lift rod  		4505	313.80	Chrome	3
		4505BN	500.60	Brushed Nickel	3
		4505NL	500.60	Polished Nickel	3
		4505ORB	500.60	Oil Rubbed Bronze	3









WYNFORD™

NOTES

DURALAST® Duralast® Cartridge

WYNFORD™ Bathroom Faucets

All Brushed Nickel and Polished Nickel faucet components feature the LifeShine® Non-Tarnish Finish.

	MODEL NUMBER	LIST PRICE	FINISH/ CONNECTION	CASE QTY
TWO-HANDLE WIDESPREAD BATHROOM FAUCET				
 <ul style="list-style-type: none"> • application: three hole • centre dimensions: 8" - 16" centre • drain assembly: metal • drain assembly type: lift rod • valve sold separately   	T4520	352.45	Chrome	3
	T4520BN	564.05	Brushed Nickel	3
	T4520NL	564.05	Polished Nickel	3
	T4520ORB	564.05	Oil Rubbed Bronze	3
 <ul style="list-style-type: none"> • application: three hole • centre dimensions: 8" - 16" centre • drain assembly: metal • drain assembly type: lift rod • valve sold separately  	T4524	352.45	Chrome	3
	T4524BN	564.05	Brushed Nickel	3
	T4524NL	564.05	Polished Nickel	3
	T4524ORB	564.05	Oil Rubbed Bronze	3
 <ul style="list-style-type: none"> • application: three hole • centre dimensions: 8" - 16" centre • drain assembly: metal • drain assembly type: lift rod  DURALOCK® DURALAST®	9000	148.70	1/2" IPS	6

WYNFORD™

HOW TO ORDER A COMPLETE BATHROOM FAUCET

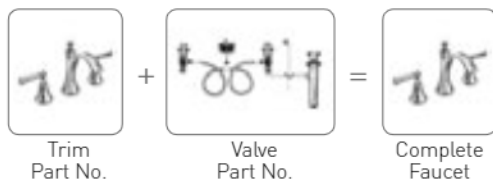





NOTES

-  Moen® **M•PACT®** Common Valve System
- DURALOCK®** Duralock™ Quick Connections
- DURALAST®** Duralast® Cartridge

WYNFORD™ Tub Fillers

All Brushed Nickel and Polished Nickel faucet components feature the LifeShine® Non-Tarnish Finish.

	MODEL NUMBER	LIST PRICE	FINISH/ CONNECTION	CASE QTY
FREESTANDING TUB FILLER				
 <ul style="list-style-type: none"> • application: one hole • showerhead type: handshower • handshower functions: one-function • handshower flow rate: 1.75 gpm (6.65 L/min) max. • spout reach: 8.75" • mounting kit: sold separately  	655	1,821.70	Chrome	1
	655BN	2,692.25	Brushed Nickel	1
	655NL	2,692.25	Polished Nickel	1
	655ORB	2,692.25	Oil Rubbed Bronze	1
 <ul style="list-style-type: none"> • description: single riser floor joist mounting kit • application: one hole • quarter turn stops: included 	TS50100	336.65	1/2" CC, NPT	2



HOW TO ORDER A COMPLETE FLOORMOUNT TUB FILLER











NOTES

 Moen® **M•PACT**® Common Valve System

WYNFORD™ Roman Tub

All Brushed Nickel and Polished Nickel faucet components feature the LifeShine® Non-Tarnish Finish.

WYNFORD™

		MODEL NUMBER	LIST PRICE	FINISH/ CONNECTION	CASE QTY
TWO-HANDLE ROMAN TUB FAUCET					
 <ul style="list-style-type: none"> • application: three hole • spout reach: 7.50" • valve sold separately 		T653	413.60	Chrome	3
		T653BN	644.10	Brushed Nickel	3
		T653NL	644.10	Polished Nickel	3
		T653ORB	644.10	Oil Rubbed Bronze	3
 <ul style="list-style-type: none"> • application: three hole • spout reach: 7.50" • valve sold separately 		T657	413.60	Chrome	3
		T657BN	644.10	Brushed Nickel	3
		T657NL	644.10	Polished Nickel	3
		T657ORB	644.10	Oil Rubbed Bronze	3
 <ul style="list-style-type: none"> • application: three hole • deck thickness: 1/8" to 3-3/8" rough deck • centre dimensions: adjustable • adjustable spout shank: included • test plug: included 		4792	188.00	1/2" CC	6
		4796 4798	179.95 179.95	1/2" CC 1/2" PEX, Cold Expansion PEX	6 6
 <ul style="list-style-type: none"> • description: high flow thermostatic mixing valve • 1/2" FNPT (3/8" compression adapters) • listed to ASSE Standard 1070 • max. flow rate at 45 psi = 10 gpm • tub application 		104465	223.55	1/2" FNPT	12
 <ul style="list-style-type: none"> • description: PEX transition fittings (2) and clips • adapts standard 1/2" PEX barb to 1/2" PEX cold expansion connections 		140715	11.35	1/2" PEX	200

HOW TO ORDER A COMPLETE ROMAN TUB FAUCET

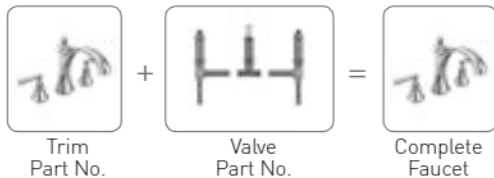









NOTES

 Moen® **M•PACT®** Common Valve System

WYNFORD™ Roman Tub

All Brushed Nickel and Polished Nickel faucet components feature the LifeShine® Non-Tarnish Finish.

	MODEL NUMBER	LIST PRICE	FINISH/ CONNECTION	CASE QTY
TWO-HANDLE ROMAN TUB FAUCET WITH HANDSHOWER				
 <ul style="list-style-type: none"> • application: four hole • showerhead type: handshower • handshower functions: one-function • handshower flow rate: 1.75 gpm (6.65 L/min) max. • spout reach: 7.5" • valve sold separately  	T654	657.90	Chrome	3
	T654BN	1,078.50	Brushed Nickel	3
	T654NL	1,078.50	Polished Nickel	3
	T654ORB	1,078.50	Oil Rubbed Bronze	3
 <ul style="list-style-type: none"> • application: four hole • showerhead type: handshower • handshower functions: one-function • handshower flow rate: 1.75 gpm (6.65 L/min) max. • spout reach: 7.5" • valve sold separately 	T658	657.90	Chrome	3
	T658BN	1,078.50	Brushed Nickel	3
	T658ORB	1,078.50	Oil Rubbed Bronze	3
 <ul style="list-style-type: none"> • application: four hole • deck thickness: 1/8" to 2-5/8" deck • centre dimensions: 10" centre • non-adjustable spout shank: included • test plug: included 	9796	358.95	1/2" CC	6
	9797	358.95	1/2" CPVC, Cold Expansion PEX	6
 <ul style="list-style-type: none"> • description: high flow thermostatic mixing valve • 1/2" FNPT (3/8" compression adapters) • listed to ASSE Standard 1070 • max. flow rate at 45 psi = 10 gpm • tub application 	104465	223.55	1/2" FNPT	12
 <ul style="list-style-type: none"> • description: PEX transition fittings (2) and clips • adapts standard 1/2" PEX barb to 1/2" PEX cold expansion connections 	140715	11.35	1/2" PEX	200



HOW TO ORDER A COMPLETE ROMAN TUB FAUCET

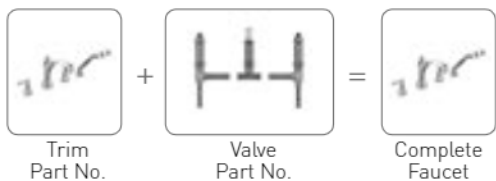









NOTES

 Moen® **M•PACT**® Common Valve System

WYNFORD™ 3/4" Thermostatic Showering

All Brushed Nickel and Polished Nickel faucet components feature the LifeShine® Non-Tarnish Finish.

	MODEL NUMBER	LIST PRICE	FINISH/ CONNECTION	CASE QTY
EXACTTEMP® VALVE ONLY				
 <ul style="list-style-type: none"> description: temperature control valve trim requires: separate volume control valve valve: sold separately 	T6601	280.00	Chrome	3
	T6601BN	472.30	Brushed Nickel	3
	T6601NL	472.30	Polished Nickel	3
	T6601ORB	472.30	Oil Rubbed Bronze	3
 <ul style="list-style-type: none"> ports: four adjustable temperature limit stop: included check stops: included requires: separate volume control valve 	S3371	626.05	3/4" IPS	6
EXACTTEMP® VOLUME CONTROL VALVE ONLY				
 <ul style="list-style-type: none"> valve: sold separately 	T6602	129.45	Chrome	6
	T6602BN	212.85	Brushed Nickel	6
	T6602NL	212.85	Polished Nickel	6
	T6602ORB	212.85	Oil Rubbed Bronze	6
 <ul style="list-style-type: none"> description: volume control rough-in valve includes: volume control 	S3600	141.15	3/4" IPS	12

WYNFORD™

HOW TO ORDER A COMPLETE EXACTTEMP® VALVE

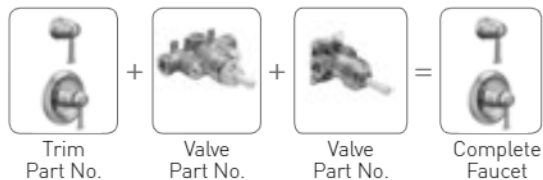

NOTES

 Moen® **M•PACT®** Common Valve System

WYNFORD™ Transfer Valve Shower Spa Components

All Brushed Nickel and Polished Nickel faucet components feature the LifeShine® Non-Tarnish Finish.

	MODEL NUMBER	LIST PRICE	FINISH/ CONNECTION	CASE QTY
3 INDEPENDENT FUNCTION TRANSFER VALVE ONLY				
 <ul style="list-style-type: none"> • use with 3362 transfer valve • valve: sold separately  	T4512	134.25	Chrome	12
	T4512BN	205.25	Brushed Nickel	12
	T4512NL	205.25	Polished Nickel	12
	T4512ORB	205.25	Oil Rubbed Bronze	12
 <ul style="list-style-type: none"> • ports: four • type of function: three independent function • must be used with: Posi-Temp® or Moentrol® valve  	3362	215.60	1/2" CC	6
TRANSFER VALVE TRIM				
 <ul style="list-style-type: none"> • valve sold separately  	T4511	128.90	Chrome	12
	T4511BN	196.20	Brushed Nickel	12
	T4511NL	196.20	Polished Nickel	12
	T4511ORB	196.20	Oil Rubbed Bronze	12
 <ul style="list-style-type: none"> • type of function: two independent one shared • must be used with: Posi-Temp or Moentrol valve 	3372	188.30	1/2" CC	12
 <ul style="list-style-type: none"> • type of function: two discrete • must be used with: Posi-Temp or Moentrol valve 	3375	188.30	1/2" CC	12



HOW TO ORDER A COMPLETE TRANSFER VALVE















NOTES

 Moen® M•PACT® Common Valve System

WYNFORD™ Moentrol® Showering

All Brushed Nickel and Polished Nickel faucet components feature the LifeShine® Non-Tarnish Finish.

		MODEL NUMBER	LIST PRICE	FINISH/ CONNECTION	CASE QTY
MOENTROL® TUB/SHOWER					
	<ul style="list-style-type: none"> • showerhead functions: one-function • showerhead type: rainshower • showerhead size: 7" diameter spray head • showerhead flow rate: 2.5 gpm (9.5 L/min) max. • spout length: 7 15/16" • spout connection type: slip fit • tub spout type: diverter • valve sold separately 	T5503	348.00	Chrome	3
		T5503BN	604.70	Brushed Nickel	3
		T5503NL	604.70	Polished Nickel	3
		T5503ORB	604.70	Oil Rubbed Bronze	3
					
	<ul style="list-style-type: none"> • ports: four • adjustable temperature limit stop: included • includes: volume control 	3510	210.05	1/2" IPS	6
		3520	210.05	1/2" CC	6
					
	<ul style="list-style-type: none"> • ports: four • adjustable temperature limit stop: included • includes: volume control • check stops: included 	3570	232.40	1/2" CC	6
					
MOENTROL® SHOWER ONLY					
	<ul style="list-style-type: none"> • showerhead functions: one-function • showerhead type: rainshower • showerhead size: 7" diameter spray head • showerhead flow rate: 2.5 gpm (9.5 L/min) max. • valve sold separately 	T5502	250.30	Chrome	3
		T5502BN	500.25	Brushed Nickel	3
		T5502NL	500.25	Polished Nickel	3
		T5502ORB	500.25	Oil Rubbed Bronze	3
					
	<ul style="list-style-type: none"> • ports: four • adjustable temperature limit stop: included • includes: volume control 	3510	210.05	1/2" IPS	6
		3520	210.05	1/2" CC	6
					
	<ul style="list-style-type: none"> • ports: four • adjustable temperature limit stop: included • includes: volume control • check stops: included 	3570	232.40	1/2" CC	6
					

HOW TO ORDER A COMPLETE SHOWERING FAUCET









NOTES

 Moen® **M•PACT®** Common Valve System

WYNFORD™ Moentrol® Showering

All Brushed Nickel and Polished Nickel faucet components feature the LifeShine® Non-Tarnish Finish.

		MODEL NUMBER	LIST PRICE	FINISH/ CONNECTION	CASE QTY
MOENTROL® VALVE TRIM					
 <ul style="list-style-type: none"> valve sold separately  		T5501	159.60	Chrome	3
		T5501BN	347.05	Brushed Nickel	3
		T5501NL	347.05	Polished Nickel	3
		T5501ORB	347.05	Oil Rubbed Bronze	3
 		3510	210.05	1/2" IPS	6
	<ul style="list-style-type: none"> ports: four adjustable temperature limit stop: included includes: volume control 	3520	210.05	1/2" CC	6
 	<ul style="list-style-type: none"> ports: four adjustable temperature limit stop: included includes: volume control check stops: included 	3570	232.40	1/2" CC	6



HOW TO ORDER A COMPLETE VALVE











NOTES

 Moen® **M•PACT®** Common Valve System

WYNFORD™ Posi-Temp® Showering

All Brushed Nickel and Polished Nickel faucet components feature the LifeShine® Non-Tarnish Finish.

		MODEL NUMBER	LIST PRICE	FINISH/ CONNECTION	CASE QTY
POSI-TEMP® TUB/SHOWER					
	<ul style="list-style-type: none"> • showerhead functions: one-function • showerhead type: standard • showerhead size: 5-7/8" diameter spray head • showerhead flow rate: 2.5 gpm (9.5 L/min) max. • spout length: 7 15/16" • spout connection type: slip fit • tub spout type: diverter • valve sold separately 	T4503	266.35	Chrome	3
		T4503BN	441.70	Brushed Nickel	3
		T4503NL	441.70	Polished Nickel	3
		T4503ORB	441.70	Oil Rubbed Bronze	3
					
	<ul style="list-style-type: none"> • showerhead functions: one-function • showerhead type: eco-performance showerhead • showerhead size: 5-7/8" diameter spray head • showerhead flow rate: 1.75 gpm (6.65 L/min) max. • spout length: 7 15/16" • spout connection type: slip fit • tub spout type: diverter • valve sold separately 	T4503EP	266.35	Chrome	3
		T4503EPBN	441.70	Brushed Nickel	3
		T4503EPORB	441.70	Oil Rubbed Bronze	3
					
	<ul style="list-style-type: none"> • ports: four • adjustable temperature limit stop: included 	2510	152.20	1/2" IPS	6
		2520	152.20	1/2" CC	6
					
	<ul style="list-style-type: none"> • ports: four • adjustable temperature limit stop: included • quarter turn stops: included 	2570	194.75	1/2" CC	6
		2590	194.75	1/2" IPS	6
					

WYNFORD™

HOW TO ORDER A COMPLETE TUB/SHOWER FAUCET











NOTES

 Moen® **M•PACT®** Common Valve System

WYNFORD™ Posi-Temp® Showering

All Brushed Nickel and Polished Nickel faucet components feature the LifeShine® Non-Tarnish Finish.

		MODEL NUMBER	LIST PRICE	FINISH/ CONNECTION	CASE QTY
POSI-TEMP® SHOWER ONLY					
	<ul style="list-style-type: none"> • showerhead functions: one-function • showerhead type: standard • showerhead size: 5-7/8" diameter spray head • showerhead flow rate: 2.5 gpm (9.5 L/min) max. • valve sold separately 	T4502	208.20	Chrome	3
		T4502BN	359.50	Brushed Nickel	3
		T4502NL	359.50	Polished Nickel	3
		T4502ORB	359.50	Oil Rubbed Bronze	3
					
	<ul style="list-style-type: none"> • showerhead functions: one-function • showerhead type: eco-performance showerhead • showerhead size: 5-7/8" diameter spray head • showerhead flow rate: 1.75 gpm (6.65 L/min) max. • valve sold separately 	T4502EP	208.20	Chrome	3
		T4502EPBN	359.50	Brushed Nickel	3
		T4502EPORB	359.50	Oil Rubbed Bronze	3
					
	<ul style="list-style-type: none"> • ports: four • adjustable temperature limit stop: included 	2510	152.20	1/2" IPS	6
		2520	152.20	1/2" CC	6
					
	<ul style="list-style-type: none"> • ports: four • adjustable temperature limit stop: included • quarter turn stops: included 	2570	194.75	1/2" CC	6
		2590	194.75	1/2" IPS	6
					



HOW TO ORDER A COMPLETE SHOWER FAUCET















NOTES

 Moen® **M•PACT®** Common Valve System

WYNFORD™ Posi-Temp® Showering

All Brushed Nickel and Polished Nickel faucet components feature the LifeShine® Non-Tarnish Finish.

WYNFORD™

		MODEL NUMBER	LIST PRICE	FINISH/ CONNECTION	CASE QTY
POSI-TEMP® VALVE TRIM					
 <ul style="list-style-type: none"> valve sold separately  		T4501	142.25	Chrome	3
		T4501BN	268.75	Brushed Nickel	3
		T4501NL	268.75	Polished Nickel	3
		T4501ORB	268.75	Oil Rubbed Bronze	3
 <ul style="list-style-type: none"> ports: four adjustable temperature limit stop: included 		2510	152.20	1/2" IPS	6
		2520	152.20	1/2" CC	6
 <ul style="list-style-type: none"> ports: four adjustable temperature limit stop: included quarter turn stops: included 		2570	194.75	1/2" CC	6
		2590	194.75	1/2" IPS	6
TWO-HANDLE BIDET					
 <ul style="list-style-type: none"> valve sold separately  		T5245	517.00	Chrome	3
		T5245BN	759.75	Brushed Nickel	3
		T5245ORB	759.75	Oil Rubbed Bronze	3
 <ul style="list-style-type: none"> application: three hole centre dimensions: 8" - 16" centre  DURALOCK® DURALAST®		9265	319.85	1/2" IPS	6

HOW TO ORDER A COMPLETE VALVE



HOW TO ORDER A COMPLETE BIDET FAUCET

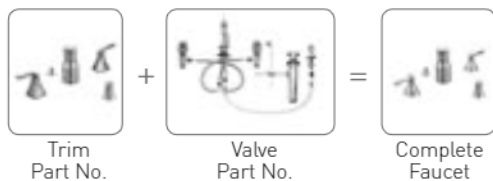

NOTES

-  Moen® **M•PACT®** Common Valve System
- DURALOCK®** Duralock™ Quick Connections
- DURALAST®** Duralast® Cartridge

WYNFORD™ Perfectly Matched Bath Accessories

Moen® makes it easy to coordinate the entire style and look of the bathroom. Our Wynford™ bath accessories perfectly match the style and finish of our Wynford faucets. Total coordination of the bath has never been easier.



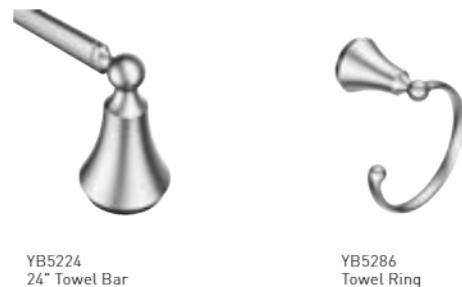
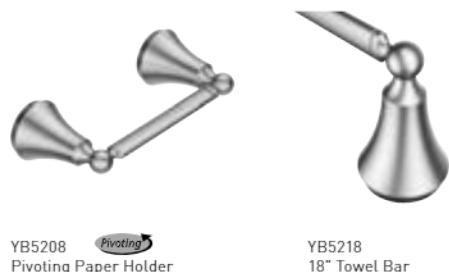
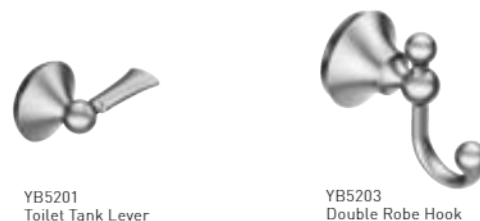









MODEL NUMBER	LIST PRICE EACH	DESCRIPTION	QTY
Chrome (CH)			
YB5201CH	43.85	Toilet Tank Lever	6
YB5203CH	36.40	Double Robe Hook	24
<i>Pivoting</i> YB5208CH	66.70	Pivoting Paper Holder	6
YB5218CH	77.40	18" Towel Bar	6
YB5222CH	102.65	24" Double Towel Bar	6
YB5224CH	79.90	24" Towel Bar	6
YB5286CH	54.45	Towel Ring	6
Brushed Nickel (BN)			
YB5201BN	49.95	Toilet Tank Lever	6
YB5203BN	41.55	Double Robe Hook	24
<i>Pivoting</i> YB5208BN	76.35	Pivoting Paper Holder	6
YB5218BN	87.85	18" Towel Bar	6
YB5222BN	114.20	24" Double Towel Bar	6
YB5224BN	91.10	24" Towel Bar	6
YB5286BN	61.15	Towel Ring	6
Polished Nickel (NL)			
YB5201NL	49.95	Toilet Tank Lever	6
YB5203NL	41.55	Double Robe Hook	24
<i>Pivoting</i> YB5208NL	76.35	Pivoting Paper Holder	6
YB5218NL	87.85	18" Towel Bar	6
YB5222NL	114.20	24" Double Towel Bar	6
YB5224NL	91.10	24" Towel Bar	6
YB5286NL	61.15	Towel Ring	6
Oil Rubbed Bronze (ORB)			
YB5201ORB	49.95	Toilet Tank Lever	6
YB5203ORB	41.55	Double Robe Hook	24
<i>Pivoting</i> YB5208ORB	76.35	Pivoting Paper Holder	6
YB5218ORB	87.85	18" Towel Bar	6
YB5222ORB	114.20	24" Double Towel Bar	6
YB5224ORB	91.10	24" Towel Bar	6
YB5286ORB	61.15	Towel Ring	6



ALIGN® Bathroom Faucets

All Brushed Nickel and Brushed Gold faucet components feature the LifeShine® Non-Tarnish Finish.

ALIGN®

		MODEL NUMBER	LIST PRICE	FINISH/ CONNECTION	CASE QTY
ONE-HANDLE BATHROOM FAUCET					
 <ul style="list-style-type: none"> • application: one or three hole • supply line length: flexible • connection size: 3/8" • connection type: compression • deck plate: included • drain assembly: metal • drain assembly type: lift rod   DURALAST®		6190	307.15	Chrome	3
		6190BN	456.15	Brushed Nickel	3
		6190BL	456.15	Matte Black	3
		6190BG	456.15	Brushed Gold	3
 <ul style="list-style-type: none"> • application: one or three hole • supply line length: flexible • connection size: 3/8" • connection type: compression • deck plate: sold separately • drain assembly: 140780 sold separately   DURALAST®		6192	411.15	Chrome	3
		6192BN	597.45	Brushed Nickel	3
		6192BG	597.45	Brushed Gold	3
			DECK PLATE SOLD SEPARATELY		
		172666	26.15	Chrome	20
	172666BN	38.60	Brushed Nickel	20	
	172666BG	38.60	Brushed Gold	20	
 <ul style="list-style-type: none"> • drain assembly : metal • drain assembly type: spring loaded pop-up 		140780	94.40	Chrome	12
		140780BN	136.05	Brushed Nickel	12
		140780BL	136.05	Matte Black	12
		140780BG	136.05	Brushed Gold	-
TWO-HANDLE WIDESPREAD BATHROOM FAUCET					
 <ul style="list-style-type: none"> • application: three hole • centre dimensions: 8" - 16" centre • supply line length: flexible • drain assembly: metal • drain assembly type: lift rod • valve sold separately   		T6193	341.55	Chrome	3
		T6193BN	484.55	Brushed Nickel	3
		T6193BL	484.55	Matte Black	3
		T6193BG	484.55	Brushed Gold	3
 <ul style="list-style-type: none"> • application: three hole • centre dimensions: 8" - 16" centre • drain assembly: metal • drain assembly type: lift rod  DURALOCK® DURALAST®		9000	148.70	1/2" IPS	6

HOW TO ORDER A COMPLETE BATHROOM FAUCET

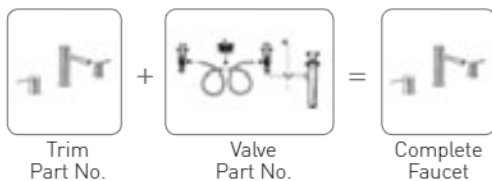





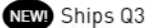

NOTES

-  Moen® **M•PACT®** Common Valve System
- DURALOCK®** Duralock™ Quick Connections
- DURALAST®** Duralast® Cartridge

ALIGN® Tub Fillers

All Brushed Nickel and Brushed Gold faucet components feature the LifeShine® Non-Tarnish Finish.

	MODEL NUMBER	LIST PRICE	FINISH/ CONNECTION	CASE QTY
FREESTANDING TUB FILLER				
  <ul style="list-style-type: none"> • application: one hole • showerhead type: handshower • handshower functions: one-function • handshower flow rate: 1.75 gpm (6.65 L/min) max. • spout reach: 8.75" • mounting kit: sold separately   DURALAST®	395	1,768.30	Chrome	1
	395BN	2,554.70	Brushed Nickel	1
	395BG	2,554.70	Brushed Gold	1
	395BL	2,554.70	Matte Black	1
 <ul style="list-style-type: none"> • description: single riser floor joist mounting kit • application: one hole • quarter turn stops: included 	TS50100	336.65	1/2" CC, NPT	2



HOW TO ORDER A COMPLETE FREESTANDING TUB FILLER FAUCET









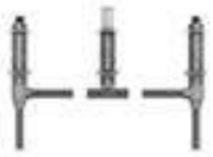

NOTES

 Moen® **M•FACT®** Common Valve System

ALIGN® Roman Tubs

All Brushed Nickel and Brushed Gold faucet components feature the LifeShine® Non-Tarnish Finish.

		MODEL NUMBER	LIST PRICE	FINISH/ CONNECTION	CASE QTY
TWO-HANDLE ROMAN TUB					
 <ul style="list-style-type: none"> • application: three hole • spout reach: 7.90" • valve sold separately 		T393	412.80	Chrome	3
		T393BN	661.80	Brushed Nickel	3
		T393BL	661.80	Matte Black	3
		T393BG	661.80	Brushed Gold	3
					
 <ul style="list-style-type: none"> • application: three hole • deck thickness: 1/8" to 3-3/8" rough deck • centre dimensions: adjustable • adjustable spout shank: included • test plug: included 		4792	188.00	1/2" CC	6
					
 <ul style="list-style-type: none"> • application: three hole • deck thickness: 1/8" to 1-7/8" deck • centre dimensions: 10" centre • non-adjustable spout shank: included • test plug: included 		4796 4798	179.95 179.95	1/2" CC 1/2" PEX, Cold Expansion PEX	6 6
					
 <ul style="list-style-type: none"> • description: high flow thermostatic mixing valve • 1/2" FNPT (3/8" compression adapters) • listed to ASSE Standard 1070 • max. flow rate at 45 psi = 10 gpm • tub application 		104465	223.55	1/2" FNPT	12
 <ul style="list-style-type: none"> • description: PEX transition fittings (2) and clips • adapts standard 1/2" PEX barb to 1/2" PEX cold expansion connections 		140715	11.35	1/2" PEX	200

ALIGN®

HOW TO ORDER A COMPLETE ROMAN TUB FAUCET

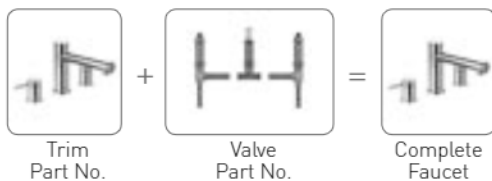









NOTES

 Moen® M•PACT® Common Valve System

ALIGN® Roman Tubs

All Brushed Nickel and Brushed Gold faucet components feature the LifeShine® Non-Tarnish Finish.

	MODEL NUMBER	LIST PRICE	FINISH/ CONNECTION	CASE QTY	
TWO-HANDLE ROMAN TUB WITH HANDSHOWER					
 <ul style="list-style-type: none"> • application: four hole • showerhead type: handshower • handshower functions: one-function • handshower flow rate: 1.75 gpm (6.65 L/min) max. • spout reach: 7.90" • valve sold separately  	T394 T394BN  T394BG	622.55 947.80 947.80	Chrome Brushed Nickel Brushed Gold	3 3 3	
	 <ul style="list-style-type: none"> • application: four hole • deck thickness: 1/8" to 2-5/8" deck • centre dimensions: 10" centre • non-adjustable spout shank: included • test plug: included 	9796 9797	358.95 358.95	1/2" CC 1/2" CPVC, PEX	6 6
		 <ul style="list-style-type: none"> • description: high flow thermostatic mixing valve • 1/2" FNPT (3/8" compression adapters) • listed to ASSE Standard 1070 • max. flow rate at 45 psi = 10 gpm • tub application 	104465	223.55	1/2" FNPT
 <ul style="list-style-type: none"> • description: PEX transition fittings (2) and clips • adapts standard 1/2" PEX barb to 1/2" PEX cold expansion connections 	140715	11.35	1/2" PEX	200	



HOW TO ORDER A COMPLETE ROMAN TUB FAUCET

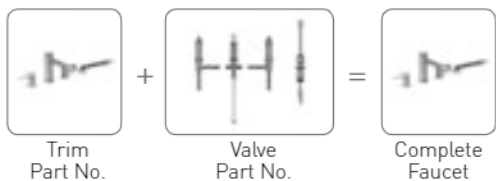









NOTES

 Moen® **M•PACT®** Common Valve System

ALIGN® 3/4" Thermostatic Showering

All Brushed Nickel and Brushed Gold faucet components feature the LifeShine® Non-Tarnish Finish.

	MODEL NUMBER	LIST PRICE	FINISH/ CONNECTION	CASE QTY
EXACTTEMP® VALVE ONLY				
 <ul style="list-style-type: none"> description: temperature control valve trim requires: separate volume control valve valve: sold separately 	T4291	280.00	Chrome	3
	T4291BN	472.30	Brushed Nickel	3
	T4291BG	472.30	Brushed Gold	3
	T4291BL	472.30	Matte Black	3
 <ul style="list-style-type: none"> description: thermostatic rough-in valve ports: four adjustable temp limit stop: included check stops: included 	S3371	626.05	3/4" IPS	6
EXACTTEMP® VOLUME CONTROL VALVE ONLY				
 <ul style="list-style-type: none"> valve: sold separately 	T4292	129.45	Chrome	6
	T4292BN	212.85	Brushed Nickel	6
	T4292BG	212.85	Brushed Gold	6
	T4292BL	212.85	Matte Black	6
 <ul style="list-style-type: none"> description: volume control rough-in valve includes: volume control 	S3600	141.15	3/4" IPS	12

ALIGN®

HOW TO ORDER A COMPLETE EXACTTEMP® VALVE

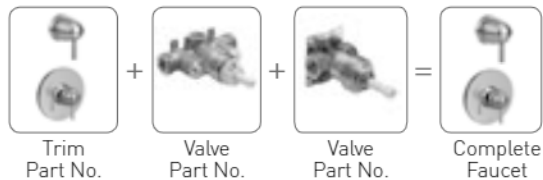











NOTES

Mojo Moen® **M•PACT®** Common Valve System

ALIGN® Transfer Valve Shower Spa Components

All Brushed Nickel and Brushed Gold faucet components feature the LifeShine® Non-Tarnish Finish.

		MODEL NUMBER	LIST PRICE	FINISH/ CONNECTION	CASE QTY
3 INDEPENDENT FUNCTION TRANSFER VALVE ONLY					
 <ul style="list-style-type: none"> • use with 3362 transfer valve • valve: sold separately  		T4192	136.85	Chrome	12
		T4192BN	205.25	Brushed Nickel	12
		T4192BL	205.25	Matte Black	12
		NEW! T4192BG	205.25	Brushed Gold	12
TRANSFER VALVE TRIM					
 <ul style="list-style-type: none"> • valve sold separately  		T4191	128.90	Chrome	12
		T4191BN	196.20	Brushed Nickel	12
		T4191BL	196.20	Matte Black	12
		NEW! T4191BG	196.20	Brushed Gold	12
 		3372	188.30	1/2" CC	12
	<ul style="list-style-type: none"> • type of function: two independent one shared • must be used with: Posi-Temp or Moentrol valve 				
 		3375	188.30	1/2" CC	12
	<ul style="list-style-type: none"> • type of function: two discrete • must be used with: Posi-Temp or Moentrol valve 				

HOW TO ORDER A COMPLETE TRANSFER VALVE















NOTES

 Moen® M-FACT® Common Valve System



ALIGN® Moentrol® Showering

All Brushed Nickel and Brushed Gold faucet components feature the LifeShine® Non-Tarnish Finish.

		MODEL NUMBER	LIST PRICE	FINISH/ CONNECTION	CASE QTY
MOENTROL® TUB/SHOWER					
 <ul style="list-style-type: none"> • showerhead functions: one-function • showerhead type: rainshower • showerhead size: 6" diameter spray head • showerhead flow rate: 2.5 gpm (9.5 L/min) max. • spout length: 7" • spout connection type: slip fit • tub spout type: diverter • valve sold separately 		T3293	348.00	Chrome	3
		T3293BN	604.70	Brushed Nickel	3
		T3293BG	604.70	Brushed Gold	3
  <ul style="list-style-type: none"> • ports: four • adjustable limit stop: included 		3510	210.05	1/2" IPS	6
		3520	210.05	1/2" CC	6
  <ul style="list-style-type: none"> • ports: four • adjustable limit stop: included • check stops: included 		3570	232.40	1/2" CC	6
MOENTROL® SHOWER ONLY					
 <ul style="list-style-type: none"> • showerhead functions: one-function • showerhead type: rainshower • showerhead size: 6" diameter spray head • showerhead flow rate: 2.5 gpm (9.5 L/min) max. • valve sold separately 		T3292	250.30	Chrome	3
		T3292BN	500.25	Brushed Nickel	3
		T3292BG	500.25	Brushed Gold	3
  <ul style="list-style-type: none"> • ports: four • adjustable temperature limit stop: included • includes: volume control 		3510	210.05	1/2" IPS	6
		3520	210.05	1/2" CC	6
  <ul style="list-style-type: none"> • ports: four • adjustable temperature limit stop: included • includes: volume control • check stops: included 		3570	232.40	1/2" CC	6

HOW TO ORDER A COMPLETE SHOWERING FAUCET











NOTES

-  Moen® **M•FACT**® Common Valve System
-  Immersion® Rainshower

ALIGN® Moentrol® Showering

All Brushed Nickel and Brushed Gold faucet components feature the LifeShine® Non-Tarnish Finish.

		MODEL NUMBER	LIST PRICE	FINISH/ CONNECTION	CASE QTY
MOENTROL® VALVE TRIM					
 <ul style="list-style-type: none"> valve sold separately 		T3291	159.60	Chrome	3
		T3291BN	347.05	Brushed Nickel	3
		T3291BG	347.05	Brushed Gold	3
	 				
	<ul style="list-style-type: none"> ports: four adjustable temperature limit stop: included includes: volume control 	3510	210.05	1/2" IPS	6
		3520	210.05	1/2" CC	6
					
	<ul style="list-style-type: none"> ports: four adjustable temperature limit stop: included includes: volume control check stops: included 	3570	232.40	1/2" CC	6
					



HOW TO ORDER A COMPLETE VALVE











NOTES

 Moen® **M•PACT®** Common Valve System

ALIGN® Posi-Temp® Showering

All Brushed Nickel and Brushed Gold faucet components feature the LifeShine® Non-Tarnish Finish.

		MODEL NUMBER	LIST PRICE	FINISH/ CONNECTION	CASE QTY
POSI-TEMP® TUB/SHOWER					
	<ul style="list-style-type: none"> • showerhead functions: one-function • showerhead type: standard • showerhead size: 3-5/8" diameter spray head • showerhead flow rate: 2.5 gpm (9.5 L/min) max. • spout length: 7 3/8" • spout connection type: slip fit • tub spout type: diverter • valve sold separately 	T2193	235.70	Chrome	3
		T2193BN	419.60	Brushed Nickel	3
		T2193BL	419.60	Matte Black	3
		T2193BG	419.60	Brushed Gold	3
					
	<ul style="list-style-type: none"> • showerhead functions: one-function • showerhead type: eco-performance showerhead spray head • showerhead size: 3-5/8" diameter • showerhead flow rate: 1.75 gpm (6.65 L/min) max. • spout length: 7 3/8" • spout connection type: slip fit • tub spout type: diverter • valve sold separately 	T2193EP	235.70	Chrome	3
		T2193EPBN	419.60	Brushed Nickel	3
		T2193EPBL	419.60	Matte Black	3
		T2193EPBG	419.60	Brushed Gold	3
					
	<ul style="list-style-type: none"> • ports: four • adjustable temperature limit stop: included 	2510	152.20	1/2" IPS	6
		2520	152.20	1/2" CC	6
					
	<ul style="list-style-type: none"> • ports: four • adjustable temperature limit stop: included • quarter turn stops: included 	2570	194.75	1/2" CC	6
		2590	194.75	1/2" IPS	6
					

ALIGN®

HOW TO ORDER A COMPLETE TUB/SHOWER FAUCET











NOTES

 Moen® **M•PACT®** Common Valve System

ALIGN® Posi-Temp® Showering

All Brushed Nickel and Brushed Gold faucet components feature the LifeShine® Non-Tarnish Finish.

		MODEL NUMBER	LIST PRICE	FINISH/ CONNECTION	CASE QTY
POSI-TEMP® SHOWER ONLY					
 <ul style="list-style-type: none"> • showerhead functions: one-function • showerhead type: standard • showerhead size: 3-5/8" diameter spray head • showerhead flow rate: 2.5 gpm (9.5 L/min) max. • red/blue markings: included • valve sold separately 		T2192	163.40	Chrome	3
		T2192BN	319.95	Brushed Nickel	3
		T2192BL	319.95	Matte Black	3
	NEW!	T2192BG	319.95	Brushed Gold	3
 <ul style="list-style-type: none"> • showerhead functions: one-function • showerhead type: eco-performance showerhead • showerhead size: 3-5/8" diameter spray head • showerhead flow rate: 1.75 gpm (6.65 L/min) max. • red/blue markings: included • valve sold separately 		T2192EP	163.40	Chrome	3
		T2192EPBN	319.95	Brushed Nickel	3
		T2192EPBL	319.95	Matte Black	3
	NEW!	T2192EPBG	319.95	Brushed Gold	3
 		2510	152.20	1/2" IPS	6
		2520	152.20	1/2" CC	6
 		2570	194.75	1/2" CC	6
		2590	194.75	1/2" IPS	6



HOW TO ORDER A COMPLETE SHOWER FAUCET













NOTES

 Moen® **M•PACT®** Common Valve System

ALIGN® Posi-Temp® Showering

All Brushed Nickel faucet components feature the LifeShine® Non-Tarnish Finish.

ALIGN®

		MODEL NUMBER	LIST PRICE	FINISH/ CONNECTION	CASE QTY
POSI-TEMP® TUB/SHOWER					
	<ul style="list-style-type: none"> • showerhead type: showerhead sold separately • spout length: 7 3/8" • spout connection type: slip fit • tub spout type: diverter • valve sold separately 	T2193NHBL	342.80	Matte Black	3
					
	<ul style="list-style-type: none"> • showerhead type: showerhead sold separately • valve sold separately 	T2192NHBL	243.15	Matte Black	3
					
	<ul style="list-style-type: none"> • ports: four • adjustable temp limit stop: included 	2510 2520	152.20 152.20	1/2" IPS 1/2" CC	6 6
					
	<ul style="list-style-type: none"> • ports: four • adjustable temp limit stop: included • quarter turn stops: included 	2570 2590	194.75 194.75	1/2" CC 1/2" IPS	6 6
					
	<ul style="list-style-type: none"> • connection size: 1/2" • connection type: IPS • showerhead functions: one-function • showerhead type: standard • showerhead size: 3-5/8" diameter spray head • type of function: full spray • flow rate: 2.5 gpm (9.5 L/min) max. 	6399BL	128.80	Matte Black	12
	<ul style="list-style-type: none"> • connection size: 1/2" • connection type: IPS • showerhead functions: one-function • showerhead type: eco-performance showerhead • showerhead size: 3-5/8" diameter spray head • type of function: full spray • flow rate: 1.75 gpm (6.65 L/min) max. 	6399EPBL	128.80	Matte Black	12
					

HOW TO ORDER A COMPLETE TUB/SHOWER FAUCET

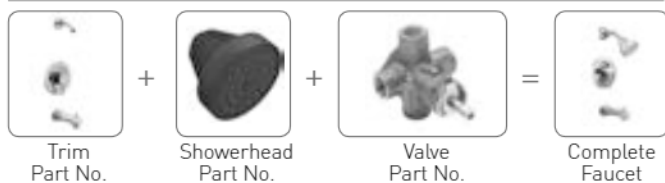













NOTES

 Moen® **M•PACT®** Common Valve System

ALIGN® Posi-Temp® Showering, Bidets

All Brushed Nickel and Brushed Gold faucet components feature the LifeShine® Non-Tarnish Finish.

	MODEL NUMBER	LIST PRICE	FINISH/ CONNECTION	CASE QTY
POSI-TEMP® VALVE TRIM				
 <ul style="list-style-type: none"> • red/blue markings: included • valve sold separately  	T2191	96.80	Chrome	3
	T2191BN	237.25	Brushed Nickel	3
	T2191BL	237.25	Matte Black	3
	T2191BG	237.25	Brushed Gold	3
 <ul style="list-style-type: none"> • ports: four • adjustable limit stop: included 	2510	152.20	1/2" IPS	6
	2520	152.20	1/2" CC	6
 <ul style="list-style-type: none"> • ports: four • adjustable temperature limit stop: included • quarter turn stops: included 	2570	194.75	1/2" CC	6
	2590	194.75	1/2" IPS	6
TWO-HANDLE BIDET				
 <ul style="list-style-type: none"> • valve sold separately  	T5191	517.00	Chrome	3
	T5191BN	759.75	Brushed Nickel	3
 <ul style="list-style-type: none"> • application: three hole • centre dimensions: 8" - 16" centre  DURALOCK® DURALAST®	9265	319.85	1/2" IPS	6



HOW TO ORDER A COMPLETE VALVE



HOW TO ORDER A COMPLETE BIDET FAUCET

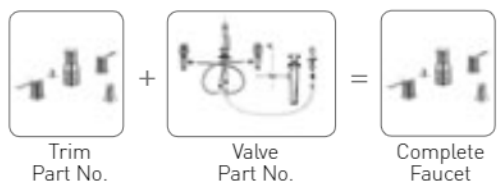





NOTES

-  Moen® **M•PACT®** Common Valve System
- DURALOCK®** Duralock™ Quick Connections
- DURALAST®** Duralast® Cartridge

ALIGN® Perfectly Matched Bath Accessories

Moen® makes it easy to coordinate the entire style and look of the bathroom. Our Align® bath accessories perfectly match the style and finish of our Align faucets. Total coordination of the bath has never been easier.

MODEL NUMBER	LIST PRICE EACH	DESCRIPTION	5/8-in. Round Bar	QTY
Chrome (CH)				
YB0402CH	65.05	Swiveling Double Robe Hook		24
YB0403CH	36.00	Robe Hook		24
 YB0408CH	65.75	Pivoting Paper Holder		6
YB0409CH	56.00	Single-Post Paper Holder		6
YB0418CH	76.25	18" Towel Bar		6
YB0424CH	78.65	24" Towel Bar		6
YB0486CH	53.60	Mini Towel Bar		6
Brushed Nickel (BN)				
YB0402BN	72.45	Swiveling Double Robe Hook		24
YB0403BN	38.70	Robe Hook		24
 YB0408BN	71.20	Pivoting Paper Holder		6
YB0409BN	60.30	Single-Post Paper Holder		6
YB0418BN	82.20	18" Towel Bar		6
YB0424BN	85.15	24" Towel Bar		6
YB0486BN	57.40	Mini Towel Bar		6
Matte Black (BL)				
YB0402BL	72.45	Swiveling Double Robe Hook		24
YB0403BL	38.70	Robe Hook		24
 YB0408BL	71.20	Pivoting Paper Holder		6
YB0409BL	60.30	Single-Post Paper Holder		6
YB0418BL	82.20	18" Towel Bar		6
YB0424BL	85.15	24" Towel Bar		6
YB0486BL	57.40	Mini Towel Bar		6
Brushed Gold (BG)				
 YB0403BG	38.70	Robe Hook		24
 YB0408BG	71.20	Pivoting Paper Holder		6
YB0418BG	82.20	18" Towel Bar		6
YB0424BG	85.15	24" Towel Bar		6
YB0486BG	57.40	Mini Towel Bar		6



YB0402 Swiveling Double Robe Hook



YB0403 Robe Hook



YB0408 Pivoting Paper Holder



YB0409 Single-Post Paper Holder



YB0418 18" Towel Bar



YB0424 24" Towel Bar



YB0486 Mini Towel Bar

ALIGN®

GRAB BARS

PERFECTLY MATCHED to Moen® Align® faucets and bath accessories. ADA-compliant.



SecureMount™ Grab Bars are manufactured with an innovative flange design that makes it easy to connect to the stud at multiple points.

To install grab bars securely without studs, use SecureMount™ Anchors. Sold separately.

MODEL NUMBER	LIST PRICE EACH	DESCRIPTION	QTY
1-1/4" • Chrome (CH)			
YG0412CH	108.20	12" Grab Bar	6
YG0418CH	113.05	18" Grab Bar	6
YG0424CH	118.05	24" Grab Bar	6
YG0436CH	134.40	36" Grab Bar	6
YG0442CH	197.10	42" Grab Bar	6
1-1/4" • Brushed Nickel (BN)			
YG0412BN	130.65	12" Grab Bar	6
YG0418BN	137.05	18" Grab Bar	6
YG0424BN	147.80	24" Grab Bar	6
YG0436BN	166.45	36" Grab Bar	6
YG0442BN	246.45	42" Grab Bar	6
1-1/4" • Brushed Gold (BG)			
YG0418BG	137.05	18" Grab Bar	6
YG0424BG	147.80	24" Grab Bar	6
SecureMount Anchors™			
SMA1005CH	21.20	SecureMount Anchors™ (1 pc Chrome Mounting Plates)	3
SMA1000WB	48.80	SecureMount Anchors™ (2 pc Old World Bronze Mounting Plates)	24

NEW!



Complies with Americans with Disabilities Act (ADA) specifications. SecureMount™ Grab Bars are tested to withstand 500 lb. pull when securely installed per instructions.

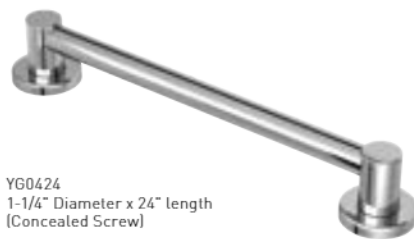













YG0424
1-1/4" Diameter x 24" length
(Concealed Screw)



VOSS™ Bathroom Faucets

All Brushed Nickel and Brushed Gold faucet components feature the LifeShine® Non-Tarnish Finish.

		MODEL NUMBER	LIST PRICE	FINISH/ CONNECTION	CASE QTY
ONE-HANDLE BATHROOM FAUCET					
 <ul style="list-style-type: none"> • application: one or three hole • supply line length: flexible • connection size: 3/8" • connection type: compression • deck plate: included • drain assembly: metal • drain assembly type: lift rod   DURALAST™		6903	326.50	Chrome	3
		6903BN	539.50	Brushed Nickel	3
		6903ORB	539.50	Oil Rubbed Bronze	3
		NEW! 6903BG	539.50	Brushed Gold	3
		NEW! 6903NL*	539.50	Polished Nickel	-
TWO-HANDLE BATHROOM FAUCET					
 <ul style="list-style-type: none"> • application: three hole • centre dimensions: 4" centre • connection size: 1/2" • connection type: IPS • drain assembly: metal • drain assembly type: lift rod  		6901	313.80	Chrome	3
		6901BN	500.60	Brushed Nickel	3
		6901ORB	500.60	Oil Rubbed Bronze	3
		NEW! 6901BG	500.60	Brushed Gold	3
		NEW! 6901NL*	500.60	Polished Nickel	-
TWO-HANDLE WIDESPREAD BATHROOM FAUCET					
 <ul style="list-style-type: none"> • application: three hole • centre dimensions: 8" - 16" centre • drain assembly: metal • drain assembly type: lift rod • valve sold separately   		T6905	352.45	Chrome	3
		T6905BN	564.05	Brushed Nickel	3
		T6905ORB	564.05	Oil Rubbed Bronze	3
		NEW! T6905BG	564.05	Brushed Gold	3
		NEW! T6905NL*	564.05	Polished Nickel	-
  DURALOCK™ DURALAST™		9000	148.70	1/2" IPS	6

HOW TO ORDER A COMPLETE BATHROOM FAUCET

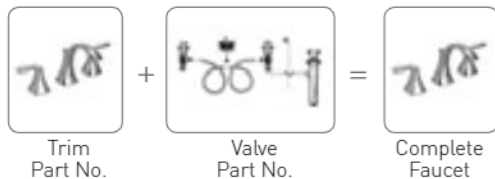







NOTES

-  Moen® **M•PACT**® Common Valve System
- DURALOCK™** Duralock™ Quick Connections
- DURALAST™** Duralast™ Cartridge
- *Ships Q2

VOSS™ Bathroom Faucets

All Brushed Nickel and Brushed Gold faucet components feature the LifeShine® Non-Tarnish Finish.

	MODEL NUMBER	LIST PRICE	FINISH/ CONNECTION	CASE QTY
TWO-HANDLE WALL MOUNT BATHROOM FAUCET				
 <ul style="list-style-type: none"> • application: three hole • centre dimensions: 8" centre • spout reach: 7.37" • drain assembly: 140780 sold separately • valve sold separately   	T6906	324.60	Chrome	3
	T6906BN	537.55	Brushed Nickel	3
	T6906ORB	537.55	Oil Rubbed Bronze	3
	NEW! T6906BG	537.55	Brushed Gold	3
	NEW! T6906NL*	537.55	Polished Nickel	-
 <ul style="list-style-type: none"> • application: three hole • centre dimensions: 8" centre • drain assembly: 140780 sold separately • includes: mounting brackets 	9700	219.75	1/2" CC	3
	 <ul style="list-style-type: none"> • drain assembly: metal • drain assembly type: spring loaded pop-up 	140780	94.40	Chrome
140780BN		136.05	Brushed Nickel	12
140780ORB		136.05	Oil Rubbed Bronze	12
NEW! 140780BG		136.05	Brushed Gold	-



HOW TO ORDER A COMPLETE BATHROOM FAUCET







NOTES

© Moen® **M•PACT**® Common Valve System

*Ships Q2

VOSS™ Tub Filler Faucets

All Brushed Nickel and Brushed Gold faucet components feature the LifeShine® Non-Tarnish Finish.

		MODEL NUMBER	LIST PRICE	FINISH/ CONNECTION	CASE QTY
FREESTANDING TUB FILLER					
 <ul style="list-style-type: none"> • application: one hole • showerhead type: handshower • handshower functions: one-function • handshower flow rate: 1.75 gpm (6.65 L/min) max. • spout reach: 9.75" • valve: sold separately   DURALAST®		695	1,821.70	Chrome	0
		695BN	2,692.25	Brushed Nickel	1
		695ORB	2,692.25	Oil Rubbed Bronze	1
		NEW! 695BG	2,692.25	Brushed Gold	1
		NEW! 695NL*	2,692.25	Polished Nickel	1
 <ul style="list-style-type: none"> • description: single riser floor joist mounting kit • application: one hole • quarter turn stops: included 		TS50100	336.65	1/2" NPT, CC	2

VOSS™

HOW TO ORDER A COMPLETE TUB FILLER



NOTES









 Moen® **M•PACT®** Common Valve System

*Ships Q2

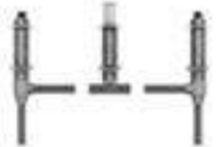
Refer to specification sheet for critical dimensions for installation.

VOSS™ Roman Tub

All Brushed Nickel and Brushed Gold faucet components feature the LifeShine® Non-Tarnish Finish.

	MODEL NUMBER	LIST PRICE	FINISH/ CONNECTION	CASE QTY
TWO-HANDLE ROMAN TUB				
 <ul style="list-style-type: none"> • application: three hole • spout reach: 8.25" • valve sold separately  	T693	413.60	Chrome	3
	T693BN	644.10	Brushed Nickel	3
	T693ORB	644.10	Oil Rubbed Bronze	3
	NEW! T693BG	644.10	Brushed Gold	3
	NEW! T693NL*	644.10	Polished Nickel	-
 <ul style="list-style-type: none"> • application: three hole • deck thickness: 1/8" to 3-3/8" rough deck • centre dimensions: adjustable • adjustable spout shank: included • test plug: included 	4792	188.00	1/2" CC	6
 <ul style="list-style-type: none"> • application: three hole • deck thickness: 1/8" to 1-7/8" deck • centre dimensions: 10" centre • non-adjustable spout shank: included • test plug: included 	4796 4798	179.95 179.95	1/2" CC 1/2" PEX, Cold Expansion PEX	6 6
 <ul style="list-style-type: none"> • description: high flow thermostatic mixing valve • 1/2" FNPT (3/8" compression adapters) • listed to ASSE Standard 1070 • max. flow rate at 45 psi = 10 gpm • tub application 	104465	223.55	1/2" FNPT	12
 <ul style="list-style-type: none"> • description: PEX transition fittings (2) and clips • adapts standard 1/2" PEX barb to 1/2" PEX cold expansion connections 	140715	11.35	1/2" PEX	200



HOW TO ORDER A COMPLETE ROMAN TUB FAUCET

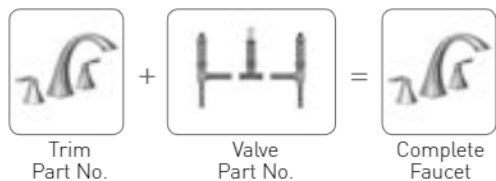







NOTES

 Moen® **M•FACT**® Common Valve System
*Ships Q2

VOSS™ Roman Tub

All Brushed Nickel and Brushed Gold faucet components feature the LifeShine® Non-Tarnish Finish.

		MODEL NUMBER	LIST PRICE	FINISH/ CONNECTION	CASE QTY
TWO-HANDLE ROMAN TUB WITH HANDSHOWER					
 <ul style="list-style-type: none"> • application: four hole • showerhead type: handshower • handshower functions: one-function • handshower flow rate: 1.75 gpm (6.65 L/min) max. • spout reach: 8.25" • valve sold separately 		T694	657.90	Chrome	3
		T694BN	1,078.50	Brushed Nickel	3
		T694ORB	1,078.50	Oil Rubbed Bronze	3
		T694BG	1,078.50	Brushed Gold	3
		T694NL*	1,078.50	Polished Nickel	-
 <ul style="list-style-type: none"> • application: four hole • deck thickness: 1/8" to 2-5/8" deck • centre dimensions: 10" centre • non-adjustable spout shank: included • test plug: included 		9796	358.95	1/2" CC	6
		9797	358.95	1/2" CPVC, PEX	6
 <ul style="list-style-type: none"> • description: high flow thermostatic mixing valve • 1/2" FNPT (3/8" compression adapters) • listed to ASSE Standard 1070 • max. flow rate at 45 psi = 10 gpm • tub application 		104465	223.55	1/2" FNPT	12
 <ul style="list-style-type: none"> • description: PEX transition fittings (2) and clips • adapts standard 1/2" PEX barb to 1/2" PEX cold expansion connections 		140715	11.35	1/2" PEX	200

VOSS™

HOW TO ORDER A COMPLETE ROMAN TUB FAUCET

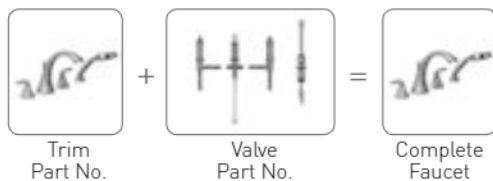









NOTES

 Moen® **M•PACT**® Common Valve System
*Ships Q2

VOSS™ 3/4" Thermostatic Showering

All Brushed Nickel and Brushed Gold faucet components feature the LifeShine® Non-Tarnish Finish.

	MODEL NUMBER	LIST PRICE	FINISH/ CONNECTION	CASE QTY
EXACTTEMP® VALVE ONLY				
 <ul style="list-style-type: none"> • description: temperature control valve trim • requires: separate volume control valve • valve: sold separately 	T4691	280.00	Chrome	3
	T4691BN	472.30	Brushed Nickel	-
	T4691BG	472.30	Brushed Gold	3
	T4691NL*	472.30	Polished Nickel	3
	T4691ORB	472.30	Oil Rubbed Bronze	3
 <ul style="list-style-type: none"> • description: thermostatic rough-in valve • ports: four • adjustable temp limit stop: included • check stops: included 	S3371	626.05	3/4" IPS	6
EXACTTEMP® VOLUME CONTROL VALVE ONLY				
 <ul style="list-style-type: none"> • valve: sold separately 	T4692	129.45	Chrome	6
	T4692BN	212.85	Brushed Nickel	6
	T4692BG	212.85	Brushed Gold	6
	T4692NL*	212.85	Polished Nickel	-
	T4692ORB	212.85	Oil Rubbed Bronze	6
 <ul style="list-style-type: none"> • description: volume control rough-in valve • includes: volume control 	S3600	141.15	3/4" IPS	12



HOW TO ORDER A COMPLETE EXACTTEMP® VALVE

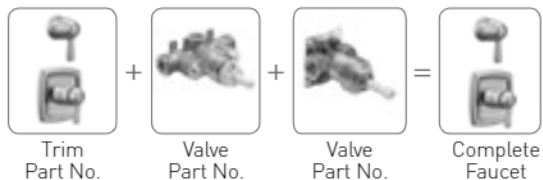













NOTES

 Moen® **M•PACT®** Common Valve System
 *Ships Q2

VOSS™ Transfer Valve Shower Spa Components

All Brushed Nickel and Brushed Gold faucet components feature the LifeShine® Non-Tarnish Finish.

		MODEL NUMBER	LIST PRICE	FINISH/ CONNECTION	CASE QTY
3 INDEPENDENT FUNCTION TRANSFER VALVE ONLY					
 <ul style="list-style-type: none"> • use with 3362 transfer valve • valve: sold separately  		T4612	134.25	Chrome	12
		T4612BN	205.25	Brushed Nickel	12
		T4612ORB	205.25	Oil Rubbed Bronze	12
		NEW! T4612BG	205.25	Brushed Gold	12
		NEW! T4612NL*	205.25	Polished Nickel	-
 <ul style="list-style-type: none"> • Ports: four • type of function: three independent function • must be used with: Posi-Temp® or Moentrol® valve  		3362	215.60	1/2" CC	6
TRANSFER VALVE TRIM					
 <ul style="list-style-type: none"> • valve sold separately  		T4611	128.90	Chrome	12
		T4611BN	196.20	Brushed Nickel	12
		T4611ORB	196.20	Oil Rubbed Bronze	12
		NEW! T4611BG	196.20	Brushed Gold	12
		NEW! T4611NL*	196.20	Polished Nickel	-
 <ul style="list-style-type: none"> • type of function: two independent one shared • must be used with: Posi-Temp or Moentrol valve 		3372	188.30	1/2" CC	12
 <ul style="list-style-type: none"> • type of function: two discrete • must be used with: Posi-Temp or Moentrol valve 		3375	188.30	1/2" CC	12

VOSS™

HOW TO ORDER A COMPLETE TRANSFER VALVE















NOTES

 Moen® **M•PACT**® Common Valve System
*Ships Q2

VOSS™ Moentrol® Showering

All Brushed Nickel and Brushed Gold faucet components feature the LifeShine® Non-Tarnish Finish.



	MODEL NUMBER	LIST PRICE	FINISH/ CONNECTION	CASE QTY
MOENTROL® TUB/SHOWER				
 <ul style="list-style-type: none"> • showerhead functions: one-function • showerhead type: rainshower • showerhead size: 6" diameter spray head • showerhead flow rate: 2.5 gpm (9.5 L/min) max. • spout length: 7 15/16" • spout connection type: slip fit • tub spout type: diverter • valve sold separately 	T3693	348.00	Chrome	3
	T3693BN	604.70	Brushed Nickel	3
	T3693ORB	604.70	Oil Rubbed Bronze	3
	NEW! T3693BG	604.70	Brushed Gold	3
	NEW! T3693NL*	604.70	Polished Nickel	-
 <ul style="list-style-type: none"> • Ports: four • adjustable temperature limit stop: included • includes: volume control 	3510	210.05	1/2" IPS	6
	3520	210.05	1/2" CC	6
	 <ul style="list-style-type: none"> • Ports: four • adjustable temperature limit stop: included • includes: volume control • check stops: included 	3570	232.40	1/2" CC
MOENTROL® SHOWER ONLY				
 <ul style="list-style-type: none"> • showerhead functions: one-function • showerhead type: rainshower • showerhead size: 6" diameter spray head • showerhead flow rate: 2.5 gpm (9.5 L/min) max. • valve sold separately 		T3692	250.30	Chrome
	T3692BN	500.25	Brushed Nickel	3
	T3692ORB	500.25	Oil Rubbed Bronze	3
	NEW! T3692BG	500.25	Brushed Gold	3
	NEW! T3692NL*	500.25	Polished Nickel	-
 <ul style="list-style-type: none"> • Ports: four • adjustable temperature limit stop: included • includes: volume control 	3510	210.05	1/2" IPS	6
	3520	210.05	1/2" CC	6
	 <ul style="list-style-type: none"> • Ports: four • adjustable temperature limit stop: included • includes: volume control • check stops: included 	3570	232.40	1/2" CC



HOW TO ORDER A COMPLETE SHOWERING FAUCET









NOTES

-  Moen® **M•PACT**® Common Valve System
-  Immersion® Rainshower
- *Ships Q2

VOSS™ Moentrol® Showering

All Brushed Nickel and Brushed Gold faucet components feature the LifeShine® Non-Tarnish Finish.

		MODEL NUMBER	LIST PRICE	FINISH/ CONNECTION	CASE QTY
MOENTROL® VALVE TRIM					
 <ul style="list-style-type: none"> valve sold separately 		T3691	159.60	Chrome	3
		T3691BN	347.05	Brushed Nickel	3
		T3691ORB	347.05	Oil Rubbed Bronze	3
		NEW! T3691BG	347.05	Brushed Gold	3
		NEW! T3691NL*	347.05	Polished Nickel	-
					
 <ul style="list-style-type: none"> Ports: four adjustable temperature limit stop: included includes: volume control 		3510	210.05	1/2" IPS	6
		3520	210.05	1/2" CC	6
					
 <ul style="list-style-type: none"> Ports: four adjustable temperature limit stop: included includes: volume control check stops: included 		3570	232.40	1/2" CC	6
					

VOSS™

HOW TO ORDER A COMPLETE VALVE















NOTES

 Moen® **M•PACT®** Common Valve System
*Ships Q2

VOSS™ Posi-Temp® Showering

All Brushed Nickel and Brushed Gold faucet components feature the LifeShine® Non-Tarnish Finish.

		MODEL NUMBER	LIST PRICE	FINISH/ CONNECTION	CASE QTY
POSI-TEMP® TUB/SHOWER					
 <ul style="list-style-type: none"> • showerhead functions: one-function • showerhead type: standard • showerhead size: 4-1/16" diameter spray head • showerhead flow rate: 2.5 gpm (9.5 L/min) max. • spout length: 7 3/4" • spout connection type: slip fit • tub spout type: diverter • valve sold separately 		T2693	266.35	Chrome	3
		T2693BN	441.70	Brushed Nickel	3
		T2693ORB	441.70	Oil Rubbed Bronze	3
		 T2693BG	441.70	Brushed Gold	3
		 T2693NL*	441.70	Polished Nickel	-
 <ul style="list-style-type: none"> • showerhead functions: one-function • showerhead type: eco-performance showerhead • showerhead size: 4-1/16" diameter spray head • showerhead flow rate: 1.75 gpm (6.65 L/min) max. • spout length: 7 3/4" • spout connection type: slip fit • tub spout type: diverter • valve sold separately 		T2693EP	266.35	Chrome	3
		T2693EPBN	441.70	Brushed Nickel	3
		T2693EPORB	441.70	Oil Rubbed Bronze	3
		 T2693EPBG	441.70	Brushed Gold	3
		 T2693EPNL*	441.70	Brushed Gold	-
 <ul style="list-style-type: none"> • Ports: four • adjustable temperature limit stop: included 		2510	152.20	1/2" IPS	6
		2520	152.20	1/2" CC	6
 <ul style="list-style-type: none"> • Ports: four • adjustable temperature limit stop: included • quarter turn stops: included 		2570	194.75	1/2" CC	6
		2590	194.75	1/2" IPS	6

HOW TO ORDER A COMPLETE TUB/SHOWER FAUCET











NOTES

 Moen® **M•FACT®** Common Valve System
*Ships Q2



VOSS™ Posi-Temp® Showering

All Brushed Nickel and Brushed Gold faucet components feature the LifeShine® Non-Tarnish Finish.

		MODEL NUMBER	LIST PRICE	FINISH/ CONNECTION	CASE QTY
POSI-TEMP® SHOWER ONLY					
 <ul style="list-style-type: none"> • showerhead functions: one-function • showerhead type: standard • showerhead size: 4-1/16" diameter spray head • showerhead flow rate: 2.5 gpm (9.5 L/min) max. • valve sold separately 		T2692	208.20	Chrome	3
		T2692BN	359.50	Brushed Nickel	3
		T2692ORB	359.50	Oil Rubbed Bronze	3
		NEW! T2692BG	359.50	Brushed Gold	3
		NEW! T2692NL*	359.50	Polished Nickel	-
 <ul style="list-style-type: none"> • showerhead functions: one-function • showerhead type: eco-performance showerhead • showerhead size: 4-1/16" diameter spray head • showerhead flow rate: 1.75 gpm (6.65 L/min) max. • valve sold separately 		T2692EP	208.20	Chrome	3
		T2692EPBN	359.50	Brushed Nickel	3
		T2692EPORB	359.50	Oil Rubbed Bronze	3
		NEW! T2692EPBG	359.50	Brushed Gold	3
		NEW! T2692EPNL*	359.50	Polished Nickel	-
 <ul style="list-style-type: none"> • Ports: four • adjustable temperature limit stop: included 		2510	152.20	1/2" IPS	6
		2520	152.20	1/2" CC	6
 <ul style="list-style-type: none"> • Ports: four • adjustable temperature limit stop: included • quarter turn stops: included 		2570	194.75	1/2" CC	6
		2590	194.75	1/2" IPS	6

VOSS™

HOW TO ORDER A COMPLETE SHOWER FAUCET















NOTES

 Moen® **M•PACT®** Common Valve System
*Ships Q2

VOSS™ Posi-Temp® Showering, Bidets

All Brushed Nickel and Brushed Gold faucet components feature the LifeShine® Non-Tarnish Finish.

		MODEL NUMBER	LIST PRICE	FINISH/ CONNECTION	CASE QTY
POSI-TEMP® VALVE TRIM					
 <ul style="list-style-type: none"> valve sold separately  		T2691	142.25	Chrome	3
		T2691BN	268.75	Brushed Nickel	3
		T2691ORB	268.75	Oil Rubbed Bronze	3
		T2691BG	268.75	Brushed Gold	3
		T2691NL*	268.75	Polished Nickel	-
 <ul style="list-style-type: none"> Ports: four adjustable temperature limit stop: included 		2510	152.20	1/2" IPS	6
		2520	152.20	1/2" CC	6
 <ul style="list-style-type: none"> Ports: four adjustable temperature limit stop: included quarter turn stops: included 		2570	194.75	1/2" CC	6
		2590	194.75	1/2" IPS	6
TWO-HANDLE BIDET					
 <ul style="list-style-type: none"> valve sold separately  		T5269	517.00	Chrome	3
		T5269BN	759.75	Brushed Nickel	3
		T5269ORB	759.75	Oil Rubbed Bronze	3
 <ul style="list-style-type: none"> application: three hole centre dimensions: 8" - 16" centre  DURALOCK® DURALAST®		9265	319.85	1/2" IPS	6



HOW TO ORDER A COMPLETE VALVE



HOW TO ORDER A COMPLETE BIDET FAUCET

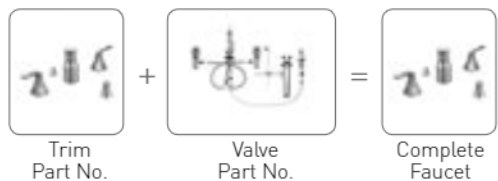

NOTES

-  Moen® **M•PACT®** Common Valve System
- DURALOCK®** Duralock™ Quick Connections
- DURALAST®** Duralast® Cartridge
- *Ships Q2

VOSS™ Perfectly Matched Bath Accessories

Moen® makes it easy to coordinate the entire style and look of the bathroom. Our Voss™ bath accessories perfectly match the style and finish of our Voss faucets. Total coordination of the bath has never been easier.

MODEL NUMBER	LIST PRICE EACH	DESCRIPTION	QTY
Chrome (CH)			
YB5101CH	43.85	Toilet Tank Lever	24
YB5103CH	36.40	Double Robe Hook	24
<i>Pivoting</i> YB5108CH	66.70	Pivoting Paper Holder	6
YB5118CH	77.40	18" Towel Bar	6
YB5124CH	79.90	24" Towel Bar	6
YB5170CH	52.35	Wallmount Hairdryer Holder	6
YB5186CH	54.45	Towel Ring	6
Brushed Nickel (BN)			
YB5101BN	49.95	Toilet Tank Lever	24
YB5103BN	41.55	Double Robe Hook	24
<i>Pivoting</i> YB5108BN	76.35	Pivoting Paper Holder	6
YB5118BN	87.85	18" Towel Bar	6
YB5124BN	91.10	24" Towel Bar	6
YB5170BN	54.95	Wallmount Hairdryer Holder	6
YB5186BN	61.15	Towel Ring	6
Oil Rubbed Bronze (ORB)			
YB5101ORB	49.95	Toilet Tank Lever	24
YB5103ORB	41.55	Double Robe Hook	24
<i>Pivoting</i> YB5108ORB	76.35	Pivoting Paper Holder	6
YB5118ORB	87.85	18" Towel Bar	6
YB5124ORB	91.10	24" Towel Bar	6
YB5170ORB	54.95	Wallmount Hairdryer Holder	6
YB5186ORB	61.15	Towel Ring	6
NEW!	Brushed Gold (BG)		
YB5101BG	49.95	Toilet Tank Lever	24
YB5103BG	41.55	Double Robe Hook	24
<i>Pivoting</i> YB5108BG	76.35	Pivoting Paper Holder	6
YB5118BG	87.85	18" Towel Bar	6
YB5124BG	91.10	24" Towel Bar	6
YB5186BG	61.15	Towel Ring	6
NEW!	Polished Nickel (NL)		
<i>Ships Q2</i> YB5101NL	49.95	Toilet Tank Lever	-
YB5103NL	41.55	Double Robe Hook	-
<i>Pivoting</i> YB5108NL	76.35	Pivoting Paper Holder	-
YB5118NL	87.85	18" Towel Bar	-
YB5124NL	91.10	24" Towel Bar	-
YB5170NL	54.95	Wallmount Hairdryer Holder	-
YB5186NL	61.15	Towel Ring	-



YB5101 Toilet Tank Lever



YB5103 Double Robe Hook



YB5108 *Pivoting* Pivoting Paper Holder



YB5118 18" Towel Bar



YB5124 24" Towel Bar



YB5170 Wallmount Hairdryer Holder



YB5186 Towel Ring

VOSS™

GRAB BARS

PERFECTLY MATCHED to Moen® Align® faucets and bath accessories. ADA-compliant.



SecureMount™ Grab Bars are manufactured with an innovative flange design that makes it easy to connect to the stud at multiple points.

To install grab bars securely without studs, use SecureMount™ Anchors. Sold separately.

MODEL NUMBER	LIST PRICE EACH	DESCRIPTION	QTY
1-1/4" • Chrome (CH)			
YG5112CH	108.20	12" Grab Bar	6
YG5118CH	113.05	18" Grab Bar	6
YG5124CH	118.05	24" Grab Bar	6
1-1/4" • Brushed Nickel (BN)			
YG5112BN	130.65	12" Grab Bar	6
YG5118BN	137.05	18" Grab Bar	6
YG5124BN	147.80	24" Grab Bar	6
1-1/4" • Oil Rubbed Bronze (ORB)			
YG5112ORB	130.65	12" Grab Bar	6
YG5118ORB	137.05	18" Grab Bar	6
YG5124ORB	147.80	24" Grab Bar	6
NEW! 1-1/4" • Brushed Gold (BG)			
YG5112BG	130.65	12" Grab Bar	6
YG5118BG	137.05	18" Grab Bar	6
YG5124BG	147.80	24" Grab Bar	6
NEW! 1-1/4" • Polished Nickel (NL)			
YG5112NL	130.65	12" Grab Bar	-
YG5118NL	137.05	18" Grab Bar	-
YG5124NL	147.80	24" Grab Bar	-
SecureMount Anchors™			
SMA1005CH	21.20	SecureMount Anchors™ (1 pc Chrome Mounting Plates)	3
SMA1000WB	48.80	SecureMount Anchors™ (2 pc Old World Bronze Mounting Plates)	24

NEW!

NEW!

Ships Q2



YG5124
24" length Designer Grab Bar



Complies with Americans with Disabilities Act (ADA) specifications. SecureMount™ Grab Bars are tested to withstand 500 lb. pull when securely installed per instructions.



VOSS™

LIGHTING

MODEL NUMBER	LIST PRICE EACH	DESCRIPTION	QTY	
Chrome (CH)				
YB5161CH	157.55	One-Globe Light	2	
YB5162CH	220.55	Two-Globe Light	2	
YB5163CH	242.65	Three-Globe Light	2	
YB5164CH	330.80	Four-Globe Light	2	
Brushed Nickel (BN)				
YB5161BN	196.95	One-Globe Light	2	
YB5162BN	275.70	Two-Globe Light	2	
YB5163BN	303.25	Three-Globe Light	2	
YB5164BN	413.50	Four-Globe Light	2	
Oil Rubbed Bronze (ORB)				
YB5161ORB	196.95	One-Globe Light	2	
YB5162ORB	275.70	Two-Globe Light	2	
YB5163ORB	303.25	Three-Globe Light	2	
YB5164ORB	413.50	Four-Globe Light	2	
NEW!	Brushed Gold (BG)			
YB5161BG	196.95	One-Globe Light	2	
YB5162BG	275.70	Two-Globe Light	2	
YB5163BG	303.25	Three-Globe Light	2	
YB5164BG	413.50	Four-Globe Light	2	
NEW!	Polished Nickel (NL)			
Ships Q2	YB5161NL	196.95	One-Globe Light	-
	YB5162NL	275.70	Two-Globe Light	-
	YB5163NL	303.25	Three-Globe Light	-
	YB5164NL	413.50	Four-Globe Light	-
Replacement Globe				
YB5169	28.85	Replacement Globe Service Kit	3	



YB5161
One-Globe Light

YB5162
Two-Globe Light



YB5163
Three-Globe Light











YB5164
Four-Globe Light

YB5169
Replacement
Globe



Bulbs not included.

All lighting fixtures can be mounted facing either upward or downward.

	MODEL NUMBER	LIST PRICE	FINISH/ CONNECTION	CASE QTY
ONE-HANDLE BATHROOM FAUCET				
 <ul style="list-style-type: none"> • application: one hole • supply line length: flexible • connection size: 3/8" • connection type: compression • deck plate: sold separately • drain assembly: push-button • drain assembly type: spring loaded pop-up • red/blue markings: included   DURALAST™	6781	325.00	Chrome	3
		193148	40.35	Chrome
ONE-HANDLE ROMAN TUB WITH HANDSHOWER				
 <ul style="list-style-type: none"> • application: three hole • showerhead type: handshower • handshower functions: one-function • handshower flow rate: 1.75 gpm (6.65 L/min) max. • spout reach: 7.90" • red/blue markings included • valve sold separately  	T907	485.30	Chrome	3
	 <ul style="list-style-type: none"> • application: three hole • deck thickness: 1/8" to 2-5/8" rough deck • centre dimensions: 10" centre • test plug: included 	4791	282.65	1/2" CC
 <ul style="list-style-type: none"> • description: high flow thermostatic mixing valve • 1/2" FNPT (3/8" compression adapters) • listed to ASSE Standard 1070 • max. flow rate at 45 psi = 10 gpm • tub application 	104465	223.55	1/2" FNPT	12

HOW TO ORDER A COMPLETE ROMAN TUB FAUCET

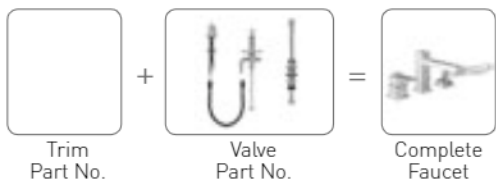









NOTES

 Moen® **M•PACT®** Common Valve System
DURALAST™ Duralast® Cartridge



NEW! KYVOS™ Posi-Temp® Showering





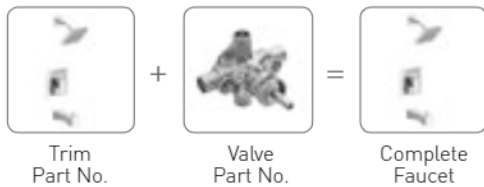

		MODEL NUMBER	LIST PRICE	FINISH/ CONNECTION	CASE QTY
POSI-TEMP® TUB/SHOWER					
  <ul style="list-style-type: none"> • showerhead functions: six-functions • showerhead type: eco-performance showerhead • showerhead size: 5" diameter spray head • showerhead flow rate: 1.75 gpm (6.65 L/min) max. • spout length: 7" • spout connection type: slip fit • tub spout type: diverter • red/blue markings: included • valve sold separately   		T2783EP	244.05	Chrome	3
 		2510	152.20	1/2" IPS	6
		2520	152.20	1/2" CC	6
 		2570	194.75	1/2" CC	6
		2590	194.75	1/2" IPS	6

HOW TO ORDER A COMPLETE TUB/SHOWER FAUCET



NOTES

 Moen® **M•PACT**® Common Valve System

	MODEL NUMBER	LIST PRICE	FINISH/ CONNECTION	CASE QTY
POSI-TEMP® SHOWER ONLY				
 <ul style="list-style-type: none"> • showerhead functions: six-functions • showerhead type: eco-performance showerhead • showerhead size: 5" diameter spray head • showerhead flow rate: 1.75 gpm (6.65 L/min) max. • red/blue markings: included • valve sold separately 	T2782EP	169.10	Chrome	3
 <ul style="list-style-type: none"> • ports: four • adjustable temp limit stop: included 	2510 2520	152.20	1/2" IPS 1/2" CC	6 6
 <ul style="list-style-type: none"> • ports: four • adjustable temp limit stop: included • quarter turn stops: included 	2570 2590	194.75	1/2" CC 1/2" IPS	6 6













HOW TO ORDER A COMPLETE SHOWER FAUCET



NOTES

 Moen® M•PACT® Common Valve System

NEW! KYVOS™ Posi-Temp® Showering

	MODEL NUMBER	LIST PRICE	FINISH/ CONNECTION	CASE QTY
POSI-TEMP® VALVE TRIM				
 <ul style="list-style-type: none"> • red/blue markings: included • valve sold separately 	T2781	100.20	Chrome	3
 <ul style="list-style-type: none"> • ports: four • adjustable temp limit stop: included 	2510	152.20	1/2" IPS	6
 <ul style="list-style-type: none"> • ports: four • adjustable temp limit stop: included 	2520	152.20	1/2" CC	6
 <ul style="list-style-type: none"> • ports: four • adjustable temp limit stop: included • quarter turn stops: included 	2570	194.75	1/2" CC	6
 <ul style="list-style-type: none"> • ports: four • adjustable temp limit stop: included • quarter turn stops: included 	2590	194.75	1/2" IPS	6

VICHY™

HOW TO ORDER A COMPLETE SHOWER FAUCET



NOTES

 Moen® **M•PACT®** Common Valve System

NEW! KYVOS™ Coordinating Bath Accessories

Moen® makes it easy to coordinate the entire style and look of the bathroom. Our Kyvos™ bath accessories perfectly match the style and finish of our Kyvos™ faucets. Total coordination of the bath has never been easier.

MODEL NUMBER	LIST PRICE EACH	DESCRIPTION	QTY
Chrome (CH)			
BP3703CH	44.05	Single Robe Hook	24
<i>Pivoting</i> BP3708CH	65.35	Pivoting Paper Holder	6
BP3718CH	98.90	18" Towel Bar	6
BP3724CH	100.65	24" Towel Bar	6
BP3786CH	67.00	Hand Towel Bar	6



NEW!
BP3703
Single Robe Hook



NEW!
BP3708 *Pivoting*
Pivoting Paper Holder



NEW!
BP3718
18" Towel Bar



NEW!
BP3824
24" Towel Bar















NEW!
BP3786
Hand Towel Bar



BELFIELD™ Bathroom Faucets

All Brushed Nickel faucet components feature the LifeShine® Non-Tarnish Finish.

	MODEL NUMBER	LIST PRICE	FINISH/ CONNECTION	CASE QTY
ONE-HANDLE BATHROOM FAUCET				
 <ul style="list-style-type: none"> • application: one or three hole • supply line length: flexible • connection size: 3/8" • connection type: compression • deckplate: included • drain assembly: metal • drain assembly type: lift rod   DURALAST*	6402	326.50	Chrome	3
	6402BN	539.50	Brushed Nickel	3
	6402ORB	539.50	Oil Rubbed Bronze	3
	NEW! 6402NL*	539.50	Polished Nickel	-
TWO-HANDLE CENTRESET BATHROOM FAUCET				
 <ul style="list-style-type: none"> • application: three hole • centre dimensions: 4" centre • connection size: 1/2" • connection type: IPS • drain assembly: metal • drain assembly type: lift rod  	6401	313.80	Chrome	3
	6401BN	500.60	Brushed Nickel	3
	6401ORB	500.60	Oil Rubbed Bronze	3
	NEW! 6401NL*	500.60	Polished Nickel	-
TWO-HANDLE WIDESPREAD BATHROOM FAUCET				
 <ul style="list-style-type: none"> • application: three hole • centre dimensions: 8" - 16" centre • drain assembly: metal • drain assembly type: lift rod • valve: sold separately   	T6405	352.45	Chrome	3
	T6405BN	564.05	Brushed Nickel	3
	T6405ORB	564.05	Oil Rubbed Bronze	3
	NEW! T6405NL*	564.05	Polished Nickel	-
 <ul style="list-style-type: none"> • application: three hole • centre dimensions: 8" - 16" centre • drain assembly: metal • drain assembly type: lift rod  DURALOCK* DURALAST*	9000	148.70	1/2" IPS	6

BELFIELD™

HOW TO ORDER A COMPLETE BATHROOM FAUCET

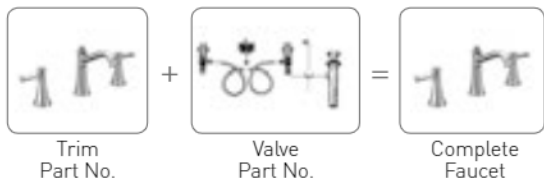





NOTES

-  Moen® **M•PACT**® Common Valve System
- DURALOCK**™ Duralock™ Quick Connections
- DURALAST**™ Duralast™ Cartridge
- *Ships Q2

BELFIELD™ Tub Fillers

All Brushed Nickel faucet components feature the LifeShine® Non-Tarnish Finish.

	MODEL NUMBER	LIST PRICE	FINISH/ CONNECTION	CASE QTY
FREESTANDING TUB FILLER				
<p>NEW! Ships Q3</p>  <ul style="list-style-type: none"> • application: one hole • showerhead type: handshower • handshower functions: one-function • handshower flow rate: 1.75 gpm (6.65 L/min) max. • spout reach: 8.75" • mounting kit: sold separately  	9025	1,821.70	Chrome	1
	9025BN	2,692.25	Brushed Nickel	-
	9025NL	2,692.25	Polished Nickel	-
	9025ORB	2,692.25	Oil Rubbed Bronze	-
 <ul style="list-style-type: none"> • description: single riser floor joist mounting kit • application: one hole • quarter turn stops: included 	TS50100	336.65	1/2" CC, NPT	2



HOW TO ORDER A COMPLETE FREESTANDING TUB FILLER FAUCET













NOTES

 Moen® **M•PACT**® Common Valve System

BELFIELD™ Roman Tub

All Brushed Nickel faucet components feature the LifeShine® Non-Tarnish Finish.

	MODEL NUMBER	LIST PRICE	FINISH/ CONNECTION	CASE QTY	
TWO-HANDLE ROMAN TUB					
 <ul style="list-style-type: none"> • application: three hole • spout reach: 7.50" • valve: sold separately  	T9023 T9023BN T9023ORB  T9023NL*	413.60 644.10 644.10 644.10	Chrome Brushed Nickel Oil Rubbed Bronze Polished Nickel	3 3 3 -	
	 <ul style="list-style-type: none"> • application: three hole • deck thickness: 1/8" to 3-3/8" rough-in deck • centre dimensions: adjustable • adjustable spout shank: included • test plug: included 	4792	188.00	1/2" CC	6
	 <ul style="list-style-type: none"> • application: three hole • deck thickness: 1/8" to 1-7/8" rough-in deck • centre dimensions: 10" centre • non-adjustable spout shank: included • test plug: included 	4796 4798	179.95 179.95	1/2" CC 1/2" Crimp ring PEX, Cold Expansion PEX	6 6
		 <ul style="list-style-type: none"> • description: high flow thermostatic mixing valve • 1/2" FNPT (3/8" compression adapters) • listed to ASSE Standard 1070 • max. flow rate at 45 psi = 10 gpm • tub application 	104465	223.55	1/2" FNPT
 <ul style="list-style-type: none"> • description: PEX transition fittings (2) and clips • connections: adapts standard 1/2" PEX barb to 1/2" PEX cold expansion 	140715	11.35	1/2" PEX	200	

BELFIELD™

HOW TO ORDER A COMPLETE ROMAN TUB FAUCET

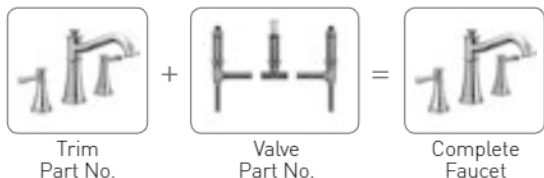







NOTES

 Moen® **M•PACT®** Common Valve System
 *Ships Q2

BELFIELD™ Roman Tubs

All Brushed Nickel faucet components feature the LifeShine® Non-Tarnish Finish.

	MODEL NUMBER	LIST PRICE	FINISH/ CONNECTION	CASE QTY
TWO-HANDLE ROMAN TUB WITH HANDSHOWER				
 <ul style="list-style-type: none"> • application: four hole • showerhead type: handshower • handshower flow rate: 1.75 gpm [6.65 L/min] max. • spray functions: one-function • spout reach: 7.50" • valve: sold separately  	T9024	657.90	Chrome	3
	T9024BN	1,078.50	Brushed Nickel	3
	T9024ORB	1,078.50	Oil Rubbed Bronze	3
	T9024NL*	1,078.50	Polished Nickel	-
 <ul style="list-style-type: none"> • application: four hole • deck thickness: 1/8" to 2-5/8" deck • centre dimensions: 10" centre • non-adjustable spout shank: included • test plug: included 	9796	358.95	1/2" CC	6
	9797	358.95	1/2" CPVC, PEX	6
 <ul style="list-style-type: none"> • description: high flow thermostatic mixing valve • 1/2" FNPT (3/8" compression adapters) • listed to ASSE Standard 1070 • max. flow rate at 45 psi = 10 gpm • tub application 	104465	223.55	1/2" FNPT	12
 <ul style="list-style-type: none"> • description: PEX transition fittings (2) and clips • connections: adapts standard 1/2" PEX barb to 1/2" PEX cold expansion 	140715	11.35	1/2" PEX	200

BELFIELD™

HOW TO ORDER A COMPLETE ROMAN TUB FAUCET

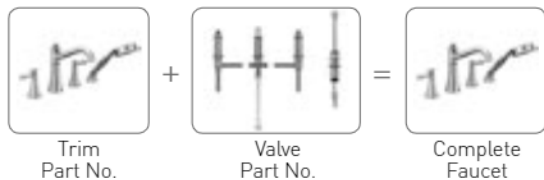

NOTES

 Moen® **M•PACT®** Common Valve System
 *Ships Q2

BELFIELD™ 3/4" Thermostatic Showering

All Brushed Nickel faucet components feature the LifeShine® Non-Tarnish Finish.

		MODEL NUMBER	LIST PRICE	FINISH/ CONNECTION	CASE QTY
EXACTTEMP® VALVE ONLY					
 <ul style="list-style-type: none"> requires: separate volume control valve valve: sold separately 		T4411	280.00	Chrome	3
		T4411BN	472.30	Brushed Nickel	3
		T4411NL*	472.30	Polished Nickel	3
		T4411ORB	472.30	Oil Rubbed Bronze	-
 <ul style="list-style-type: none"> description: thermostatic rough-in valve ports: four adjustable temp limit stop: included check stops: included 		S3371	626.05	3/4" IPS	6
	EXACTTEMP® VOLUME CONTROL VALVE ONLY				
 <ul style="list-style-type: none"> valve: sold separately 		T4412	129.45	Chrome	6
		T4412BN	212.85	Brushed Nickel	6
		T4412NL*	212.85	Polished Nickel	6
		T4412ORB	212.85	Oil Rubbed Bronze	6
 <ul style="list-style-type: none"> description: volume control rough-in valve includes: volume control 		S3600	141.15	3/4" IPS	12

BELFIELD™

HOW TO ORDER A COMPLETE EXACTTEMP® VALVE

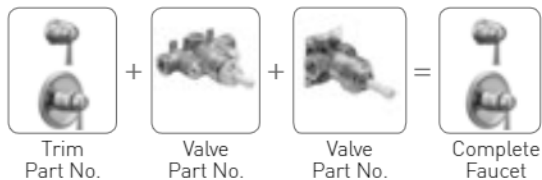







NOTES

 Moen® **M•PACT®** Common Valve System
*Ships Q2

BELFIELD™ Transfer Valve Shower Spa Components

All Brushed Nickel faucet components feature the LifeShine® Non-Tarnish Finish.

	MODEL NUMBER	LIST PRICE	FINISH/ CONNECTION	CASE QTY
2/3 FUNCTION TRANSFER VALVE ONLY				
 <ul style="list-style-type: none"> • use with 3372 or 3375 transfer valve • valve: sold separately  	T4301	128.90	Chrome	12
	T4301BN	196.20	Brushed Nickel	12
	T4301ORB	196.20	Oil Rubbed Bronze	12
	T4301NL*	196.20	Polished Nickel	-
  <ul style="list-style-type: none"> • type of function: two independent one shared • must be used with: Posi-Temp® or Moentrol® valve 	3372	188.30	1/2" CC	12
	  <ul style="list-style-type: none"> • type of function: two independent functions • must be used with: Posi-Temp® or Moentrol® valve 	3375	188.30	1/2" CC



HOW TO ORDER A COMPLETE TRANSFER VALVE

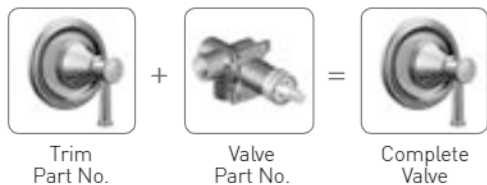







NOTES

-  Moen® **M•PACT®** Common Valve System
- DURALAST** Duralast® Cartridge
- *Ships Q2

BELFIELD™ Moentrol® Showering

All Brushed Nickel faucet components feature the LifeShine® Non-Tarnish Finish.

		MODEL NUMBER	LIST PRICE	FINISH/ CONNECTION	CASE QTY
MOENTROL® TUB/SHOWER					
 <ul style="list-style-type: none"> • showerhead type: showerhead sold separately • spout length: 7-3/4" • spout connection type: slip fit • tub spout type: diverter • valve: sold separately 		T3313NH	272.65	Chrome	3
		T3313NHBN	494.95	Brushed Nickel	3
		T3313NHORB	494.95	Oil Rubbed Bronze	3
		T3313NHNL*	494.95	Polished Nickel	-
					
 <ul style="list-style-type: none"> • description: pressure balanced valve with volume control • ports: four • adjustable temp limit stop: included • checks: included • includes: volume control 		3510	210.05	1/2" IPS	6
		3520	210.05	1/2" CC	6
					
 <ul style="list-style-type: none"> • description: pressure balanced valve with volume control • ports: four • adjustable temp limit stop: included • check stops: included • includes: volume control 		3570	232.40	1/2" CC	6
					

BELFIELD™

HOW TO ORDER A COMPLETE TUB/SHOWER FAUCET

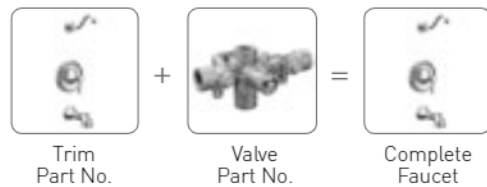













NOTES

 Moen® **M•PACT®** Common Valve System
*Ships Q2

BELFIELD™ Moentrol® Showering

All Brushed Nickel faucet components feature the LifeShine® Non-Tarnish Finish.

		MODEL NUMBER	LIST PRICE	FINISH/ CONNECTION	CASE QTY
MOENTROL® SHOWER ONLY					
 <ul style="list-style-type: none"> • showerhead type: showerhead sold separately • valve: sold separately 		T3312NH	174.95	Chrome	3
		T3312NHBN	390.55	Brushed Nickel	3
		T3312NHORB	390.55	Oil Rubbed Bronze	3
		T3312NHNL*	390.55	Polished Nickel	-
					
 <ul style="list-style-type: none"> • description: pressure balanced valve with volume control • ports: four • adjustable temp limit stop: included • checks: included • includes: volume control 		3510	210.05	1/2" IPS	6
		3520	210.05	1/2" CC	6
					
 <ul style="list-style-type: none"> • description: pressure balanced valve with volume control • ports: four • adjustable temp limit stop: included • check stops: included • includes: volume control 		3570	232.40	1/2" CC	6
					

MOENTROL® VALVE ONLY					
 <ul style="list-style-type: none"> • valve: sold separately 		T3311	159.60	Chrome	3
		T3311BN	347.05	Brushed Nickel	3
		T3311ORB	347.05	Oil Rubbed Bronze	3
		T3311NL*	347.05	Polished Nickel	-
					
 <ul style="list-style-type: none"> • description: pressure balanced valve with volume control • ports: four • adjustable temp limit stop: included • checks: included • includes: volume control 		3510	210.05	1/2" IPS	6
		3520	210.05	1/2" CC	6
					
 <ul style="list-style-type: none"> • description: pressure balanced valve with volume control • ports: four • adjustable temp limit stop: included • check stops: included • includes: volume control 		3570	232.40	1/2" CC	6
					

HOW TO ORDER A COMPLETE SHOWER FAUCET

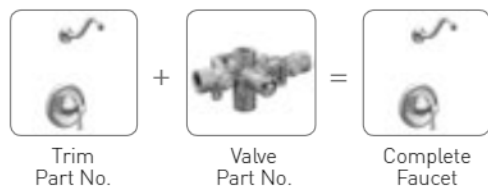

NOTES









 Moen® **M•PACT®** Common Valve System

*Ships Q2



BELFIELD™ Posi-Temp® Showering

All Brushed Nickel faucet components feature the LifeShine® Non-Tarnish Finish.

		MODEL NUMBER	LIST PRICE	FINISH/ CONNECTION	CASE QTY
POSI-TEMP® TUB/SHOWER					
	<ul style="list-style-type: none"> • showerhead functions: one-function • showerhead type: standard • showerhead size: 7" diameter spray head • showerhead flow rate: 2.5 gpm (9.5 L/min) max. • spout length: 7-3/4" • spout connection type: slip fit • tub spout type: diverter • valve: sold separately 	T2313	266.35	Chrome	4
		T2313BN	441.70	Brushed Nickel	4
		T2313ORB	441.70	Oil Rubbed Bronze	4
		T2313NL*	441.70	Polished Nickel	-
	<ul style="list-style-type: none"> • showerhead functions: one-function • showerhead type: standard • showerhead size: 7" diameter spray head • showerhead flow rate: 1.75 gpm (6.65 L/min) max. • spout length: 7-3/4" • spout connection type: slip fit • tub spout type: diverter • valve: sold separately 	T2313EP	266.35	Chrome	4
		T2313EPBN	441.70	Brushed Nickel	4
		T2313EPORB	441.70	Oil Rubbed Bronze	4
		T2313EPNL*	441.70	Polished Nickel	-
	<ul style="list-style-type: none"> • description: pressure balanced cycling valve • ports: four • adjustable temp limit stop: included 	2510	152.20	1/2" IPS	6
		2520	152.20	1/2" CC	6
	<ul style="list-style-type: none"> • description: pressure balanced cycling valve • ports: four • adjustable temp limit stop: included • quarter turn stops: included 	2570	194.75	1/2" CC	6
		2590	194.75	1/2" IPS	6

BELFIELD™

HOW TO ORDER A COMPLETE TUB/SHOWER FAUCET













NOTES

 Moen® **M•PACT®** Common Valve System
*Ships Q2

BELFIELD™ Posi-Temp® Showering

All Brushed Nickel faucet components feature the LifeShine® Non-Tarnish Finish.

		MODEL NUMBER	LIST PRICE	FINISH/ CONNECTION	CASE QTY
POSI-TEMP® SHOWER ONLY					
	<ul style="list-style-type: none"> • showerhead functions: one-function • showerhead type: standard • showerhead size: 7" diameter spray head • showerhead flow rate: 2.5 gpm (9.5 L/min) max. • valve: sold separately 	T2312	208.20	Chrome	4
		T2312BN	359.50	Brushed Nickel	4
		T2312ORB	359.50	Oil Rubbed Bronze	4
		NEW! T2312NL*	359.50	Polished Nickel	-
	 				
	<ul style="list-style-type: none"> • showerhead functions: one-function • showerhead type: standard • showerhead size: 7" diameter spray head • showerhead flow rate: 1.75 gpm (6.65 L/min) max. • valve: sold separately 	T2312EP	208.20	Chrome	4
		T2312EPBN	359.50	Brushed Nickel	4
		T2312EPORB	359.50	Oil Rubbed Bronze	4
		NEW! T2312EPNL*	359.50	Polished Nickel	-
	  				
	<ul style="list-style-type: none"> • description: pressure balanced cycling valve • ports: four • adjustable temp limit stop: included 	2510	152.20	1/2" IPS	6
		2520	152.20	1/2" CC	6
					
	<ul style="list-style-type: none"> • description: pressure balanced cycling valve • ports: four • adjustable temp limit stop: included • quarter turn stops: included 	2570	194.75	1/2" CC	6
		2590	194.75	1/2" IPS	6
					



HOW TO ORDER A COMPLETE SHOWER FAUCET

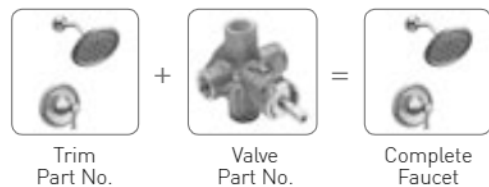







NOTES

-  Moen® **M•PACT**® Common Valve System
- IMMERSION** Immersion® Rainshower
- *Ships Q2

BELFIELD™ Posi-Temp® Showering

All Brushed Nickel faucet components feature the LifeShine® Non-Tarnish Finish.

		MODEL NUMBER	LIST PRICE	FINISH/ CONNECTION	CASE QTY
POSI-TEMP® VALVE ONLY					
 <ul style="list-style-type: none"> valve: sold separately  		T2311	142.25	Chrome	3
		T2311BN	268.75	Brushed Nickel	3
		T2311ORB	268.75	Oil Rubbed Bronze	3
		NEW! T2311NL*	268.75	Polished Nickel	-
 		2510	152.20	1/2" IPS	6
	<ul style="list-style-type: none"> description: pressure balanced cycling valve ports: four adjustable temp limit stop: included 	2520	152.20	1/2" CC	6
 		2570	194.75	1/2" CC	6
	<ul style="list-style-type: none"> description: pressure balanced cycling valve ports: four adjustable temp limit stop: included quarter turn stops: included 	2590	194.75	1/2" IPS	6

BELFIELD™

HOW TO ORDER A COMPLETE VALVE



NOTES

 Moen® **M•PACT®** Common Valve System
*Ships Q2

BELFIELD™ Perfectly Matched Bath Accessories

Moen makes it easy to coordinate the entire style and look of the bathroom. Our Belfield™ bath accessories perfectly match the style and finish of our Belfield™ faucets. Total coordination of the bath has never been easier.

MODEL NUMBER	LIST PRICE EACH	DESCRIPTION	5/8-in Round Bar	QTY
Chrome (CH)				
YB6401CH	49.00	Tank Lever		24
YB6403CH	43.65	Double Robe Hook		24
 YB6408CH	82.65	Pivoting Paper Holder		6
YB6418CH	92.60	18" Towel Bar		6
YB6422CH	122.55	24" Double Towel Bar		6
YB6424CH	95.40	24" Towel Bar		6
YB6486CH	64.90	Hand Towel Bar		6
Brushed Nickel (BN)				
YB6401BN	56.25	Tank Lever		24
YB6403BN	49.50	Double Robe Hook		24
 YB6408BN	91.10	Pivoting Paper Holder		6
YB6418BN	104.95	18" Towel Bar		6
YB6422BN	139.95	24" Double Towel Bar		6
YB6424BN	108.95	24" Towel Bar		6
YB6486BN	73.40	Hand Towel Bar		6
Oil Rubbed Bronze (ORB)				
YB6401ORB	56.25	Tank Lever		24
YB6403ORB	49.50	Double Robe Hook		24
 YB6408ORB	91.10	Pivoting Paper Holder		6
YB6418ORB	104.95	18" Towel Bar		6
YB6422ORB	139.95	24" Double Towel Bar		6
YB6424ORB	108.95	24" Towel Bar		6
YB6486ORB	73.40	Hand Towel Bar		6
Polished Nickel (NL)				
 YB6401NL	56.25	Tank Lever		-
Ships Q2 YB6403NL	49.50	Double Robe Hook		-
YB6408NL	91.10	Pivoting Paper Holder		-
YB6418NL	104.95	18" Towel Bar		-
YB6422NL	139.95	24" Double Towel Bar		-
YB6424NL	108.95	24" Towel Bar		-
YB6486NL	73.40	Hand Towel Bar		-



YB6401 Tank Lever



YB6403 Double Robe Hook



YB6408 Pivoting Paper Holder



YB6418 18" Towel Bar



YB6422 24" Double Towel Bar



YB6424 24" Towel Bar



YB6486 Hand Towel Bar



GRAB BARS

PERFECTLY MATCHED to Moen® BELFIELD™ faucets and bath accessories. ADA-compliant.



SecureMount™ Grab Bars are manufactured with an innovative flange design that makes it easy to connect to the stud at multiple points.

To install grab bars securely without studs, use SecureMount™ Anchors. Sold separately.



YG6424 24" length Grab Bar



Complies with Americans with Disabilities Act (ADA) specifications. SecureMount™ Grab Bars are tested to withstand 500 lb. pull when securely installed per instructions.

List price is per each (unless otherwise noted). Product can be ordered by case quantity or individually.

MODEL NUMBER	LIST PRICE EACH	DESCRIPTION	QTY
1-1/4" • Chrome (CH)			
YG6412CH	128.65	12" Grab Bar	6
YG6418CH	144.55	18" Grab Bar	6
YG6424CH	159.35	24" Grab Bar	6
1-1/4" • Brushed Nickel (BN)			
YG6412BN	164.90	12" Grab Bar	6
YG6418BN	184.30	18" Grab Bar	6
YG6424BN	203.25	24" Grab Bar	3
1-1/4" • Oil Rubbed Bronze (ORB)			
YG6412ORB	164.90	12" Grab Bar	6
YG6418ORB	184.30	18" Grab Bar	6
YG6424ORB	203.25	24" Grab Bar	6
1-1/4" • Polished Nickel (NL)			
 YG6412NL	164.90	12" Grab Bar	-
Ships Q2 YG6418NL	184.30	18" Grab Bar	-
YG6424NL	203.25	24" Grab Bar	-
1-1/4" • Matte Black (BL)			
 YG6412BL	164.90	12" Grab Bar	-
Ships Q2 YG6418BL	184.30	18" Grab Bar	-
YG6424BL	203.25	24" Grab Bar	-

BELFIELD™ Perfectly Matched Bath Accessories



BELFIELD™

LIGHTING

MODEL NUMBER	LIST PRICE EACH	DESCRIPTION	QTY
Chrome (CH)			
YB6461CH	189.10	One Globe Light	1
YB6462CH	264.65	Two Globe Light	1
YB6463CH	291.10	Three Globe Light	1
YB6464CH	397.05	Four Globe Light	1
Brushed Nickel (BN)			
YB6461BN	236.40	One Globe Light	1
YB6462BN	330.80	Two Globe Light	1
YB6463BN	363.90	Three Globe Light	1
YB6464BN	496.20	Four Globe Light	1
Oil Rubbed Bronze (ORB)			
YB6461ORB	236.40	One Globe Light	1
YB6462ORB	330.80	Two Globe Light	1
YB6463ORB	363.90	Three Globe Light	1
YB6464ORB	496.20	Four Globe Light	1
NEW! Polished Nickel (NL)			
Ships Q2 YB6461NL	236.40	One Globe Light	-
YB6462NL	330.80	Two Globe Light	-
YB6463NL	363.90	Three Globe Light	-
YB6464NL	496.20	Four Globe Light	-
NEW! Matte Black (BL)			
Ships Q2 YB6461BL	236.40	One Globe Light	-
YB6462BL	330.80	Two Globe Light	-
YB6463BL	363.90	Three Globe Light	-
YB6464BL	496.20	Four Globe Light	-
Replacement Globe			
YB6469	28.85	Replacement Globe	3



YB6461
One Globe Light

YB6462
Two Globe Light



YB6463
Three Globe Light



YB6464
Four Globe Light

YB6469
Replacement Globe









Bulbs not included.

All BELFIELD™ lighting fixtures can be mounted facing either upward or downward. List price is per each (unless otherwise noted). Product can be ordered by case quantity or individually.

KINGSLEY® Bathroom Faucets

All Brushed Nickel faucet components feature the LifeShine® Non-Tarnish Finish.

	MODEL NUMBER	LIST PRICE	FINISH/ CONNECTION	CASE QTY
ONE-HANDLE BATHROOM FAUCET				
 <ul style="list-style-type: none"> • application: one or three hole • supply line length: flexible • connection size: 3/8" • connection type: compression • deck plate: included • drain assembly: metal • drain assembly type: lift rod   DURALAST®	6102	326.50	Chrome	3
	6102BN	539.50	Brushed Nickel	3
	6102ORB	539.50	Oil Rubbed Bronze	3
	6102WR	539.50	Wrought Iron	3
	<hr/>			
 <ul style="list-style-type: none"> • vessel extension kit • includes: two 3" extensions • includes: parts to convert to grid drain 	A1616	138.45	Chrome	6
	A1616BN	224.65	Brushed Nickel	6
	A1616ORB	224.65	Oil Rubbed Bronze	6
	A1616WR	224.65	Wrought Iron	6
	<hr/>			
TWO-HANDLE BATHROOM FAUCET				
 <ul style="list-style-type: none"> • application: three hole • centre dimensions: 4" centre • connection size: 1/2" • connection type: IPS • drain assembly: metal • drain assembly type: lift rod  	6121	356.55	Chrome	3
	6121BN	575.35	Brushed Nickel	3
	6121ORB	575.35	Oil Rubbed Bronze	3
	6121WR	575.35	Wrought Iron	3















NOTES

DURALAST® Duralast® Cartridge

KINGSLEY® Bathroom Faucets

All Brushed Nickel faucet components feature the LifeShine® Non-Tarnish Finish.

		MODEL NUMBER	LIST PRICE	FINISH/ CONNECTION	CASE QTY
TWO-HANDLE WIDESPREAD BATHROOM FAUCET					
 <ul style="list-style-type: none"> • application: three hole • centre dimensions: 8" - 16" centre • drain assembly: metal • drain assembly type: lift rod • valve sold separately   		T6125	412.15	Chrome	3
		T6125BN	680.15	Brushed Nickel	3
		T6125ORB	680.15	Oil Rubbed Bronze	3
		T6125WR	680.15	Wrought Iron	3
TWO-HANDLE WALL MOUNT BATHROOM FAUCET					
 <ul style="list-style-type: none"> • application: three hole • centre dimensions: 8" - 16" centre • drain assembly: metal • drain assembly type: lift rod  DURALOCK® DURALAST®		9000	148.70	1/2" IPS	6
	TWO-HANDLE WALL MOUNT BATHROOM FAUCET				
	 <ul style="list-style-type: none"> • application: three hole • centre dimensions: 8" centre • spout reach: 7.00" • drain assembly: 140780 sold separately • valve sold separately   		T6107	324.60	Chrome
		T6107BN	537.55	Brushed Nickel	3
		T6107ORB	537.55	Oil Rubbed Bronze	3
 <ul style="list-style-type: none"> • application: three hole • centre dimensions: 8" centre • drain assembly: 140780 sold separately • includes: mounting brackets 		9700	219.75	1/2" CC	3
	 <ul style="list-style-type: none"> • drain assembly: metal • drain assembly type: spring loaded pop-up 		140780	94.40	Chrome
		140780BN	136.05	Brushed Nickel	12
		140780ORB	136.05	Oil Rubbed Bronze	12

KINGSLEY®

HOW TO ORDER A COMPLETE BATHROOM FAUCET

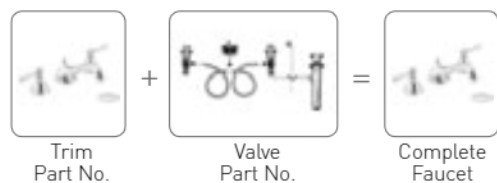









NOTES

-  Moen® **M•PACT®** Common Valve System
- DURALOCK** Duralock™ Quick Connections
- DURALAST** Duralast® Cartridge

KINGSLEY® Roman Tub

All Brushed Nickel faucet components feature the LifeShine® Non-Tarnish Finish.

	MODEL NUMBER	LIST PRICE	FINISH/ CONNECTION	CASE QTY
TWO-HANDLE ROMAN TUB				
 <ul style="list-style-type: none"> • application: three hole • spout reach: 9.00" • valve sold separately  	T920	509.65	Chrome	3
	T920BN	755.85	Brushed Nickel	3
	T920ORB	755.85	Oil Rubbed Bronze	3
	T920WR	755.85	Wrought Iron	3
 <ul style="list-style-type: none"> • application: three hole • deck thickness: 1/8" to 3-3/8" rough deck • centre dimensions: adjustable • adjustable spout shank: included • test plug: included 	4792	188.00	1/2" CC	6
	 <ul style="list-style-type: none"> • application: three hole • deck thickness: 1/8" to 1-7/8" deck • centre dimensions: 10" centre • non-adjustable spout shank: included • test plug: included 	4796	179.95	1/2" CC
		4798	179.95	1/2" PEX, Cold Expansion PEX
 <ul style="list-style-type: none"> • description: high flow thermostatic mixing valve • 1/2" FNPT (3/8" compression adapters) • listed to ASSE Standard 1070 • max. flow rate at 45 psi = 10 gpm • tub application 	104465	223.55	1/2" FNPT	12
 <ul style="list-style-type: none"> • description: PEX transition fittings (2) and clips • adapts standard 1/2" PEX barb to 1/2" PEX cold expansion connections 	140715	11.35	1/2" PEX	200



HOW TO ORDER A COMPLETE ROMAN TUB FAUCET

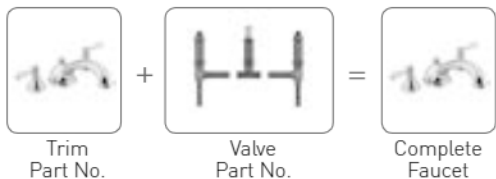







NOTES

 Moen® **M•PACT®** Common Valve System

KINGSLEY® Roman Tubs

All Brushed Nickel faucet components feature the LifeShine® Non-Tarnish Finish.

	MODEL NUMBER	LIST PRICE	FINISH/ CONNECTION	CASE QTY
TWO-HANDLE ROMAN TUB WITH HANDSHOWER				
 <ul style="list-style-type: none"> • application: four hole • showerhead type: handshower • handshower functions: one-function • handshower flow rate: 1.75 gpm [6.65 L/min] max. • spout reach: 9.00" • valve sold separately 	T922	788.00	Chrome	3
	T922BN	1,183.35	Brushed Nickel	3
	T922ORB	1,183.35	Oil Rubbed Bronze	3
 <ul style="list-style-type: none"> • application: four hole • deck thickness: 1/8" to 2-5/8" deck • centre dimensions: 10" centre • non-adjustable spout shank: included • test plug: included 	9796	358.95	1/2" CC	6
	9797	358.95	1/2" CPVC, PEX	6
 <ul style="list-style-type: none"> • description: high flow thermostatic mixing valve • 1/2" FNPT (3/8" compression adapters) • listed to ASSE Standard 1070 • max. flow rate at 45 psi = 10 gpm • tub application 	104465	223.55	1/2" FNPT	12
 <ul style="list-style-type: none"> • description: PEX transition fittings (2) and clips • adapts standard 1/2" PEX barb to 1/2" PEX cold expansion connections 	140715	11.35	1/2" PEX	200

KINGSLEY®

HOW TO ORDER A COMPLETE ROMAN TUB FAUCET

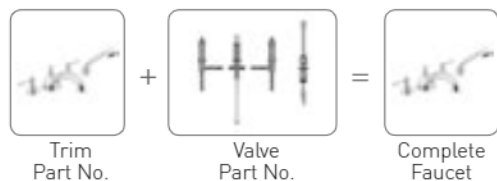











NOTES

 Moen® **M•PACT**® Common Valve System

KINGSLEY® Moentrol Transfer Valve Shower Spa Components

All Brushed Nickel faucet components feature the LifeShine® Non-Tarnish Finish.

	MODEL NUMBER	LIST PRICE	FINISH/ CONNECTION	CASE QTY
MOENTROL® WITH TRANSFER VALVE TRIM				
 <ul style="list-style-type: none"> valve sold separately 	T4111	210.10	Chrome	3
	T4111BN	317.10	Brushed Nickel	3
	T4111ORB	317.10	Oil Rubbed Bronze	3
				
 <ul style="list-style-type: none"> ports: four; two outlets type of function: two discrete one shared adjustable limit stop: included not recommended: for tub spout application 	3320	352.60	1/2" IPS inlets/CC outlets	6
	3330	352.60	1/2" CC	6
				

TRANSFER VALVE TRIM				
 <ul style="list-style-type: none"> valve sold separately 	T4311	128.90	Chrome	6
	T4311BN	196.20	Brushed Nickel	6
	T4311ORB	196.20	Oil Rubbed Bronze	6
				
 <ul style="list-style-type: none"> type of function: two independent one shared must be used with: Posi-Temp or Moentrol valve 	3372	188.30	1/2" CC	12
	3375	188.30	1/2" CC	12
				
 <ul style="list-style-type: none"> type of function: two discrete must be used with: Posi-Temp or Moentrol valve 	3375	188.30	1/2" CC	12
	3375	188.30	1/2" CC	12
				

HOW TO ORDER A COMPLETE MOENTROL WITH TRANSFER VALVE



HOW TO ORDER A COMPLETE TRANSFER VALVE



NOTES

 Moen® **M•PACT®** Common Valve System

KINGSLEY®

KINGSLEY® Moentrol® Showering

All Brushed Nickel faucet components feature the LifeShine® Non-Tarnish Finish.

		MODEL NUMBER	LIST PRICE	FINISH/ CONNECTION	CASE QTY
MOENTROL® TUB/SHOWER					
 <ul style="list-style-type: none"> • showerhead functions: one-function • showerhead type: standard • showerhead size: 4-3/8" diameter spray head • showerhead flow rate: 2.5 gpm (9.5 L/min) max. • spout length: 5 1/2" • spout connection type: slip fit • tub spout type: diverter • valve sold separately 		T3113	320.75	Chrome	3
		T3113BN	562.90	Brushed Nickel	3
		T3113ORB	562.90	Oil Rubbed Bronze	3
  <ul style="list-style-type: none"> • ports: four • adjustable temperature limit stop: included • includes: volume control 		3510	210.05	1/2" IPS	6
		3520	210.05	1/2" CC	6
  <ul style="list-style-type: none"> • ports: four • adjustable temperature limit stop: included • includes: volume control • check stops: included 		3570	232.40	1/2" CC	6
MOENTROL® SHOWER ONLY					
 <ul style="list-style-type: none"> • showerhead functions: one-function • showerhead type: standard • showerhead size: 4-3/8" diameter spray head • showerhead flow rate: 2.5 gpm (9.5 L/min) max. • valve sold separately 		T3112	223.00	Chrome	3
		T3112BN	458.55	Brushed Nickel	3
		T3112ORB	458.55	Oil Rubbed Bronze	3
  <ul style="list-style-type: none"> • ports: four • adjustable temperature limit stop: included • includes: volume control 		3510	210.05	1/2" IPS	6
		3520	210.05	1/2" CC	6
  <ul style="list-style-type: none"> • ports: four • adjustable temperature limit stop: included • includes: volume control • check stops: included 		3570	232.40	1/2" CC	6

KINGSLEY®

HOW TO ORDER A COMPLETE SHOWERING FAUCET









NOTES

 Moen® **M•PACT®** Common Valve System

KINGSLEY® Moentrol® Showering

All Brushed Nickel faucet components feature the LifeShine® Non-Tarnish Finish.

		MODEL NUMBER	LIST PRICE	FINISH/ CONNECTION	CASE QTY
MOENTROL® VALVE TRIM					
 <ul style="list-style-type: none"> valve sold separately 		T3111	159.60	Chrome	3
		T3111BN	347.05	Brushed Nickel	3
		T3111ORB	347.05	Oil Rubbed Bronze	3
					
 <ul style="list-style-type: none"> ports: four adjustable temperature limit stop: included includes: volume control 		3510	210.05	1/2" IPS	6
		3520	210.05	1/2" CC	6
					
 <ul style="list-style-type: none"> ports: four adjustable temperature limit stop: included includes: volume control check stops: included 		3570	232.40	1/2" CC	6
					



HOW TO ORDER A COMPLETE VALVE











NOTES

 Moen® **M•PACT®** Common Valve System

KINGSLEY® Posi-Temp® Showering

All Brushed Nickel faucet components feature the LifeShine® Non-Tarnish Finish.

		MODEL NUMBER	LIST PRICE	FINISH/ CONNECTION	CASE QTY
POSI-TEMP® TUB/SHOWER					
	<ul style="list-style-type: none"> • showerhead functions: one-function • showerhead type: standard • showerhead size: 4-3/8" diameter spray head • showerhead flow rate: 2.5 gpm (9.5 L/min) max. • spout length: 5 1/2" • spout connection type: slip fit • tub spout type: diverter • valve sold separately 	T2113	266.35	Chrome	3
		T2113BN	441.70	Brushed Nickel	3
		T2113ORB	441.70	Oil Rubbed Bronze	3
		T2113WR	441.70	Wrought Iron	3
					
	<ul style="list-style-type: none"> • showerhead functions: one-function • showerhead type: eco-performance showerhead • showerhead size: 4-3/8" diameter spray head • showerhead flow rate: 1.75 gpm (6.65 L/min) max. • spout length: 5 1/2" • spout connection type: slip fit • tub spout type: diverter • valve sold separately 	T2113EP	266.35	Chrome	3
		T2113EPBN	441.70	Brushed Nickel	3
		T2113EPORB	441.70	Oil Rubbed Bronze	3
					
	<ul style="list-style-type: none"> • ports: four • adjustable temperature limit stop: included 	2510	152.20	1/2" IPS	6
		2520	152.20	1/2" CC	6
					
	<ul style="list-style-type: none"> • ports: four • adjustable temperature limit stop: included • quarter turn stops: included 	2570	194.75	1/2" CC	6
		2590	194.75	1/2" IPS	6
					

KINGSLEY®

HOW TO ORDER A COMPLETE TUB/SHOWER FAUCET











NOTES

 Moen® **M•PACT®** Common Valve System

KINGSLEY® Posi-Temp® Showering

All Brushed Nickel faucet components feature the LifeShine® Non-Tarnish Finish.

	MODEL NUMBER	LIST PRICE	FINISH/ CONNECTION	CASE QTY
POSI-TEMP® SHOWER ONLY				
 <ul style="list-style-type: none"> • showerhead functions: one-function • showerhead type: standard • showerhead size: 4-3/8" diameter spray head • showerhead flow rate: 2.5 gpm (9.5 L/min) max. • valve sold separately 	T2112	208.20	Chrome	3
	T2112BN	359.50	Brushed Nickel	3
	T2112ORB	359.50	Oil Rubbed Bronze	3
	T2112WR	359.50	Wrought Iron	3
 <ul style="list-style-type: none"> • showerhead functions: one-function • showerhead type: eco-performance showerhead • showerhead size: 4-3/8" diameter spray head • showerhead flow rate: 1.75 gpm (6.65 L/min) max. • valve sold separately 	T2112EP	208.20	Chrome	3
	T2112EPBN	359.50	Brushed Nickel	3
	T2112EPORB	359.50	Oil Rubbed Bronze	3
 <ul style="list-style-type: none"> • ports: four • adjustable temperature limit stop: included 	2510	152.20	1/2" IPS	6
	2520	152.20	1/2" CC	6
 <ul style="list-style-type: none"> • ports: four • adjustable temperature limit stop: included • quarter turn stops: included 	2570	194.75	1/2" CC	6
	2590	194.75	1/2" IPS	6



HOW TO ORDER A COMPLETE SHOWER FAUCET









NOTES

 Moen® **M•PACT®** Common Valve System

KINGSLEY® Posi-Temp® Showering, Bidets

All Brushed Nickel faucet components feature the LifeShine® Non-Tarnish Finish.

		MODEL NUMBER	LIST PRICE	FINISH/ CONNECTION	CASE QTY
POSI-TEMP® VALVE TRIM					
 <ul style="list-style-type: none"> • valve sold separately  		T2111	142.25	Chrome	3
		T2111BN	268.75	Brushed Nickel	3
		T2111ORB	268.75	Oil Rubbed Bronze	3
		T2111WR	268.75	Wrought Iron	3
 <ul style="list-style-type: none"> • ports: four • adjustable temperature limit stop: included 		2510	152.20	1/2" IPS	6
		2520	152.20	1/2" CC	6
 <ul style="list-style-type: none"> • ports: four • adjustable temperature limit stop: included • quarter turn stops: included 		2570	194.75	1/2" CC	6
		2590	194.75	1/2" IPS	6

KINGSLEY®

HOW TO ORDER A COMPLETE VALVE



HOW TO ORDER A COMPLETE BIDET FAUCET

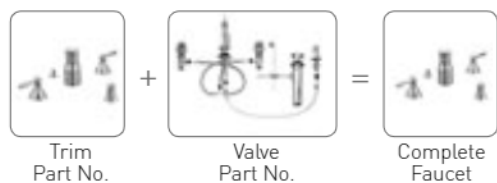

NOTES

-  Moen® **M•PACT®** Common Valve System
- DURALOCK** Duralock™ Quick Connections
- DURALAST** Duralast® Cartridge

KINGSLEY® Perfectly Matched Bath Accessories

Moen® makes it easy to coordinate the entire style and look of the bathroom. Our Kingsley® bath accessories perfectly match the style and finish of our Kingsley faucets. Total coordination of the bath has never been easier.



YB5401
Toilet Tank Lever



YB5403
Double Robe Hook



YB5405
Cabinet Knob
(Not available in WR)



YB5407
Drawer Pull
(Not available in WR)



YB5408 *Pivoting*
Pivoting Paper Holder



YB5418
18" Towel Bar



YB5422
24" Double Towel Bar



YB5424
24" Towel Bar



YB5486
Towel Ring



YB5494
Hotel Shelf
(Not available in WR)



YB5490
Glass Shelf

MODEL NUMBER	LIST PRICE EACH	DESCRIPTION	QTY
--------------	-----------------	-------------	-----

Chrome (CH)			
YB5401CH	49.00	Toilet Tank Lever	24
YB5403CH	43.65	Double Robe Hook	24
YB5405CH	9.25	Cabinet Knob	48
YB5407CH	18.60	Drawer Pull	48
<i>Pivoting</i> YB5408CH	82.65	Pivoting Paper Holder	6
YB5418CH	92.60	18" Towel Bar	6
YB5422CH	122.55	24" Double Towel Bar	6
YB5424CH	95.40	24" Towel Bar	6
YB5486CH	64.90	Towel Ring	6
YB5490CH	134.50	Glass Shelf [22.75"W x 5.25"D x 2.9"H]	3
YB5494CH	233.65	Hotel Shelf [26.8"W x 10"D x 6.4"H]	2

Brushed Nickel (BN)			
YB5401BN	56.25	Toilet Tank Lever	24
YB5403BN	49.50	Double Robe Hook	24
YB5405BN	11.70	Cabinet Knob	48
YB5407BN	22.70	Drawer Pull	48
<i>Pivoting</i> YB5408BN	91.10	Pivoting Paper Holder	6
YB5418BN	104.95	18" Towel Bar	6
YB5422BN	139.95	24" Double Towel Bar	6
YB5424BN	108.95	24" Towel Bar	6
YB5486BN	73.40	Towel Ring	6
YB5490BN	150.15	Glass Shelf [22.75"W x 5.25"D x 2.9"H]	3
YB5494BN	278.00	Hotel Shelf [26.8"W x 10"D x 6.4"H]	2

Oil Rubbed Bronze (ORB)			
YB5401ORB	56.25	Toilet Tank Lever	24
YB5403ORB	49.50	Double Robe Hook	24
YB5405ORB	12.20	Cabinet Knob	48
YB5407ORB	24.80	Drawer Pull	48
<i>Pivoting</i> YB5408ORB	91.10	Pivoting Paper Holder	6
YB5418ORB	104.95	18" Towel Bar	6
YB5422ORB	139.95	24" Double Towel Bar	6
YB5424ORB	108.95	24" Towel Bar	6
YB5486ORB	73.40	Towel Ring	6
YB5490ORB	150.15	Glass Shelf [22.75"W x 5.25"D x 2.9"H]	3
YB5494ORB	278.00	Hotel Shelf [26.8"W x 10"D x 6.4"H]	2

Wrought Iron (WR)			
YB5401WR	56.25	Toilet Tank Lever	24
YB5403WR	49.50	Double Robe Hook	24
<i>Pivoting</i> YB5408WR	91.10	Pivoting Paper Holder	6
YB5418WR	104.95	18" Towel Bar	6
YB5422WR	139.95	24" Double Towel Bar	6
YB5424WR	108.95	24" Towel Bar	6
YB5486WR	73.40	Towel Ring	6
YB5490WR	150.15	Glass Shelf [22.75"W x 5.25"D x 2.9"H]	3



KINGSLEY® Perfectly Matched Bath Accessories

GRAB BARS

PERFECTLY MATCHED to Moen® Kingsley® faucets and bath accessories. ADA-compliant.



SecureMount™ Grab Bars are manufactured with an innovative flange design that makes it easy to connect to the stud at multiple points.

To install grab bars securely without studs, use SecureMount™ Anchors. Sold separately.

MODEL NUMBER	LIST PRICE EACH	DESCRIPTION	QTY
1-1/4" • Chrome (CH)			
YG5412CH	128.65	12" Grab Bar	6
YG5418CH	144.55	18" Grab Bar	3
YG5424CH	159.35	24" Grab Bar	3
YG5430CH	174.65	30" Grab Bar	3
YG5436CH	189.95	36" Grab Bar	3
YG5442CH	205.25	42" Grab Bar	3
1-1/4" • Brushed Nickel (BN)			
YG5412BN	164.90	12" Grab Bar	6
YG5418BN	184.30	18" Grab Bar	3
YG5424BN	203.25	24" Grab Bar	3
YG5430BN	212.80	30" Grab Bar	3
YG5436BN	220.35	36" Grab Bar	3
YG5442BN	229.65	42" Grab Bar	3
1-1/4" • Oil Rubbed Bronze (ORB)			
YG5412ORB	164.90	12" Grab Bar	6
YG5418ORB	184.30	18" Grab Bar	3
YG5424ORB	203.25	24" Grab Bar	3
SecureMount Anchors™			
SMA1005CH	21.20	SecureMount Anchors™ (1 pc Chrome Mounting Plates)	3
SMA1000WB	48.80	SecureMount Anchors™ (2 pc Old World Bronze Mounting Plates)	24



YG5424
24" length
Grab Bar



KINGSLEY®













Complies with Americans with Disabilities Act (ADA) specifications.
SecureMount™ Grab Bars are tested to withstand 500 lb. pull when securely installed per instructions.

RIZON™ Bathroom Faucets

All Brushed Nickel faucet components feature the LifeShine® Non-Tarnish Finish.

	MODEL NUMBER	LIST PRICE	FINISH/ CONNECTION	CASE QTY
ONE-HANDLE BATHROOM FAUCET				
 <ul style="list-style-type: none"> • application: one or three hole • supply line length: flexible • connection size: 3/8" • connection type: compression • deck plate: sold separately • drain assembly: metal • drain assembly type: lift rod   DURALAST™	6900	281.20	Chrome	3
	6900BN	394.45	Brushed Nickel	3
	NEW! 6900BL*	394.45	Matte Black	-
	DECK PLATE SOLD SEPARATELY			
	165006	31.25	Chrome	20
	165006BN	51.20	Brushed Nickel	20
NEW! 165006BL*	51.20	Matte Black	1	

ONE-HANDLE BATHROOM VESSEL FAUCET				
 <ul style="list-style-type: none"> • application: one hole • supply line length: flexible • connection size: 3/8" • connection type: compression • drain assembly: 140780 sold separately  	6911	379.65	Chrome	3
	6911BN	532.40	Brushed Nickel	3
 <ul style="list-style-type: none"> • drain assembly: metal • drain assembly type: spring loaded pop-up 	140780	94.40	Chrome	12
	140780BN	136.05	Brushed Nickel	12

TWO-HANDLE WIDESPREAD BATHROOM FAUCET				
 <ul style="list-style-type: none"> • application: three hole • centre dimensions: 8" - 16" centre • drain assembly: metal • drain assembly type: lift rod • valve sold separately   	T6920	259.00	Chrome	3
	T6920BN	404.05	Brushed Nickel	3
	NEW! T6920BL*	404.05	Matte Black	-
 <ul style="list-style-type: none"> • application: three hole • centre dimensions: 8" - 16" centre • drain assembly: metal • drain assembly type: lift rod  DURALOCK™ DURALAST™	9000	148.70	1/2" IPS	6

HOW TO ORDER A COMPLETE BATHROOM FAUCET

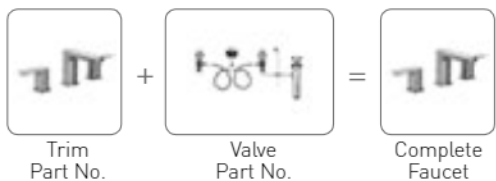









NOTES

-  Moen® **M•PACT®** Common Valve System
- DURALOCK™** Duralock™ Quick Connections
- DURALAST™** Duralast™ Cartridge
- *Ships Q2

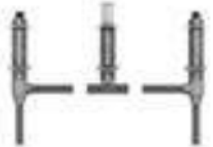
RIZON™

RIZON™ Roman Tub

All Brushed Nickel faucet components feature the LifeShine® Non-Tarnish Finish.

		MODEL NUMBER	LIST PRICE	FINISH/ CONNECTION	CASE QTY
TWO-HANDLE ROMAN TUB FAUCET					
 <ul style="list-style-type: none"> • application: three hole • spout reach: 7.68" • valve sold separately 		T935	312.80	Chrome	3
		T935BN	515.65	Brushed Nickel	3
		NEW! T935BL*	515.65	Matte Black	-
 <ul style="list-style-type: none"> • application: three hole • deck thickness: 1/8" to 3-3/8" rough deck • centre dimensions: adjustable • adjustable spout shank: included • test plug: included 		4792	188.00	1/2" CC	6
 <ul style="list-style-type: none"> • application: three hole • deck thickness: 1/8" to 1-7/8" deck • centre dimensions: 10" centre • non-adjustable spout shank: included • test plug: included 		4796 4798	179.95 179.95	1/2" CC 1/2" PEX, Cold Expansion PEX	6 6
 <ul style="list-style-type: none"> • description: high flow thermostatic mixing valve • 1/2" FNPT (3/8" compression adapters) • listed to ASSE Standard 1070 • max. flow rate at 45 psi = 10 gpm • tub application 		104465	223.55	1/2" FNPT	12
 <ul style="list-style-type: none"> • description: PEX transition fittings (2) and clips • adapts standard 1/2" PEX barb to 1/2" PEX cold expansion connections 		140715	11.35	1/2" PEX	200

RIZON™



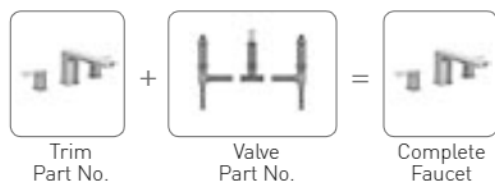



HOW TO ORDER A COMPLETE ROMAN TUB FAUCET







NOTES

 Moen® **M•PACT®** Common Valve System
*Ships Q2

All Brushed Nickel faucet components feature the LifeShine® Non-Tarnish Finish.

	MODEL NUMBER	LIST PRICE	FINISH/ CONNECTION	CASE QTY
TWO-HANDLE ROMAN TUB FAUCET WITH HANDSHOWER				
 <ul style="list-style-type: none"> • application: four hole • showerhead type: handshower • handshower functions: one-function • handshower flow rate: 1.75 gpm (6.65 L/min) max. • spout reach: 7.68" • valve sold separately  	T936	516.85	Chrome	3
	T936BN	769.30	Brushed Nickel	3
 <ul style="list-style-type: none"> • application: four hole • deck thickness: 1/8" to 2-5/8" deck • centre dimensions: 10" centre • non-adjustable spout shank: included • test plug: included 	9796	358.95	1/2" CC	6
	9797	358.95	1/2" CPVC, PEX	6
 <ul style="list-style-type: none"> • description: high flow thermostatic mixing valve • 1/2" FNPT (3/8" compression adapters) • listed to ASSE Standard 1070 • max. flow rate at 45 psi = 10 gpm • tub application 	104465	223.55	1/2" FNPT	12
 <ul style="list-style-type: none"> • description: PEX transition fittings (2) and clips • adapts standard 1/2" PEX barb to 1/2" PEX cold expansion connections 	140715	11.35	1/2" PEX	200



ONE-HANDLE ROMAN TUB WITH HANDSHOWER				
 <p>NEW!</p> <ul style="list-style-type: none"> • application: three hole • showerhead type: handshower • handshower functions: one-function • handshower flow rate: 1.75 gpm (6.65 L/min) max. • spout reach: 7.90" • red/blue markings included • valve sold separately  	T937	419.05	Chrome	3
	 <ul style="list-style-type: none"> • application: three hole • deck thickness: 1/8" to 2-5/8" rough deck • centre dimensions: 10" centre • test plug: included 	4791	282.65	1/2" CC
 <ul style="list-style-type: none"> • description: high flow thermostatic mixing valve • 1/2" FNPT (3/8" compression adapters) • listed to ASSE Standard 1070 • max. flow rate at 45 psi = 10 gpm • tub application 	104465	223.55	1/2" FNPT	12

HOW TO ORDER A COMPLETE ROMAN TUB FAUCET

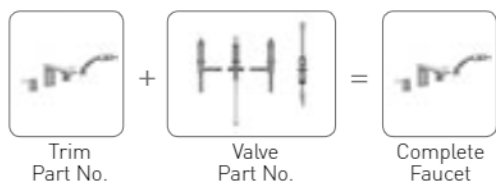













NOTES

 Moen® **M•PACT®** Common Valve System

RIZON™ Transfer Valve Shower Spa Components

All Brushed Nickel faucet components feature the LifeShine® Non-Tarnish Finish.

		MODEL NUMBER	LIST PRICE	FINISH/ CONNECTION	CASE QTY
3 INDEPENDENT FUNCTION TRANSFER VALVE ONLY					
 <ul style="list-style-type: none"> • use with 3362 transfer valve • valve: sold separately  		T2082	130.55	Chrome	12
		T2082BN	197.75	Brushed Nickel	12
		T2082BL*	197.75	Matte Black	-
		3362	215.60	1/2" CC	6
 <ul style="list-style-type: none"> • ports: four • type of function: three independent function • must be used with: Posi-Temp® or Moentrol® valve  					
2/3 FUNCTION TRANSFER VALVE ONLY					
 <ul style="list-style-type: none"> • use with 3372 or 3375 transfer valve • valve: sold separately  		T2081	125.25	Chrome	12
		T2081BN	189.70	Brushed Nickel	12
		T2081BL*	189.70	Matte Black	-
		3372	188.30	1/2" CC	12
 <ul style="list-style-type: none"> • type of function: two independent one shared • must be used with: Posi-Temp® or Moentrol® valve 					
		3375	188.30	1/2" CC	12
 <ul style="list-style-type: none"> • type of function: two independent functions • must be used with: Posi-Temp® or Moentrol® valve 					

HOW TO ORDER A COMPLETE TRANSFER VALVE











NOTES

-  Moen® **M•PACT**® Common Valve System
- DURALAST** Duralast® Cartridge
- *Ships Q2

RIZON™ Posi-Temp® Showering

All Brushed Nickel faucet components feature the LifeShine® Non-Tarnish Finish.

		MODEL NUMBER	LIST PRICE	FINISH/ CONNECTION	CASE QTY
POSI-TEMP® TUB/SHOWER					
	<ul style="list-style-type: none"> • showerhead functions: one-function • showerhead type: standard • showerhead size: 3-3/4" diameter spray head • showerhead flow rate: 2.5 gpm (9.5 L/min) max. • spout length: 7" • spout connection type: slip fit • tub spout type: diverter • red/blue markings: included • valve sold separately 	T2813	183.25	Chrome	3
		T2813BN	346.20	Brushed Nickel	3
		NEW! T2813BL*	346.20	Matte Black	3
					
	<ul style="list-style-type: none"> • showerhead functions: one-function • showerhead type: eco-performance showerhead • showerhead size: 3-3/4" diameter spray head • showerhead flow rate: 1.75 gpm (6.65 L/min) max. • spout length: 7" • spout connection type: slip fit • tub spout type: diverter • red/blue markings: included • valve sold separately 	T2813EP	183.25	Chrome	3
		T2813EPBN	346.20	Brushed Nickel	3
		NEW! T2813EPBL*	346.20	Matte Black	-
					
	<ul style="list-style-type: none"> • ports: four • adjustable temperature limit stop: included 	2510	152.20	1/2" IPS	6
		2520	152.20	1/2" CC	6
					
	<ul style="list-style-type: none"> • ports: four • adjustable temperature limit stop: included • quarter turn stops: included 	2570	194.75	1/2" CC	6
		2590	194.75	1/2" IPS	6
					

HOW TO ORDER A COMPLETE TUB/SHOWER FAUCET











NOTES

 Moen® **M•PACT®** Common Valve System
 *Ships Q2



RIZON™ Posi-Temp® Showering

All Brushed Nickel faucet components feature the LifeShine® Non-Tarnish Finish.

		MODEL NUMBER	LIST PRICE	FINISH/ CONNECTION	CASE QTY
POSI-TEMP® SHOWER ONLY					
	<ul style="list-style-type: none"> • showerhead functions: one-function • showerhead type: standard • showerhead size: 3-3/4" diameter spray head • showerhead flow rate: 2.5 gpm (9.5 L/min) max. • red/blue markings: included • valve sold separately 	T2812	127.10	Chrome	3
		T2812BN	263.55	Brushed Nickel	3
		T2812BL*	263.55	Matte Black	-
					
	<ul style="list-style-type: none"> • showerhead functions: one-function • showerhead type: eco-performance showerhead spray head • showerhead size: 3-3/4" diameter • showerhead flow rate: 1.75 gpm (6.65 L/min) max. • red/blue markings: included • valve sold separately 	T2812EP	127.10	Chrome	3
		T2812EPBN	263.55	Brushed Nickel	3
		T2812EPBL*	263.55	Matte Black	-
					
	<ul style="list-style-type: none"> • ports: four • adjustable temperature limit stop: included 	2510	152.20	1/2" IPS	6
		2520	152.20	1/2" CC	6
					
	<ul style="list-style-type: none"> • ports: four • adjustable temperature limit stop: included • quarter turn stops: included 	2570	194.75	1/2" CC	6
		2590	194.75	1/2" IPS	6
					

RIZON™

HOW TO ORDER A COMPLETE SHOWER FAUCET









NOTES

 Moen® **M•PACT®** Common Valve System

*Ships Q2

RIZON™ Posi-Temp® Showering

All Brushed Nickel faucet components feature the LifeShine® Non-Tarnish Finish.

		MODEL NUMBER	LIST PRICE	FINISH/ CONNECTION	CASE QTY
POSI-TEMP® VALVE TRIM					
 <ul style="list-style-type: none"> • red/blue markings: included • valve sold separately  		T2811	84.20	Chrome	3
		T2811BN	203.35	Brushed Nickel	3
		T2811BL*	203.35	Brushed Nickel	3
 <ul style="list-style-type: none"> • ports: four • adjustable temperature limit stop: included 		2510	152.20	1/2" IPS	6
		2520	152.20	1/2" CC	6
 <ul style="list-style-type: none"> • ports: four • adjustable temperature limit stop: included • quarter turn stops: included 		2570	194.75	1/2" CC	6
		2590	194.75	1/2" IPS	6



HOW TO ORDER A COMPLETE VALVE











NOTES

 Moen® **M•PACT®** Common Valve System
 *Ships Q2

DARTMOOR™ Bathroom Faucets

All Brushed Nickel faucet components feature the LifeShine® Non-Tarnish Finish.

	MODEL NUMBER	LIST PRICE	FINISH/ CONNECTION	CASE QTY
TWO-HANDLE BATHROOM FAUCET				
 <ul style="list-style-type: none"> • application: three hole • centre dimensions: 4" centre • connection size: 1/2" • connection type: IPS • drain assembly: metal • drain assembly type: lift rod   DURALAST™	6802	231.10	Chrome	3
	6802BN	330.90	Brushed Nickel	3
	6802ORB	330.90	Oil Rubbed Bronze	3
TWO-HANDLE WIDESPREAD BATHROOM FAUCET				
 <ul style="list-style-type: none"> • application: three hole • centre dimensions: 8" - 16" centre • drain assembly: metal • drain assembly type: lift rod • valve sold separately   	T6805	246.30	Chrome	3
	T6805BN	387.20	Brushed Nickel	3
	T6805ORB	387.20	Oil Rubbed Bronze	3
 <ul style="list-style-type: none"> • application: three hole • centre dimensions: 8" - 16" centre • drain assembly: metal • drain assembly type: lift rod  DURALOCK™ DURALAST™	9000	148.70	1/2" IPS	6

DARTMOOR™

HOW TO ORDER A COMPLETE BATHROOM FAUCET

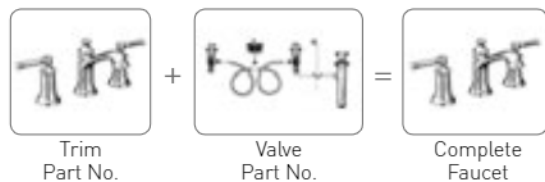









NOTES

-  Moen® **M•PACT**® Common Valve System
- DURALOCK™** Duralock® Quick Connections
- DURALAST™** Duralast® Cartridge

DARTMOOR™ Roman Tubs

All Brushed Nickel faucet components feature the LifeShine® Non-Tarnish Finish.

	MODEL NUMBER	LIST PRICE	FINISH/ CONNECTION	CASE QTY
TWO-HANDLE ROMAN TUB FAUCET				
 <ul style="list-style-type: none"> • application: three hole • spout reach: 7.64" • valve sold separately 	T683	344.05	Chrome	3
	T683BN	567.15	Brushed Nickel	3
	T683ORB	567.15	Oil Rubbed Bronze	3
 <ul style="list-style-type: none"> • application: three hole • deck thickness: 1/8" to 3-3/8" rough deck • centre dimensions: adjustable • adjustable spout shank: included • test plug: included 	4792	188.00	1/2" CC	6
	 <ul style="list-style-type: none"> • application: three hole • deck thickness: 1/8" to 1-7/8" rough deck • centre dimensions: 10" centre • non-adjustable spout shank: included • test plug: included 	4796	179.95	1/2" CC
		4798	179.95	1/2" Crimp ring PEX, Cold Expansion PEX
 <ul style="list-style-type: none"> • description: high flow thermostatic mixing valve for roman tubs • ports: three • ASSE standard 1070: yes • flow rate: 12.0 gpm (45.4 L/min) max. 	104465	223.55	1/2" CC	12
 <ul style="list-style-type: none"> • description: PEX transition fittings (2) and clips • connections: adapts standard 1/2" PEX barb to 1/2" PEX cold expansion 	140715	11.35	1/2" PEX	200



HOW TO ORDER A COMPLETE ROMAN TUB FAUCET

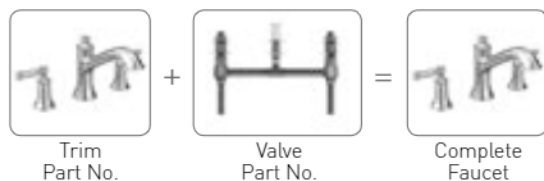











NOTES

 Moen® M•PACT® Common Valve System

DARTMOOR™ Posi-Temp® Showering

All Brushed Nickel faucet components feature the LifeShine® Non-Tarnish Finish.

DARTMOOR™

		MODEL NUMBER	LIST PRICE	FINISH/ CONNECTION	CASE QTY
POSI-TEMP® TUB/SHOWER					
	<ul style="list-style-type: none"> • showerhead functions: one-function • showerhead type: standard • showerhead size: 4" diameter spray head • showerhead flow rate: 2.5 gpm (9.5 L/min) max. • spout length: 7" • spout connection type: slip fit • tub spout type: diverter • valve sold separately 	T2183	148.90	Chrome	3
		T2183BN	317.00	Brushed Nickel	3
		T2183ORB	317.00	Oil Rubbed Bronze	3
					
	<ul style="list-style-type: none"> • showerhead functions: one-function • showerhead type: eco-performance showerhead • showerhead size: 4" diameter spray head • showerhead flow rate: 1.75 gpm (6.65 L/min) max. • spout length: 7" • spout connection type: slip fit • tub spout type: diverter • valve sold separately 	T2183EP	148.90	Chrome	3
		T2183EPBN	317.00	Brushed Nickel	3
		T2183EPORB	317.00	Oil Rubbed Bronze	3
					
	<ul style="list-style-type: none"> • showerhead functions: one-function • showerhead type: eco-performance rainshower • showerhead size: 8" diameter spray head • showerhead flow rate: 2.0 gpm (7.6 L/min) max. • spout length: 7" • spout connection type: slip fit • tub spout type: diverter • valve sold separately 	T2283EP	218.15	Chrome	4
		T2283EPBN	413.85	Brushed Nickel	4
		T2283EPORB	413.85	Oil Rubbed Bronze	4
					
	<ul style="list-style-type: none"> • ports: four • adjustable temp limit stop: included 	2510	152.20	1/2" IPS	6
		2520	152.20	1/2" CC	6
					
	<ul style="list-style-type: none"> • ports: four • adjustable temp limit stop: included • quarter turn stops: included 	2570	194.75	1/2" CC	6
		2590	194.75	1/2" IPS	6
					

HOW TO ORDER A COMPLETE TUB/SHOWER FAUCET

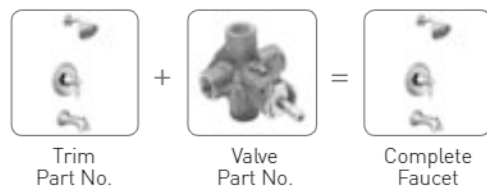











NOTES

 Moen® **M•PACT®** Common Valve System

DARTMOOR™ Posi-Temp® Showering

All Brushed Nickel faucet components feature the LifeShine® Non-Tarnish Finish.

		MODEL NUMBER	LIST PRICE	FINISH/ CONNECTION	CASE QTY
POSI-TEMP® SHOWER ONLY					
	<ul style="list-style-type: none"> • showerhead functions: one-function • showerhead type: standard • showerhead size: 4" diameter spray head • showerhead flow rate: 2.5 gpm (9.5 L/min) max. • valve sold separately 	T2182	103.15	Chrome	3
		T2182BN	241.00	Brushed Nickel	3
		T2182ORB	241.00	Oil Rubbed Bronze	3
					
	<ul style="list-style-type: none"> • showerhead functions: one-function • showerhead type: eco-performance showerhead • showerhead size: 4" diameter spray head • showerhead flow rate: 1.75 gpm (6.65 L/min) max. • valve sold separately 	T2182EP	103.15	Chrome	3
		T2182EPBN	241.00	Brushed Nickel	3
		T2182EPORB	241.00	Oil Rubbed Bronze	3
					
	<ul style="list-style-type: none"> • showerhead functions: one-function • showerhead type: eco-performance rainshower • showerhead size: 8" diameter spray head • showerhead flow rate: 2.0 gpm (7.6 L/min) max. • valve sold separately 	T2282EP	172.50	Chrome	4
		T2282EPBN	337.85	Brushed Nickel	4
		T2282EPORB	337.85	Oil Rubbed Bronze	4
					
	<ul style="list-style-type: none"> • ports: four • adjustable temp limit stop: included 	2510	152.20	1/2" IPS	6
		2520	152.20	1/2" CC	6
					
	<ul style="list-style-type: none"> • ports: four • adjustable temp limit stop: included • quarter turn stops: included 	2570	194.75	1/2" CC	6
		2590	194.75	1/2" IPS	6
					



HOW TO ORDER A COMPLETE SHOWER FAUCET

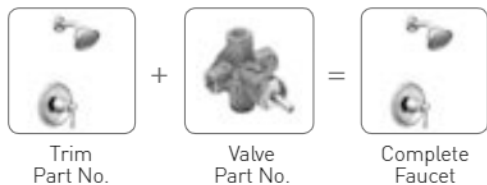







NOTES

 Moen® **M•PACT®** Common Valve System

DARTMOOR™ Posi-Temp® Showering

All Brushed Nickel faucet components feature the LifeShine® Non-Tarnish Finish.

		MODEL NUMBER	LIST PRICE	FINISH/ CONNECTION	CASE QTY
POSI-TEMP® VALVE TRIM					
 <ul style="list-style-type: none"> • valve sold separately  		T2181	80.95	Chrome	3
		T2181BN	196.15	Brushed Nickel	3
		T2181ORB	196.15	Oil Rubbed Bronze	3
 <ul style="list-style-type: none"> • ports: four • adjustable temp limit stop: included 		2510	152.20	1/2" IPS	6
		2520	152.20	1/2" CC	6
 <ul style="list-style-type: none"> • ports: four • adjustable temp limit stop: included • quarter turn stops: included 		2570	194.75	1/2" CC	6
		2590	194.75	1/2" IPS	6

DARTMOOR™

HOW TO ORDER A COMPLETE VALVE



NOTES

 Moen® **M•PACT®** Common Valve System



See page 54 for details.

DARTMOOR™ Perfectly Matched Bath Accessories

Moen makes it easy to coordinate the entire style and look of the bathroom. Our Dartmoor™ bath accessories perfectly match the style and finish of our Dartmoor faucets. Total coordination of the bath has never been easier.

MODEL NUMBER	LIST PRICE EACH	DESCRIPTION	QTY
Chrome (CH)			
YB2101CH	29.90	Toilet Tank Lever	6
YB2103CH	26.45	Double Robe Hook	24
YB2108CH	44.05	Paper Holder	6
YB2118CH	52.85	18" Towel Bar	6
YB2124CH	58.75	24" Towel Bar	6
YB2186CH	35.25	Towel Ring	6
Brushed Nickel (BN)			
YB2101BN	47.95	Toilet Tank Lever	6
YB2103BN	35.80	Double Robe Hook	24
YB2108BN	64.40	Paper Holder	6
YB2118BN	79.05	18" Towel Bar	6
YB2124BN	83.15	24" Towel Bar	6
YB2186BN	49.00	Towel Ring	6
Oil Rubbed Bronze (ORB)			
YB2101ORB	47.95	Toilet Tank Lever	6
YB2103ORB	35.80	Double Robe Hook	24
YB2108ORB	64.40	Paper Holder	6
YB2118ORB	79.05	18" Towel Bar	6
YB2124ORB	83.15	24" Towel Bar	6
YB2186ORB	49.00	Towel Ring	6
Miscellaneous			
YB8081	16.30	Pro-Fit® Installation Mounting Template	25



YB2101 Toilet Tank Lever



YB2103 Double Robe Hook



YB2108 Paper Holder



YB2118 18" Towel Bar



YB2124 24" Towel Bar



YB2186 Towel Ring











YB8081 Pro-Fit® Installation Mounting Template (See page 54 for more information about the Pro-Fit® Installation System).



GLYDE™ Bathroom Faucets

All Brushed Nickel faucet components feature the LifeShine® Non-Tarnish Finish.

	MODEL NUMBER	LIST PRICE	FINISH/ CONNECTION	CASE QTY
TWO-HANDLE BATHROOM FAUCET				
 <ul style="list-style-type: none"> • application: three hole • centre dimensions: 4" centre • connection size: 1/2" • connection type: IPS • drain assembly : metal • drain assembly type: lift rod   DURALAST™	6172	231.10	Chrome	3
	6172BN	330.90	Brushed Nickel	3
TWO-HANDLE WIDESPREAD BATHROOM FAUCET				
 <ul style="list-style-type: none"> • application: three hole • centre dimensions: 8" - 16" centre • drain assembly : metal • drain assembly type: lift rod • valve sold separately  	T6173	246.30	Chrome	3
	T6173BN	387.20	Brushed Nickel	3
 <ul style="list-style-type: none"> • application: three hole • centre dimensions: 8" - 16" centre • drain assembly : metal • drain assembly type: lift rod  DURALOCK® DURALAST™	9000	148.70	1/2" IPS	6

HOW TO ORDER A COMPLETE BATHROOM FAUCET

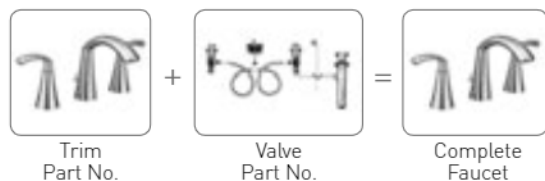









NOTES

-  Moen® **M•PACT®** Common Valve System
- DURALOCK®** Duralock® Quick Connections
- DURALAST™** Duralast® Cartridge

GLYDE™ Roman Tub

All Brushed Nickel faucet components feature the LifeShine® Non-Tarnish Finish.

	MODEL NUMBER	LIST PRICE	FINISH/ CONNECTION	CASE QTY
TWO-HANDLE ROMAN TUB				
 <ul style="list-style-type: none"> • application: three hole • spout reach: 7.65" • valve sold separately 	T373 T373BN	344.05 567.15	Chrome Brushed Nickel	3 3
 <ul style="list-style-type: none"> • application: three hole • deck thickness: 1/8" to 3-3/8" rough deck • centre dimensions: adjustable • adjustable spout shank: included • test plug: included 	4792	188.00	1/2" CC	6
 <ul style="list-style-type: none"> • application: three hole • deck thickness: 1/8" to 1-7/8" rough deck • centre dimensions: 10" centre • non-adjustable spout shank: included • test plug: included 	4796 4798	179.95 179.95	1/2" CC 1/2" Crimp ring PEX, Cold Expansion PEX	6 6
 <ul style="list-style-type: none"> • description: high flow thermostatic mixing valve for roman tubs • ports: three • ASSE standard 1070: yes • flow rate: 12.0 gpm (45.4 L/min) max. 	104465	223.55	1/2" CC	12
 <ul style="list-style-type: none"> • description: PEX transition fittings (2) and clips • connections: adapts standard 1/2" PEX barb to 1/2" PEX cold expansion 	140715	11.35	1/2" PEX	200



HOW TO ORDER A COMPLETE ROMAN TUB FAUCET

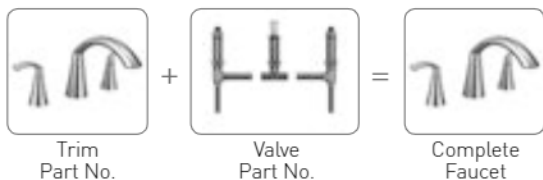











NOTES

 Moen® M•PACT® Common Valve System

GLYDE™ Posi-Temp® Showering

All Brushed Nickel faucet components feature the LifeShine® Non-Tarnish Finish.

		MODEL NUMBER	LIST PRICE	FINISH/ CONNECTION	CASE QTY
POSI-TEMP® TUB/SHOWER					
	<ul style="list-style-type: none"> • showerhead functions: one-function • showerhead type: standard • showerhead size: 3-7/8" diameter spray head • showerhead flow rate: 2.5 gpm (9.5 L/min) max. • spout length: 7" • spout connection type: slip fit • tub spout type: diverter • valve sold separately 	T2743	148.90	Chrome	3
		T2743BN	317.00	Brushed Nickel	3
					
	<ul style="list-style-type: none"> • showerhead functions: one-function • showerhead type: eco-performance showerhead • showerhead size: 3-7/8" diameter spray head • showerhead flow rate: 1.75 gpm (6.65 L/min) max. • spout length: 7" • spout connection type: slip fit • tub spout type: diverter • valve sold separately 	T2743EP	148.90	Chrome	3
		T2743EPBN	317.00	Brushed Nickel	3
					
	<ul style="list-style-type: none"> • showerhead functions: one-function • showerhead type: eco-performance rainshower • showerhead size: 8" diameter spray head • showerhead flow rate: 2.0 gpm (7.6 L/min) max. • spout length: 7" • spout connection type: slip fit • tub spout type: diverter • valve sold separately 	T2843EP	218.15	Chrome	4
		T2843EPBN	413.85	Brushed Nickel	4
					
	<ul style="list-style-type: none"> • ports: four • adjustable temp limit stop: included 	2510	152.20	1/2" IPS	6
		2520	152.20	1/2" CC	6
					
	<ul style="list-style-type: none"> • ports: four • adjustable temp limit stop: included • quarter turn stops: included 	2570	194.75	1/2" CC	6
		2590	194.75	1/2" IPS	6
					

HOW TO ORDER A COMPLETE TUB/SHOWER FAUCET

















NOTES

 Moen® M•PACT® Common Valve System

GLYDE™ Posi-Temp® Showering

All Brushed Nickel faucet components feature the LifeShine® Non-Tarnish Finish.

		MODEL NUMBER	LIST PRICE	FINISH/ CONNECTION	CASE QTY
POSI-TEMP® SHOWER ONLY					
	<ul style="list-style-type: none"> • showerhead functions: one-function • showerhead type: standard • showerhead size: 3-7/8" diameter spray head • showerhead flow rate: 2.5 gpm (9.5 L/min) max. • valve sold separately 	T2742	103.15	Chrome	3
		T2742BN	241.00	Brushed Nickel	3
 					
	<ul style="list-style-type: none"> • showerhead functions: one-function • showerhead type: eco-performance showerhead • showerhead size: 3-7/8" diameter spray head • showerhead flow rate: 1.75 gpm (6.65 L/min) max. • valve sold separately 	T2742EP	103.15	Chrome	3
		T2742EPBN	241.00	Brushed Nickel	3
  					
	<ul style="list-style-type: none"> • showerhead functions: one-function • showerhead type: eco-performance rainshower • showerhead size: 8" diameter spray head • showerhead flow rate: 2.0 gpm (7.6 L/min) max. • valve sold separately 	T2842EP	172.50	Chrome	4
		T2842EPBN	337.85	Brushed Nickel	4
  					
	<ul style="list-style-type: none"> • ports: four • adjustable temp limit stop: included 	2510	152.20	1/2" IPS	6
		2520	152.20	1/2" CC	6
					
	<ul style="list-style-type: none"> • ports: four • adjustable temp limit stop: included • quarter turn stops: included 	2570	194.75	1/2" CC	6
		2590	194.75	1/2" IPS	6
					



HOW TO ORDER A COMPLETE SHOWER FAUCET

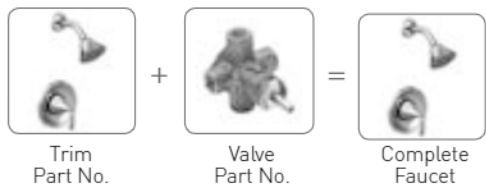







NOTES

Moën® M•PACT® Common Valve System

GLYDE™ Posi-Temp® Showering

All Brushed Nickel faucet components feature the LifeShine® Non-Tarnish Finish.

		MODEL NUMBER	LIST PRICE	FINISH/ CONNECTION	CASE QTY
POSI-TEMP® VALVE TRIM					
 <ul style="list-style-type: none"> • valve sold separately  		T2741	80.95	Chrome	3
		T2741BN	196.15	Brushed Nickel	3
 <ul style="list-style-type: none"> • ports: four • adjustable temp limit stop: included 		2510	152.20	1/2" IPS	6
		2520	152.20	1/2" CC	6
 <ul style="list-style-type: none"> • ports: four • adjustable temp limit stop: included • quarter turn stops: included 		2570	194.75	1/2" CC	6
		2590	194.75	1/2" IPS	6

GLYDE™

HOW TO ORDER A COMPLETE VALVE



NOTES

 Moen® **M•PACT®** Common Valve System



See page 54 for details.

GLYDE™ Perfectly Matched Bath Accessories

Moен makes it easy to coordinate the entire style and look of the bathroom. Our Glyde™ bath accessories perfectly match the style and finish of our Glyde faucets. Total coordination of the bath has never been easier.

MODEL NUMBER	LIST PRICE EACH	DESCRIPTION	QTY
Chrome (CH)			
YB2303CH	26.45	Double Robe Hook	24
YB2308CH	44.05	Paper Holder	6
YB2318CH	52.85	18" Towel Bar	3
YB2324CH	58.75	24" Towel Bar	6
YB2386CH	35.25	Towel Ring	6
Brushed Nickel (BN)			
YB2303BN	35.80	Double Robe Hook	24
YB2308BN	64.40	Paper Holder	6
YB2318BN	79.05	18" Towel Bar	3
YB2324BN	83.15	24" Towel Bar	6
YB2386BN	49.00	Towel Ring	6
Miscellaneous			
YB8081	16.30	Pro-Fit® Installation Mounting Template	25



YB2303
Double Robe Hook



YB2308
Paper Holder



YB2386
Towel Ring



YB2318
18" Towel Bar



YB2324
24" Towel Bar















YB8081
Pro-Fit® Installation Mounting Template [See page 54 for more information about the Pro-Fit® Installation System].



BRANTFORD™ Bathroom Faucets

All Brushed Nickel faucet components feature the LifeShine® Non-Tarnish Finish.

		MODEL NUMBER	LIST PRICE	FINISH/ CONNECTION	CASE QTY
ONE-HANDLE BATHROOM FAUCET					
 <ul style="list-style-type: none"> • application: one or three hole • supply line length: flexible • connection size: 3/8" • connection type: compression • deck plate: included • drain assembly: metal • drain assembly type: lift rod   DURALAST™		6600	281.20	Chrome	3
		6600BN	394.45	Brushed Nickel	3
		6600ORB	394.45	Oil Rubbed Bronze	3
 <ul style="list-style-type: none"> • description: vessel extension kit • includes: two 2.5" extensions • includes: parts to convert to grid drain 		A1717	138.45	Chrome	6
		A1717BN	224.65	Brushed Nickel	6
		A1717ORB	224.65	Oil Rubbed Bronze	6
TWO-HANDLE BATHROOM FAUCET					
 <ul style="list-style-type: none"> • application: three hole • centre dimensions: 4" centre • connection size: 1/2" • connection type: IPS • drain assembly: metal • drain assembly type: lift rod  		6610	210.15	Chrome	6
		6610BN	300.80	Brushed Nickel	6
		6610ORB	300.80	Oil Rubbed Bronze	6
TWO-HANDLE WIDESPREAD BATHROOM FAUCET					
 <ul style="list-style-type: none"> • application: three hole • centre dimensions: 8" - 16" centre • drain assembly: metal • drain assembly type: lift rod • valve sold separately   		T6620	223.90	Chrome	3
		T6620BN	352.00	Brushed Nickel	3
		T6620ORB	352.00	Oil Rubbed Bronze	3
 <ul style="list-style-type: none"> • application: three hole • centre dimensions: 8" - 16" centre • drain assembly: metal • drain assembly type: lift rod  DURALOCK® DURALAST™		9000	148.70	1/2" IPS	6

HOW TO ORDER A COMPLETE BATHROOM FAUCET

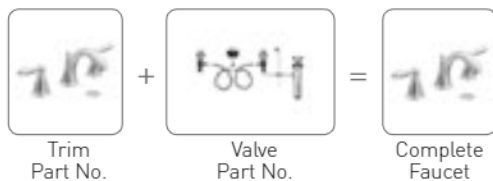







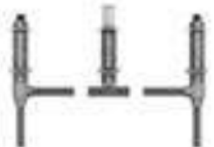

NOTES

-  Moen® **M•PACT®** Common Valve System
- DURALOCK®** Duralock™ Quick Connections
- DURALAST™** Duralast® Cartridge

BRANTFORD™ Garden Tubs

All Brushed Nickel faucet components feature the LifeShine® Non-Tarnish Finish.

	MODEL NUMBER	LIST PRICE	FINISH/ CONNECTION	CASE QTY
TWO-HANDLE GARDEN TUB				
 <ul style="list-style-type: none"> • application: three hole • spout reach: 6.50" • valve sold separately 	T4943 T4943BN T4943ORB	215.80 403.15 403.15	Chrome Brushed Nickel Oil Rubbed Bronze	3 3 3
 <ul style="list-style-type: none"> • application: three hole • deck thickness: 1/8" to 3-3/8" rough deck • centre dimensions: adjustable • adjustable spout shank: included • test plug: included 	4792	188.00	1/2" CC	6
 <ul style="list-style-type: none"> • application: three hole • deck thickness: 1/8" to 1-7/8" deck • centre dimensions: 10" centre • non-adjustable spout shank: included • test plug: included 	4796 4798	179.95 179.95	1/2" CC 1/2" PEX, Cold Expansion PEX	6 6
 <ul style="list-style-type: none"> • description: high flow thermostatic mixing valve • 1/2" FNPT (3/8" compression adapters) • listed to ASSE Standard 1070 • max. flow rate at 45 psi = 10 gpm • tub application 	104465	223.55	1/2" FNPT	12
 <ul style="list-style-type: none"> • description: PEX transition fittings (2) and clips • adapts standard 1/2" PEX barb to 1/2" PEX cold expansion connections 	140715	11.35	1/2" PEX	200

BRANTFORD™

HOW TO ORDER A COMPLETE GARDEN TUB FAUCET

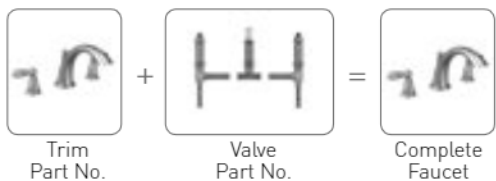







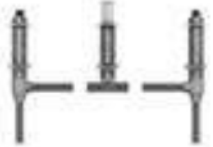

NOTES

 Moen® **M•PACT®** Common Valve System

BRANTFORD™ Roman Tubs

All Brushed Nickel faucet components feature the LifeShine® Non-Tarnish Finish.

	MODEL NUMBER	LIST PRICE	FINISH/ CONNECTION	CASE QTY
TWO-HANDLE ROMAN TUB				
 <ul style="list-style-type: none"> • application: three hole • spout reach: 8.13" • valve sold separately 	T933 T933BN T933ORB	312.80 515.65 515.65	Chrome Brushed Nickel Oil Rubbed Bronze	3 3 3
 <ul style="list-style-type: none"> • application: three hole • deck thickness: 1/8" to 3-3/8" rough deck • centre dimensions: adjustable • adjustable spout shank: included • test plug: included 	4792	188.00	1/2" CC	6
 <ul style="list-style-type: none"> • application: three hole • deck thickness: 1/8" to 1-7/8" deck • centre dimensions: 10" centre • non-adjustable spout shank: included • test plug: included 	4796 4798	179.95 179.95	1/2" CC 1/2" PEX, Cold Expansion PEX	6 6
 <ul style="list-style-type: none"> • description: high flow thermostatic mixing valve • 1/2" FNPT (3/8" compression adapters) • listed to ASSE Standard 1070 • max. flow rate at 45 psi = 10 gpm • tub application 	104465	223.55	1/2" FNPT	12
 <ul style="list-style-type: none"> • description: PEX transition fittings (2) and clips • adapts standard 1/2" PEX barb to 1/2" PEX cold expansion connections 	140715	11.35	1/2" PEX	200

BRANTFORD™

HOW TO ORDER A COMPLETE ROMAN TUB FAUCET

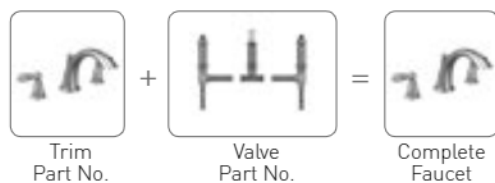







NOTES

 Moen® **M•PACT**® Common Valve System

BRANTFORD™ Roman Tubs

All Brushed Nickel faucet components feature the LifeShine® Non-Tarnish Finish.

	MODEL NUMBER	LIST PRICE	FINISH/ CONNECTION	CASE QTY
TWO-HANDLE ROMAN TUB WITH HANDSHOWER				
 <ul style="list-style-type: none"> • application: four hole • showerhead type: handshower • handshower functions: one-function • handshower flow rate: 1.75 gpm [6.65 L/min] max. • spout reach: 8.13" • valve sold separately 	T924	516.85	Chrome	3
	T924BN	769.30	Brushed Nickel	3
	T924ORB	769.30	Oil Rubbed Bronze	3
 <ul style="list-style-type: none"> • application: four hole • deck thickness: 1/8" to 2-5/8" deck • centre dimensions: 10" centre • non-adjustable spout shank: included • test plug: included 	9796	358.95	1/2" CC	6
	9797	358.95	1/2" CPVC, PEX	6
 <ul style="list-style-type: none"> • description: high flow thermostatic mixing valve • 1/2" FNPT (3/8" compression adapters) • listed to ASSE Standard 1070 • max. flow rate at 45 psi = 10 gpm • tub application 	104465	223.55	1/2" FNPT	12
 <ul style="list-style-type: none"> • description: PEX transition fittings (2) and clips • adapts standard 1/2" PEX barb to 1/2" PEX cold expansion connections 	140715	11.35	1/2" PEX	200

BRANTFORD™

HOW TO ORDER A COMPLETE ROMAN TUB FAUCET

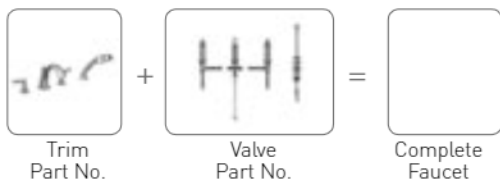







NOTES

 Moen® **M•PACT®** Common Valve System

BRANTFORD™ Posi-Temp® Showering/Transfer Valve Trim

All Brushed Nickel faucet components feature the LifeShine® Non-Tarnish Finish.

		MODEL NUMBER	LIST PRICE	FINISH/ CONNECTION	CASE QTY
2/3 FUNCTION TRANSFER VALVE ONLY					
 <ul style="list-style-type: none"> • use with 3372 or 3375 transfer valve • valve: sold separately  		T2021	122.55	Chrome	12
		T2021BN	185.65	Brushed Nickel	12
		T2021ORB	185.65	Oil Rubbed Bronze	12
 <ul style="list-style-type: none"> • type of function: two independent one shared • must be used with: Posi-Temp® or Moentrol® valve 		3372	188.30	1/2" CC	12
 <ul style="list-style-type: none"> • type of function: two independent functions • must be used with: Posi-Temp® or Moentrol® valve 		3375	188.30	1/2" CC	12

BRANTFORD™

HOW TO ORDER A COMPLETE TRANSFER VALVE













NOTES

 Moen® M•PACT® Common Valve System

BRANTFORD™ Posi-Temp® Showering

All Brushed Nickel faucet components feature the LifeShine® Non-Tarnish Finish.

		MODEL NUMBER	LIST PRICE	FINISH/ CONNECTION	CASE QTY
POSI-TEMP® TUB/SHOWER					
	<ul style="list-style-type: none"> • showerhead functions: one-function • showerhead type: standard • showerhead size: 3-3/8" diameter spray head • showerhead flow rate: 2.5 gpm (9.5 L/min) max. • spout length: 6 1/2" • spout connection type: slip fit • tub spout type: diverter • valve sold separately 	T2153	135.30	Chrome	3
		T2153BN	288.15	Brushed Nickel	3
		T2153ORB	288.15	Oil Rubbed Bronze	3
					
	<ul style="list-style-type: none"> • showerhead functions: one-function • showerhead type: eco-performance showerhead • showerhead size: 3-3/8" diameter spray head • showerhead flow rate: 1.75 gpm (6.65 L/min) max. • spout length: 6 1/2" • spout connection type: slip fit • tub spout type: diverter • valve sold separately 	T62153EP	135.30	Chrome	12
		T2153EPBN	288.15	Brushed Nickel	3
		T2153EPORB	288.15	Oil Rubbed Bronze	3
					
	<ul style="list-style-type: none"> • showerhead functions: one-function • showerhead type: eco-performance rainshower • showerhead size: 8" diameter spray head • showerhead flow rate: 1.75 gpm (6.65 L/min) max. • spout length: 6 1/2" • spout connection type: slip fit • tub spout type: diverter • valve sold separately 	T2253EP	204.60	Chrome	4
		T2253EPBN	385.05	Brushed Nickel	4
		T2253EPORB	385.05	Oil Rubbed Bronze	4
					
	<ul style="list-style-type: none"> • ports: four • adjustable temperature limit stop: included 	2510	152.20	1/2" IPS	6
		2520	152.20	1/2" CC	6
					
	<ul style="list-style-type: none"> • ports: four • adjustable temperature limit stop: included • quarter turn stops: included 	2570	194.75	1/2" CC	6
		2590	194.75	1/2" IPS	6
					

BRANTFORD™

HOW TO ORDER A COMPLETE TUB/SHOWER FAUCET













NOTES

 Moen® M•FACT® Common Valve System

BRANTFORD™ Posi-Temp® Showering

All Brushed Nickel faucet components feature the LifeShine® Non-Tarnish Finish.

		MODEL NUMBER	LIST PRICE	FINISH/ CONNECTION	CASE QTY
POSI-TEMP® SHOWER ONLY					
	<ul style="list-style-type: none"> • showerhead functions: one-function • showerhead type: standard • showerhead size: 3-3/8" diameter spray head • showerhead flow rate: 2.5 gpm (9.5 L/min) max. • valve sold separately 	T2152	93.80	Chrome	3
		T2152BN	219.10	Brushed Nickel	3
		T2152ORB	219.10	Oil Rubbed Bronze	3
					
	<ul style="list-style-type: none"> • showerhead functions: one-function • showerhead type: eco-performance showerhead • showerhead size: 3-3/8" diameter spray head • showerhead flow rate: 1.75 gpm (6.65 L/min) max. • valve sold separately 	T62152EP	93.80	Chrome	12
		T2152EPBN	219.10	Brushed Nickel	3
		T2152EPORB	219.10	Oil Rubbed Bronze	3
					
	<ul style="list-style-type: none"> • showerhead functions: one-function • showerhead type: eco-performance rainshower • showerhead size: 8" diameter spray head • showerhead flow rate: 1.75 gpm (6.65 L/min) max. • valve sold separately 	T2252EP	163.05	Chrome	4
		T2252EPBN	315.95	Brushed Nickel	4
		T2252EPORB	315.95	Oil Rubbed Bronze	4
					
	<ul style="list-style-type: none"> • ports: four • adjustable temperature limit stop: included 	2510	152.20	1/2" IPS	6
		2520	152.20	1/2" CC	6
					
	<ul style="list-style-type: none"> • ports: four • adjustable temperature limit stop: included • quarter turn stops: included 	2570	194.75	1/2" CC	6
		2590	194.75	1/2" IPS	6
					

BRANTFORD™

HOW TO ORDER A COMPLETE SHOWER FAUCET















NOTES

 Moen® **M•FACT®** Common Valve System

BRANTFORD™ Posi-Temp® Showering, Bidets

All Brushed Nickel faucet components feature the LifeShine® Non-Tarnish Finish.

	MODEL NUMBER	LIST PRICE	FINISH/ CONNECTION	CASE QTY
POSI-TEMP® VALVE TRIM				
 <ul style="list-style-type: none"> valve sold separately  	T2151	73.65	Chrome	3
	T2151BN	178.35	Brushed Nickel	3
	T2151ORB	178.35	Oil Rubbed Bronze	3
 <ul style="list-style-type: none"> ports: four adjustable temperature limit stop: included 	2510	152.20	1/2" IPS	6
	2520	152.20	1/2" CC	6
 <ul style="list-style-type: none"> ports: four adjustable temperature limit stop: included quarter turn stops: included 	2570	194.75	1/2" CC	6
	2590	194.75	1/2" IPS	6

TWO-HANDLE BIDET				
 <ul style="list-style-type: none"> valve sold separately  	T5225	429.05	Chrome	3
	T5225BN	626.10	Brushed Nickel	3
	T5225ORB	626.10	Oil Rubbed Bronze	3
 <ul style="list-style-type: none"> application: three hole centre dimensions: 8" - 16" centre  DURALOCK® DURALAST®	9265	319.85	1/2" IPS	6

HOW TO ORDER A COMPLETE VALVE



HOW TO ORDER A COMPLETE BIDET FAUCET

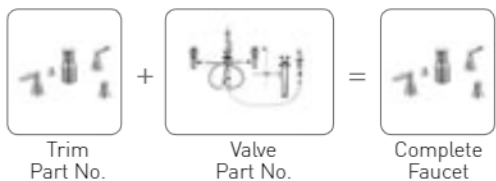

NOTES

-  Moen® **M•PACT®** Common Valve System
- DURALOCK®** Duralock™ Quick Connections
- DURALAST®** Duralast® Cartridge

BRANTFORD™

BRANTFORD™ Perfectly Matched Bath Accessories



See page 54 for details.

Moen® makes it easy to coordinate the entire style and look of the bathroom. Our Brantford™ bath accessories perfectly match the style and finish of our Brantford faucets. Total coordination of the bath has never been easier.

MODEL NUMBER	LIST PRICE EACH	DESCRIPTION	QTY
Chrome (CH)			
YB2201CH	27.40	Toilet Tank Lever	6
YB2203CH	19.55	Double Robe Hook	24
YB2208CH	34.85	Paper Holder	6
YB2218CH	42.90	18" Towel Bar	6
YB2224CH	45.10	24" Towel Bar	6
YB2286CH	26.65	Towel Ring	6
Brushed Nickel (BN)			
YB2201BN	46.25	Toilet Tank Lever	6
YB2203BN	32.75	Double Robe Hook	24
YB2208BN	58.75	Paper Holder	6
YB2218BN	72.15	18" Towel Bar	6
YB2224BN	75.80	24" Towel Bar	6
YB2286BN	44.70	Towel Ring	6
Oil Rubbed Bronze (ORB)			
YB2201ORB	46.25	Toilet Tank Lever	6
YB2203ORB	32.75	Double Robe Hook	24
YB2208ORB	58.75	Paper Holder	6
YB2218ORB	72.15	18" Towel Bar	6
YB2224ORB	75.80	24" Towel Bar	6
YB2286ORB	44.70	Towel Ring	6
Miscellaneous			
YB8081	16.30	Pro-Fit® Installation Mounting Template	25

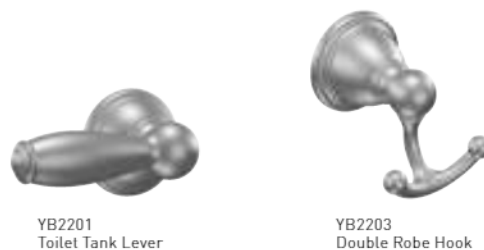

YB2201 Toilet Tank Lever

YB2203 Double Robe Hook



YB2208 Paper Holder

YB2218 18" Towel Bar



YB2224 24" Towel Bar

YB2286 Towel Ring

GRAB BARS

PERFECTLY MATCHED to Moen® Brantford™ faucets and bath accessories. ADA-compliant.



SecureMount™ Grab Bars are manufactured with an innovative flange design that makes it easy to connect to the stud at multiple points.

To install grab bars securely without studs, use SecureMount™ Anchors. Sold separately.

MODEL NUMBER	LIST PRICE EACH	DESCRIPTION	QTY
1-1/4" • Chrome (CH)			
YG2212CH	98.05	12" Grab Bar	6
YG2218CH	103.60	18" Grab Bar	6
YG2224CH	108.40	24" Grab Bar	6
1-1/4" • Brushed Nickel (BN)			
YG2212BN	119.50	12" Grab Bar	6
YG2218BN	125.50	18" Grab Bar	6
YG2224BN	136.00	24" Grab Bar	6
1-1/4" • Oil Rubbed Bronze (ORB)			
YG2212ORB	130.65	12" Grab Bar	6
YG2218ORB	137.35	18" Grab Bar	6
YG2224ORB	151.60	24" Grab Bar	6
SecureMount Anchors™			
SMA1005CH	21.20	SecureMount Anchors™ (1 pc Chrome Mounting Plates)	3
SMA1000WB	48.80	SecureMount Anchors™ (2 pc Old World Bronze Mounting Plates)	24



YG2224 24" length Grab Bar



YB8081 Pro-Fit® Installation Mounting Template (See page 54 for more information about the Pro-Fit® Installation System).



Complies with Americans with Disabilities Act (ADA) specifications. SecureMount™ Grab Bars are tested to withstand 500 lb. pull when securely installed per instructions.

BRANTFORD™

BRANTFORD™ Perfectly Matched Bath Accessories



BRANTFORD™

LIGHTING

MODEL NUMBER	LIST PRICE EACH	DESCRIPTION	QTY
Chrome (CH)			
YB2261CH	152.85	One-Globe Light	2
YB2262CH	213.95	Two-Globe Light	2
YB2263CH	234.90	Three-Globe Light	2
YB2264CH	320.85	Four-Globe Light	2
Brushed Nickel (BN)			
YB2261BN	191.00	One-Globe Light	2
YB2262BN	267.30	Two-Globe Light	2
YB2263BN	293.70	Three-Globe Light	2
YB2264BN	400.90	Four-Globe Light	2
Oil Rubbed Bronze (ORB)			
YB2261ORB	191.00	One-Globe Light	2
YB2262ORB	267.30	Two-Globe Light	2
YB2263ORB	293.70	Three-Globe Light	2
YB2264ORB	400.90	Four-Globe Light	2



YB2261
One-Globe Light



YB2262
Two-Globe Light



YB2263
Three-Globe Light



YB2264
Four-Globe Light















Bulbs not included.

All Brantford™ lighting fixtures can be mounted with globes either facing upward or downward.

EVA® Bathroom Faucets

All Brushed Nickel faucet components feature the LifeShine® Non-Tarnish Finish.

		MODEL NUMBER	LIST PRICE	FINISH/ CONNECTION	CASE QTY
ONE-HANDLE BATHROOM FAUCET					
 <ul style="list-style-type: none"> • application: one or three hole • supply line length: flexible • connection size: 3/8" • connection type: compression • deck plate: included • drain assembly: metal • drain assembly type: lift rod   DURALAST™		6400	281.20	Chrome	3
		6400BN	394.45	Brushed Nickel	3
		6400ORB	394.45	Oil Rubbed Bronze	3
 <ul style="list-style-type: none"> • description: vessel extension kit • includes: two 2.5" extensions • includes: parts to convert to grid drain 		A1717	138.45	Chrome	6
		A1717BN	224.65	Brushed Nickel	6
		A1717ORB	224.65	Oil Rubbed Bronze	6
TWO-HANDLE BATHROOM FAUCET					
 <ul style="list-style-type: none"> • application: three hole • centre dimensions: 4" centre • connection size: 1/2" • connection type: IPS • drain assembly: metal • drain assembly type: lift rod  		6410	210.15	Chrome	6
		6410BN	300.80	Brushed Nickel	6
		6410ORB	300.80	Oil Rubbed Bronze	6
TWO-HANDLE WIDESPREAD BATHROOM FAUCET					
 <ul style="list-style-type: none"> • application: three hole • centre dimensions: 8" - 16" centre • drain assembly: metal • drain assembly type: lift rod • valve sold separately   		T6420	223.90	Chrome	3
		T6420BN	352.00	Brushed Nickel	3
		T6420ORB	352.00	Oil Rubbed Bronze	3
 <ul style="list-style-type: none"> • application: three hole • centre dimensions: 8" - 16" centre • drain assembly: metal • drain assembly type: lift rod  DURALOCK® DURALAST®		9000	148.70	1/2" IPS	6

HOW TO ORDER A COMPLETE BATHROOM FAUCET

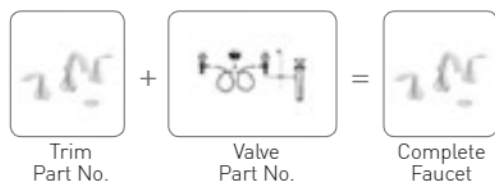







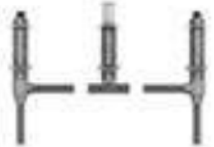

NOTES

-  Moen® **M•PACT®** Common Valve System
- DURALOCK®** Duralock™ Quick Connections
- DURALAST®** Duralast® Cartridge

EVA® Roman Tub

All Brushed Nickel faucet components feature the LifeShine® Non-Tarnish Finish.

	MODEL NUMBER	LIST PRICE	FINISH/ CONNECTION	CASE QTY
TWO-HANDLE ROMAN TUB				
 <ul style="list-style-type: none"> • application: three hole • spout reach: 7.67" • valve sold separately 	T943 T943BN T943ORB	312.80 515.65 515.65	Chrome Brushed Nickel Oil Rubbed Bronze	3 3 3
 <ul style="list-style-type: none"> • application: three hole • deck thickness: 1/8" to 3-3/8" rough deck • centre dimensions: adjustable • adjustable spout shank: included • test plug: included 	4792	188.00	1/2" CC	6
 <ul style="list-style-type: none"> • application: three hole • deck thickness: 1/8" to 1-7/8" deck • centre dimensions: 10" centre • non-adjustable spout shank: included • test plug: included 	4796 4798	179.95 179.95	1/2" CC 1/2" PEX, Cold Expansion PEX	6 6
 <ul style="list-style-type: none"> • description: high flow thermostatic mixing valve • 1/2" FNPT (3/8" compression adapters) • listed to ASSE Standard 1070 • max. flow rate at 45 psi = 10 gpm • tub application 	104465	223.55	1/2" FNPT	12
 <ul style="list-style-type: none"> • description: PEX transition fittings (2) and clips • adapts standard 1/2" PEX barb to 1/2" PEX cold expansion connections 	140715	11.35	1/2" PEX	200



HOW TO ORDER A COMPLETE ROMAN TUB FAUCET

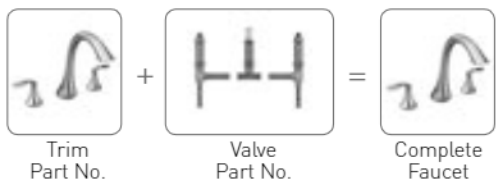







NOTES

 Moen® **M•PACT®** Common Valve System

EVA® Roman Tub

All Brushed Nickel faucet components feature the LifeShine® Non-Tarnish Finish.

	MODEL NUMBER	LIST PRICE	FINISH/ CONNECTION	CASE QTY
TWO-HANDLE ROMAN TUB WITH HANDSHOWER				
 <ul style="list-style-type: none"> • application: four hole • showerhead type: handshower • handshower functions: one-function • handshower flow rate: 1.75 gpm (6.65 L/min) max. • spout reach: 7.67" • valve sold separately 	T944	516.85	Chrome	3
	T944BN	769.30	Brushed Nickel	3
	T944ORB	769.30	Oil Rubbed Bronze	3
 <ul style="list-style-type: none"> • application: four hole • deck thickness: 1/8" to 2-5/8" deck • centre dimensions: 10" centre • non-adjustable spout shank: included • test plug: included 	9796	358.95	1/2" CC	6
	9797	358.95	1/2" CPVC, PEX	6
 <ul style="list-style-type: none"> • description: high flow thermostatic mixing valve • 1/2" FNPT (3/8" compression adapters) • listed to ASSE Standard 1070 • max. flow rate at 45 psi = 10 gpm • tub application 	104465	223.55	1/2" FNPT	12
 <ul style="list-style-type: none"> • description: PEX transition fittings (2) and clips • adapts standard 1/2" PEX barb to 1/2" PEX cold expansion connections 	140715	11.35	1/2" PEX	200

EVA®

HOW TO ORDER A COMPLETE ROMAN TUB FAUCET

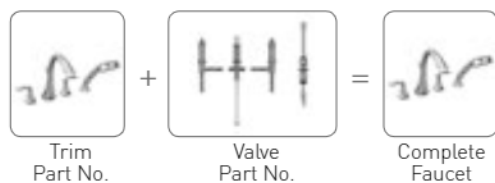











NOTES

 Moen® **M•PACT®** Common Valve System

EVA® Posi-Temp® Showering

All Brushed Nickel faucet components feature the LifeShine® Non-Tarnish Finish.

		MODEL NUMBER	LIST PRICE	FINISH/ CONNECTION	CASE QTY
POSI-TEMP® TUB/SHOWER					
	<ul style="list-style-type: none"> • showerhead functions: one-function • showerhead type: standard • showerhead size: 3-3/8" diameter spray head • showerhead flow rate: 2.5 gpm (9.5 L/min) max. • spout length: 7" • spout connection type: slip fit • tub spout type: diverter • valve sold separately 	T2133	135.30	Chrome	3
		T2133BN	288.15	Brushed Nickel	3
		T2133ORB	288.15	Oil Rubbed Bronze	3
					
	<ul style="list-style-type: none"> • showerhead functions: one-function • showerhead type: eco-performance showerhead • showerhead size: 3-3/8" diameter spray head • showerhead flow rate: 1.75 gpm (6.65 L/min) max. • spout length: 7" • spout connection type: slip fit • tub spout type: diverter • valve sold separately 	T62133EP	135.30	Chrome	12
		T2133EPBN	288.15	Brushed Nickel	3
		T2133EPORB	288.15	Oil Rubbed Bronze	3
					
	<ul style="list-style-type: none"> • showerhead functions: one-function • showerhead type: eco-performance rainshower • showerhead size: 8" diameter spray head • showerhead flow rate: 1.75 gpm (6.65 L/min) max. • spout length: 7" • spout connection type: slip fit • tub spout type: diverter • valve sold separately 	T2233EP	204.60	Chrome	4
		T2233EPBN	385.05	Brushed Nickel	4
		T2233EPORB	385.05	Oil Rubbed Bronze	4
					
	<ul style="list-style-type: none"> • ports: four • adjustable temperature limit stop: included 	2510	152.20	1/2" IPS	6
		2520	152.20	1/2" CC	6
					
	<ul style="list-style-type: none"> • ports: four • adjustable temperature limit stop: included • quarter turn stops: included 	2570	194.75	1/2" CC	6
		2590	194.75	1/2" IPS	6
					

HOW TO ORDER A COMPLETE TUB/SHOWER FAUCET















NOTES

 Moen® **M•PACT®** Common Valve System



EVA® Posi-Temp® Showering

All Brushed Nickel faucet components feature the LifeShine® Non-Tarnish Finish.

		MODEL NUMBER	LIST PRICE	FINISH/ CONNECTION	CASE QTY
POSI-TEMP® SHOWER ONLY					
	<ul style="list-style-type: none"> • showerhead functions: one-function • showerhead type: standard • showerhead size: 3-3/8" diameter spray head • showerhead flow rate: 2.5 gpm (9.5 L/min) max. • valve sold separately 	T2132	93.80	Chrome	3
		T2132BN	219.10	Brushed Nickel	3
		T2132ORB	219.10	Oil Rubbed Bronze	3
					
	<ul style="list-style-type: none"> • showerhead functions: one-function • showerhead type: eco-performance showerhead • showerhead size: 3-3/8" diameter spray head • showerhead flow rate: 1.75 gpm (6.65 L/min) max. • valve sold separately 	T62132EP	93.80	Chrome	12
		T2132EPBN	219.10	Brushed Nickel	3
		T2132EPORB	219.10	Oil Rubbed Bronze	3
					
	<ul style="list-style-type: none"> • showerhead functions: one-function • showerhead type: eco-performance rainshower • showerhead size: 8" diameter spray head • showerhead flow rate: 1.75 gpm (6.65 L/min) max. • valve sold separately 	T2232EP	163.05	Chrome	4
		T2232EPBN	315.95	Brushed Nickel	4
		T2232EPORB	315.95	Oil Rubbed Bronze	4
					
	<ul style="list-style-type: none"> • ports: four • adjustable temperature limit stop: included 	2510	152.20	1/2" IPS	6
		2520	152.20	1/2" CC	6
					
	<ul style="list-style-type: none"> • ports: four • adjustable temperature limit stop: included • quarter turn stops: included 	2570	194.75	1/2" CC	6
		2590	194.75	1/2" IPS	6
					

EVA®

HOW TO ORDER A COMPLETE SHOWER FAUCET









NOTES

 Moen® **M•FACT®** Common Valve System

EVA® Transfer Valve Shower Spa Components

All Brushed Nickel faucet components feature the LifeShine® Non-Tarnish Finish.

	MODEL NUMBER	LIST PRICE	FINISH/ CONNECTION	CASE QTY
2/3 FUNCTION TRANSFER VALVE ONLY				
 <ul style="list-style-type: none"> • use with 3372 or 3375 transfer valve • valve: sold separately  	T2011	122.55	Chrome	12
	T2011BN	185.65	Brushed Nickel	12
	T2011ORB	185.65	Oil Rubbed Bronze	12
  <ul style="list-style-type: none"> • type of function: two independent one shared • must be used with: Posi-Temp® or Moentrol® valve 	3372	188.30	1/2" CC	12
	  <ul style="list-style-type: none"> • type of function: two independent functions • must be used with: Posi-Temp® or Moentrol® valve 	3375	188.30	1/2" CC



HOW TO ORDER A COMPLETE TRANSFER VALVE















NOTES

 Moen® **M•PACT®** Common Valve System

Refer to specification sheet for critical dimensions for installation.

EVA® Posi-Temp® Showering, Bidets

All Brushed Nickel faucet components feature the LifeShine® Non-Tarnish Finish.

		MODEL NUMBER	LIST PRICE	FINISH/ CONNECTION	CASE QTY
POSI-TEMP® VALVE TRIM					
 <ul style="list-style-type: none"> valve sold separately  		T2131	73.65	Chrome	3
		T2131BN	178.35	Brushed Nickel	3
		T2131ORB	178.35	Oil Rubbed Bronze	3
 <ul style="list-style-type: none"> ports: four adjustable temperature limit stop: included 		2510	152.20	1/2" IPS	6
		2520	152.20	1/2" CC	6
 <ul style="list-style-type: none"> ports: four adjustable temperature limit stop: included quarter turn stops: included 		2570	194.75	1/2" CC	6
		2590	194.75	1/2" IPS	6
TWO-HANDLE BIDET					
 <ul style="list-style-type: none"> valve sold separately  		T5220	429.05	Chrome	3
		T5220BN	626.10	Brushed Nickel	3
		T5220ORB	626.10	Oil Rubbed Bronze	3
 <ul style="list-style-type: none"> application: three hole centre dimensions: 8" - 16" centre  DURALOCK® DURALAST®		9265	319.85	1/2" IPS	6

HOW TO ORDER A COMPLETE VALVE



HOW TO ORDER A COMPLETE BIDET FAUCET

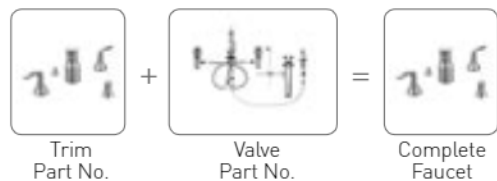

NOTES

-  Moen® **M•PACT®** Common Valve System
- DURALOCK®** Duralock™ Quick Connections
- DURALAST®** Duralast® Cartridge

Moen® makes it easy to coordinate the entire style and look of the bathroom. Our Eva® bath accessories perfectly match the style and finish of our Eva faucets. Total coordination of the bath has never been easier.

MODEL NUMBER	LIST PRICE EACH	DESCRIPTION	QTY
Chrome (CH)			
YB2801CH	27.70	Toilet Tank Lever	6
YB2803CH	24.45	Robe Hook	24
YB2808CH	40.80	Paper Holder	6
YB2818CH	49.00	18" Towel Bar	6
YB2824CH	54.45	24" Towel Bar	6
YB2886CH	32.65	Towel Ring	6
YB2894CH	195.90	Hotel Shelf (26"W x 10.65"D x 7"H)	2
Brushed Nickel (BN)			
YB2801BN	45.65	Toilet Tank Lever	6
YB2803BN	34.10	Robe Hook	24
YB2808BN	61.25	Paper Holder	6
YB2818BN	75.30	18" Towel Bar	6
YB2824BN	79.20	24" Towel Bar	6
YB2886BN	46.70	Towel Ring	6
YB2894BN	236.25	Hotel Shelf (26"W x 10.65"D x 7"H)	2
Oil Rubbed Bronze (ORB)			
YB2801ORB	45.65	Toilet Tank Lever	6
YB2803ORB	34.10	Robe Hook	24
YB2808ORB	61.25	Paper Holder	6
YB2818ORB	75.30	18" Towel Bar	6
YB2824ORB	79.20	24" Towel Bar	6
YB2886ORB	46.70	Towel Ring	6
YB2894ORB	236.25	Hotel Shelf (26"W x 10.65"D x 7"H)	2
Miscellaneous			
YB8081	16.30	Pro-Fit® Installation Mounting Template	25

GRAB BARS

PERFECTLY MATCHED to Moen® Eva® faucets and bath accessories. ADA-compliant.



SecureMount™ Grab Bars are manufactured with an innovative flange design that makes it easy to connect to the stud at multiple points.

To install grab bars securely without studs, use SecureMount™ Anchors. Sold separately.

MODEL NUMBER	LIST PRICE EACH	DESCRIPTION	QTY
1-1/4" • Chrome (CH)			
YG2812CH	98.05	12" Grab Bar	6
YG2818CH	103.60	18" Grab Bar	6
YG2824CH	108.40	24" Grab Bar	6
1-1/4" • Brushed Nickel (BN)			
YG2812BN	119.50	12" Grab Bar	6
YG2818BN	125.50	18" Grab Bar	6
YG2824BN	136.00	24" Grab Bar	6
1-1/4" • Oil Rubbed Bronze (ORB)			
YG2812ORB	130.65	12" Grab Bar	6
YG2818ORB	137.35	18" Grab Bar	6
YG2824ORB	151.59	24" Grab Bar	6
SecureMount Anchors™			
SMA1005CH	21.20	SecureMount Anchors™ (1 pc Chrome Mounting Plates)	3
SMA1000WB	48.80	SecureMount Anchors™ (2 pc Old World Bronze Mounting Plates)	24



YB2801 Toilet Tank Lever

YB2803 Robe Hook



YB2808 Paper Holder



YB2824 24" Towel Bar



YB2886 Towel Ring



YB2818 18" Towel Bar



YB2894 Hotel Shelf (Does not work with Pro-Fit® Installation)



YG2824 24" length Grab Bar



YB8081 Pro-Fit® Installation Mounting Template (See page 54 for more information about the Pro-Fit® Installation System).



Complies with Americans with Disabilities Act (ADA) specifications. SecureMount™ Grab Bars are tested to withstand 500 lb. pull when securely installed per instructions.



EVA®

LIGHTING

MODEL NUMBER	LIST PRICE EACH	DESCRIPTION	QTY
Chrome (CH)			
YB2861CH	152.85	One-Globe Light	2
YB2862CH	213.95	Two-Globe Light	2
YB2863CH	234.90	Three-Globe Light	2
YB2864CH	320.85	Four-Globe Light	2
Brushed Nickel (BN)			
YB2861BN	191.00	One-Globe Light	2
YB2862BN	267.30	Two-Globe Light	2
YB2863BN	293.70	Three-Globe Light	2
YB2864BN	400.90	Four-Globe Light	2
Oil Rubbed Bronze (ORB)			
YB2861ORB	191.00	One-Globe Light	2
YB2862ORB	267.30	Two-Globe Light	2
YB2863ORB	293.70	Three-Globe Light	2
YB2864ORB	400.90	Four-Globe Light	2



YB2861
One-Globe Light

YB2862
Two-Globe Light



YB2863
Three-Globe Light











YB2864
Four-Globe Light



Bulbs not included.

All Eva® lighting fixtures can be mounted with globes either facing upward or downward.

VICHY™ Bathroom Faucets, Roman Tubs

	MODEL NUMBER	LIST PRICE	FINISH/ CONNECTION	CASE QTY
ONE-HANDLE BATHROOM FAUCET				
 <ul style="list-style-type: none"> • application: one hole • supply line length: flexible • connection size: 3/8" • connection type: compression • deck plate: sold separately • drain assembly: metal • drain assembly type: lift rod • red/blue markings: included   DURALAST™	6710	249.80	Chrome	3
		172666	26.15	Chrome
ONE-HANDLE ROMAN TUB WITH HANDSHOWER				
 <ul style="list-style-type: none"> • application: three hole • showerhead type: handshower • handshower functions: one-function • handshower flow rate: 1.75 gpm (6.65 L/min) max. • spout reach: 7.90" • red/blue markings included • valve sold separately  	T967	338.05	Chrome	3
	 <ul style="list-style-type: none"> • application: three hole • deck thickness: 1/8" to 2-5/8" rough deck • centre dimensions: 10" centre • test plug: included 	4791	282.65	1/2" CC
 <ul style="list-style-type: none"> • description: high flow thermostatic mixing valve • 1/2" FNPT (3/8" compression adapters) • listed to ASSE Standard 1070 • max. flow rate at 45 psi = 10 gpm • tub application 	104465	223.55	1/2" FNPT	12

HOW TO ORDER A COMPLETE ROMAN TUB FAUCET

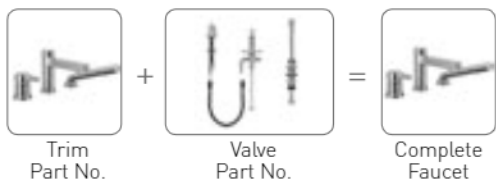









NOTES

 Moen® **M•PACT®** Common Valve System
DURALAST™ Duralast® Cartridge



VICHY™ Posi-Temp® Showering

		MODEL NUMBER	LIST PRICE	FINISH/ CONNECTION	CASE QTY
POSI-TEMP® TUB/SHOWER					
 <ul style="list-style-type: none"> • showerhead functions: one-function • showerhead type: eco-performance showerhead • showerhead size: 3-3/4" diameter spray head • showerhead flow rate: 1.75 gpm (6.65 L/min) max. • spout length: 6" • spout connection type: slip fit • tub spout type: diverter • red/blue markings: included • valve sold separately   		T2663EP	135.30	Chrome	3
 		2510	152.20	1/2" IPS	6
	<ul style="list-style-type: none"> • ports: four • adjustable temp limit stop: included 	2520	152.20	1/2" CC	6
 		2570	194.75	1/2" CC	6
	<ul style="list-style-type: none"> • ports: four • adjustable temp limit stop: included • quarter turn stops: included 	2590	194.75	1/2" IPS	6



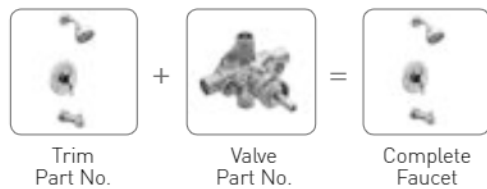



HOW TO ORDER A COMPLETE TUB/SHOWER FAUCET



NOTES

 Moen® **M•PACT®** Common Valve System

VICHY™ Posi-Temp® Showering

		MODEL NUMBER	LIST PRICE	FINISH/ CONNECTION	CASE QTY
POSI-TEMP® SHOWER ONLY					
 <ul style="list-style-type: none"> • showerhead functions: one-function • showerhead type: eco-performance showerhead • showerhead size: 3.75" diameter spray head • showerhead flow rate: 1.75 gpm (6.65 L/min) max. • red/blue markings: included • valve sold separately 		T2662EP	93.80	Chrome	3
 <ul style="list-style-type: none"> • ports: four • adjustable temp limit stop: included 		2510 2520	152.20	1/2" IPS 1/2" CC	6 6
 <ul style="list-style-type: none"> • ports: four • adjustable temp limit stop: included • quarter turn stops: included 		2570 2590	194.75	1/2" CC 1/2" IPS	6 6









HOW TO ORDER A COMPLETE SHOWER FAUCET



NOTES

 Moen® M•PACT® Common Valve System

VICHY™ Posi-Temp® Showering

		MODEL NUMBER	LIST PRICE	FINISH/ CONNECTION	CASE QTY
POSI-TEMP® VALVE TRIM					
 <ul style="list-style-type: none"> • red/blue markings: included • valve sold separately  		T2661	73.65	Chrome	3
 <ul style="list-style-type: none"> • ports: four • adjustable temp limit stop: included 		2510	152.20	1/2" IPS	6
			2520	152.20	1/2" CC
 <ul style="list-style-type: none"> • ports: four • adjustable temp limit stop: included • quarter turn stops: included 		2570	194.75	1/2" CC	6
			2590	194.75	1/2" IPS

VICHY™

HOW TO ORDER A COMPLETE SHOWER FAUCET



NOTES

 Moen® **M•PACT®** Common Valve System

GENTA™ Coordinating Bath Accessories

Moen® makes it easy to coordinate the entire style and look of the bathroom. Our Genta™ bath accessories perfectly match the style and finish of our Vichy™ faucets. Total coordination of the bath has never been easier.

MODEL NUMBER	LIST PRICE EACH	DESCRIPTION	QTY
Chrome (CH)			
BH3803CH	37.25	Single Robe Hook	12
<i>Pivoting</i> BH3808CH	91.25	Pivoting Paper Holder	3
BH3818CH	103.70	18" Towel Bar	3
BH3824CH	115.10	24" Towel Bar	3
BH3886CH	79.40	Hand Towel Bar	3



BH3803
Single Robe Hook



BH3808 *Pivoting*
Pivoting Paper Holder



BH3818
18" Towel Bar



BH3824
24" Towel Bar













BH3886
Hand Towel Bar



METHOD™ Bathroom Faucets

All Brushed Nickel faucet components feature the LifeShine® Non-Tarnish Finish.

	MODEL NUMBER	LIST PRICE	FINISH/ CONNECTION	CASE QTY
ONE-HANDLE BATHROOM FAUCET				
 <ul style="list-style-type: none"> • application: one or three hole • supply line length: flexible • connection size: 3/8" • connection type: compression • deck plate: included • drain assembly: metal • drain assembly type: lift rod   DURALAST™	6810	281.20	Chrome	3
	6810BN	394.45	Brushed Nickel	3
 <ul style="list-style-type: none"> • description: vessel extension kit • includes: two 2.5" extensions • includes: parts to convert to grid drain 	A2020	138.45	Chrome	6
	A2020BN	224.65	Brushed Nickel	6
TWO-HANDLE WIDESPREAD BATHROOM FAUCET				
 <ul style="list-style-type: none"> • application: three hole • centre dimensions: 8" - 16" centre • drain assembly: metal • drain assembly type: lift rod • valve sold separately   	T6820	223.90	Chrome	3
	T6820BN	352.00	Brushed Nickel	3
 <ul style="list-style-type: none"> • application: three hole • centre dimensions: 8" - 16" centre • drain assembly: metal • drain assembly type: lift rod  DURALOCK™ DURALAST™	9000	148.70	1/2" IPS	6

METHOD™

HOW TO ORDER A COMPLETE BATHROOM FAUCET

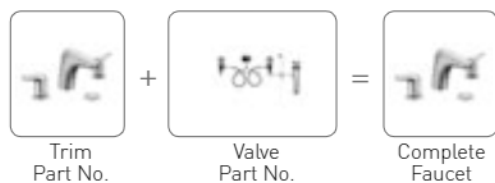









NOTES

-  Moen® **M•PACT**® Common Valve System
- DURALOCK™** Duralock™ Quick Connections
- DURALAST™** Duralast® Cartridge

METHOD™ Roman Tubs

All Brushed Nickel faucet components feature the LifeShine® Non-Tarnish Finish.

	MODEL NUMBER	LIST PRICE	FINISH/ CONNECTION	CASE QTY
TWO-HANDLE ROMAN TUB				
 <ul style="list-style-type: none"> • application: three hole • spout reach: 7.50" • valve sold separately 	T986 T986BN	312.80 515.65	Chrome Brushed Nickel	3 3
 <ul style="list-style-type: none"> • application: three hole • deck thickness: 1/8" to 3-3/8" rough deck • centre dimensions: adjustable • adjustable spout shank: included • test plug: included 	4792	188.00	1/2" CC	6
 <ul style="list-style-type: none"> • application: three hole • deck thickness: 1/8" to 1-7/8" deck • centre dimensions: 10" centre • non-adjustable spout shank: included • test plug: included 	4796 4798	179.95 179.95	1/2" CC 1/2" PEX, Cold Expansion PEX	6 6
 <ul style="list-style-type: none"> • description: high flow thermostatic mixing valve • 1/2" FNPT (3/8" compression adapters) • listed to ASSE Standard 1070 • max. flow rate at 45 psi = 10 gpm • tub application 	104465	223.55	1/2" FNPT	12
 <ul style="list-style-type: none"> • description: PEX transition fittings (2) and clips • adapts standard 1/2" PEX barb to 1/2" PEX cold expansion connections 	140715	11.35	1/2" PEX	200



HOW TO ORDER A COMPLETE ROMAN TUB FAUCET

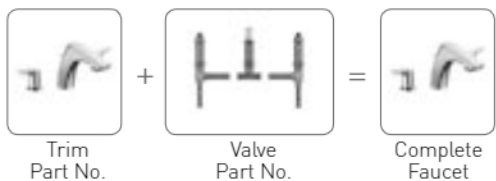







NOTES

 Moen® **M•FACT**® Common Valve System

METHOD™ Roman Tubs

All Brushed Nickel faucet components feature the LifeShine® Non-Tarnish Finish.

	MODEL NUMBER	LIST PRICE	FINISH/ CONNECTION	CASE QTY
TWO-HANDLE ROMAN TUB WITH HANDSHOWER				
 <ul style="list-style-type: none"> • application: four hole • showerhead type: handshower • handshower functions: one-function • handshower flow rate: 1.75 gpm (6.65 L/min) max. • spout reach: 7.50" • valve sold separately 	T987	516.85	Chrome	3
	T987BN	769.30	Brushed Nickel	3
 <ul style="list-style-type: none"> • application: four hole • deck thickness: 1/8" to 2-5/8" deck • centre dimensions: 10" centre • non-adjustable spout shank: included • test plug: included 	9796	358.95	1/2" CC	6
	9797	358.95	1/2" CPVC, PEX	6
 <ul style="list-style-type: none"> • description: high flow thermostatic mixing valve • 1/2" FNPT (3/8" compression adapters) • listed to ASSE Standard 1070 • max. flow rate at 45 psi = 10 gpm • tub application 	104465	223.55	1/2" FNPT	12
 <ul style="list-style-type: none"> • description: PEX transition fittings (2) and clips • adapts standard 1/2" PEX barb to 1/2" PEX cold expansion connections 	140715	11.35	1/2" PEX	200

METHOD™

HOW TO ORDER A COMPLETE ROMAN TUB FAUCET

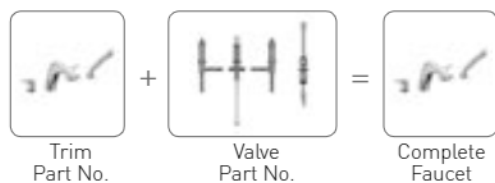









NOTES

 Moen® **M•PACT**® Common Valve System

METHOD™ Posi-Temp® Showering

All Brushed Nickel faucet components feature the LifeShine® Non-Tarnish Finish.

	MODEL NUMBER	LIST PRICE	FINISH/ CONNECTION	CASE QTY
POSI-TEMP® TUB/SHOWER				
 <ul style="list-style-type: none"> • showerhead functions: one-function • showerhead type: standard • showerhead size: 2-1/2" diameter spray head • showerhead flow rate: 2.5 gpm (9.5 L/min) max. • spout length: 5 7/8" • spout connection type: slip fit • tub spout type: diverter • red/blue markings: included • valve sold separately 	T2803	135.30	Chrome	3
	T2803BN	288.15	Brushed Nickel	3
 <ul style="list-style-type: none"> • showerhead functions: one-function • showerhead type: eco-performance showerhead • showerhead size: 2-1/2" diameter spray head • showerhead flow rate: 1.75 gpm (6.65 L/min) max. • spout length: 5 7/8" • spout connection type: slip fit • tub spout type: diverter • red/blue markings: included • valve sold separately 	T62803EP	135.30	Chrome	12
	T2803EPBN	288.15	Brushed Nickel	3
 <ul style="list-style-type: none"> • ports: four • adjustable temperature limit stop: included 	2510	152.20	1/2" IPS	6
	2520	152.20	1/2" CC	6
 <ul style="list-style-type: none"> • ports: four • adjustable temperature limit stop: included • quarter turn stops: included 	2570	194.75	1/2" CC	6
	2590	194.75	1/2" IPS	6



HOW TO ORDER A COMPLETE TUB/SHOWER FAUCET











NOTES

 Moen® **M•PACT®** Common Valve System

METHOD™ Posi-Temp® Showering

All Brushed Nickel faucet components feature the LifeShine® Non-Tarnish Finish.

		MODEL NUMBER	LIST PRICE	FINISH/ CONNECTION	CASE QTY
POSI-TEMP® SHOWER ONLY					
	<ul style="list-style-type: none"> • showerhead functions: one-function • showerhead type: standard • showerhead size: 2-1/2" diameter spray head • showerhead flow rate: 2.5 gpm (9.5 L/min) max. • red/blue markings: included • valve sold separately 	T2802	93.80	Chrome	3
		T2802BN	219.10	Brushed Nickel	3
					
	<ul style="list-style-type: none"> • showerhead functions: one-function • showerhead type: eco-performance showerhead • showerhead size: 2-1/2" diameter spray head • showerhead flow rate: 1.75 gpm (6.65 L/min) max. • red/blue markings: included • valve sold separately 	T62802EP	93.80	Chrome	12
		T2802EPBN	219.10	Brushed Nickel	3
					
	<ul style="list-style-type: none"> • ports: four • adjustable temperature limit stop: included 	2510	152.20	1/2" IPS	6
		2520	152.20	1/2" CC	6
					
	<ul style="list-style-type: none"> • ports: four • adjustable temperature limit stop: included • quarter turn stops: included 	2570	194.75	1/2" CC	6
		2590	194.75	1/2" IPS	6
					

METHOD™

HOW TO ORDER A COMPLETE SHOWER FAUCET









NOTES

 Moen® **M•PACT®** Common Valve System

METHOD™ Posi-Temp® Showering

All Brushed Nickel faucet components feature the LifeShine® Non-Tarnish Finish.

		MODEL NUMBER	LIST PRICE	FINISH/ CONNECTION	CASE QTY
POSI-TEMP® VALVE TRIM					
 <ul style="list-style-type: none"> • red/blue markings: included • valve sold separately  		T2801	73.65	Chrome	3
		T2801BN	178.35	Brushed Nickel	3
 		2510	152.20	1/2" IPS	6
		2520	152.20	1/2" CC	6
 		2570	194.75	1/2" CC	6
		2590	194.75	1/2" IPS	6



HOW TO ORDER A COMPLETE VALVE



NOTES

 Moen® **M•PACT®** Common Valve System

METHOD™ Perfectly Matched Bath Accessories

Moen® makes it easy to coordinate the entire style and look of the bathroom. Our Method™ bath accessories perfectly match the style and finish of our Method faucets. Total coordination of the bath has never been easier.

MODEL NUMBER	LIST PRICE EACH	DESCRIPTION	QTY
Chrome (CH)			
YB2401CH	27.40	Toilet Tank Lever	6
YB2403CH	19.55	Double Robe Hook	24
YB2408CH	34.85	Pivoting Paper Holder	6
YB2418CH	42.90	18" Towel Bar	6
YB2424CH	45.10	24" Towel Bar	6
YB2486CH	26.65	Mini Towel Bar	6
Brushed Nickel (BN)			
YB2401BN	46.25	Toilet Tank Lever	6
YB2403BN	32.75	Double Robe Hook	24
YB2408BN	58.75	Pivoting Paper Holder	6
YB2418BN	72.15	18" Towel Bar	6
YB2424BN	75.80	24" Towel Bar	6
YB2486BN	44.70	Mini Towel Bar	6
Miscellaneous			
YB8081	16.30	Pro-Fit® Installation Mounting Template	25



YB2401
Toilet Tank Lever



YB2403
Double Robe Hook



YB2408
Pivoting Paper Holder



YB2418
18" Towel Bar



YB2424
24" Towel Bar

















YB2486
Mini Towel Bar



YB8081
Pro-Fit® Installation Mounting Template (See page 54 for more information about the Pro-Fit® Installation System).

METHOD™

All Polished Brass faucet components feature the LifeShine® Non-Tarnish Finish.









		MODEL NUMBER	LIST PRICE	FINISH/ CONNECTION	CASE QTY
ONE-HANDLE BATHROOM FAUCET					
	<ul style="list-style-type: none"> • application: three hole • centre dimensions: 4" centre • connection size: 1/2" • connection type: IPS • drain assembly: metal • drain assembly type: lift rod 	L4621	194.05	Chrome	12
		L4621BC	229.90	Brushed Chrome	12
		L4621P	377.20	Polished Brass	12
	 				
<hr/>					
	<ul style="list-style-type: none"> • application: three hole • centre dimensions: 4" centre • supply line length: 16" • connection size: 3/8" • connection type: compression • drain assembly: metal • drain assembly type: lift rod 	L4625	194.05	Chrome	6
	 				
TWO-HANDLE BATHROOM FAUCET					
	<ul style="list-style-type: none"> • application: three hole • centre dimensions: 4" centre • connection size: 1/2" • connection type: IPS • drain assembly: metal • drain assembly type: lift rod 	4925	176.00	Chrome	12
		4925BC	210.10	Brushed Chrome	12
	 				
TWO-HANDLE WIDESPREAD BATHROOM FAUCET					
	<ul style="list-style-type: none"> • application: three hole • centre dimensions: 8" - 16" centre • connection size: 1/2" • connection type: IPS • drain assembly: metal • drain assembly type: lift rod • includes: 9000 valve 	4945	345.95	Chrome	6
	  DURALOCK®				
<hr/>					
	<ul style="list-style-type: none"> • application: three hole • centre dimensions: 8" - 16" centre • connection size: 1/2" • connection type: IPS • drain assembly: metal • drain assembly type: lift rod • includes: 9000 valve 	4962	321.50	Chrome	6
	 DURALOCK®				

CHATEAU®

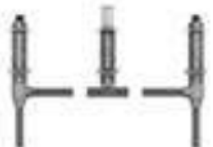
NOTES

DURALOCK® Duralock™ Quick Connections

CHATEAU® Garden Tubs

	MODEL NUMBER	LIST PRICE	FINISH/ CONNECTION	CASE QTY
TWO-HANDLE GARDEN TUB				
 <ul style="list-style-type: none"> • application: three hole • spout reach: 7.00" • valve sold separately 	T994	153.85	Chrome	6
 <ul style="list-style-type: none"> • application: three hole • deck thickness: 1/8" to 3-3/8" rough deck • centre dimensions: adjustable • adjustable spout shank: included • test plug: included 	4792	188.00	1/2" CC	6
 	4796	179.95	1/2" CC	6
	4798	179.95	1/2" PEX, Cold Expansion PEX	6
 <ul style="list-style-type: none"> • description: high flow thermostatic mixing valve • 1/2" FNPT (3/8" compression adapters) • listed to ASSE Standard 1070 • max. flow rate at 45 psi = 10 gpm • tub application 	104465	223.55	1/2" FNPT	12
 <ul style="list-style-type: none"> • description: PEX transition fittings (2) and clips • adapts standard 1/2" PEX barb to 1/2" PEX cold expansion connections 	140715	11.35	1/2" PEX	200





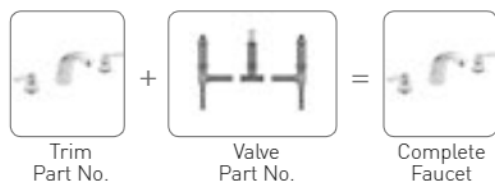





CHATEAU®

HOW TO ORDER A COMPLETE GARDEN TUB FAUCET

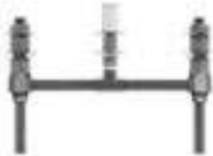

NOTES

 Moen® **M•PACT®** Common Valve System

		MODEL NUMBER	LIST PRICE	FINISH/ CONNECTION	CASE QTY
TWO-HANDLE ROMAN TUB					
 <ul style="list-style-type: none"> • application: three hole • spout reach: 9.00" • valve sold separately 	 	T990	296.05	Chrome	6
		T990BC	368.35	Brushed Chrome	6
 <ul style="list-style-type: none"> • application: three hole • spout reach: 9.00" • valve sold separately 		T999	251.60	Chrome	6
 <ul style="list-style-type: none"> • application: three hole • deck thickness: 1/8" to 3-3/8" rough deck • centre dimensions: adjustable • adjustable spout shank: included • test plug: included 		4792	188.00	1/2" CC	6
 <ul style="list-style-type: none"> • application: three hole • deck thickness: 1/8" to 1-7/8" deck • centre dimensions: 10" centre • non-adjustable spout shank: included • test plug: included 		4796	179.95	1/2" CC	6
		4798	179.95	1/2" PEX, Cold Expansion PEX	6
 <ul style="list-style-type: none"> • description: high flow thermostatic mixing valve • 1/2" FNPT (3/8" compression adapters) • listed to ASSE Standard 1070 • max. flow rate at 45 psi = 10 gpm • tub application 		104465	223.55	1/2" FNPT	12
 <ul style="list-style-type: none"> • description: PEX transition fittings (2) and clips • adapts standard 1/2" PEX barb to 1/2" PEX cold expansion connections 		140715	11.35	1/2" PEX	200





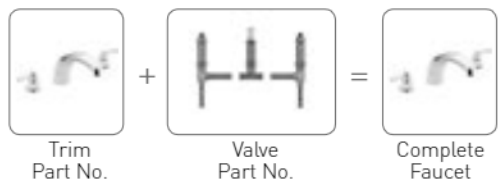







HOW TO ORDER A COMPLETE ROMAN TUB FAUCET



NOTES

 Moen® **M•PACT®** Common Valve System

CHATEAU® Roman Tubs, Bidets

	MODEL NUMBER	LIST PRICE	FINISH/ CONNECTION	CASE QTY
TWO-HANDLE ROMAN TUB WITH HANDSHOWER				
 <ul style="list-style-type: none"> • application: four hole • showerhead type: handshower • handshower functions: one-function • handshower flow rate: 1.75 gpm (6.65 L/min) max. • spout reach: 9.00" • valve sold separately 	T991	379.10	Chrome	6
 <ul style="list-style-type: none"> • application: four hole • deck thickness: 1/8" to 2-5/8" deck • centre dimensions: 10" centre • non-adjustable spout shank: included • test plug: included 	9796 9797	358.95 358.95	1/2" CC 1/2" CPVC, PEX	6 6
 <ul style="list-style-type: none"> • description: high flow thermostatic mixing valve • 1/2" FNPT (3/8" compression adapters) • listed to ASSE Standard 1070 • max. flow rate at 45 psi = 10 gpm • tub application 	104465	223.55	1/2" FNPT	12
 <ul style="list-style-type: none"> • description: PEX transition fittings (2) and clips • adapts standard 1/2" PEX barb to 1/2" PEX cold expansion connections 	140715	11.35	1/2" PEX	200
TWO-HANDLE BIDET				
 <ul style="list-style-type: none"> • application: three hole • centre dimensions: 8"-16" centre 	TL5265	328.55	Chrome	3
 <ul style="list-style-type: none"> • application: three hole • centre dimensions: 8" - 16" centre  DURALOCK® DURALAST®	9265	319.85	1/2" IPS	6

HOW TO ORDER A COMPLETE BIDET FAUCET

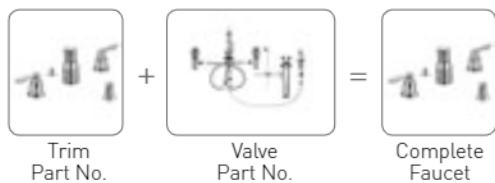



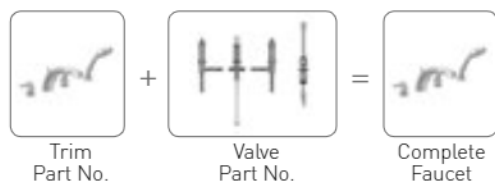





HOW TO ORDER A COMPLETE ROMAN TUB FAUCET



NOTES

-  Moen® **M•PACT®** Common Valve System
- DURALOCK®** Duralock™ Quick Connections
- DURALAST®** Duralast® Cartridge

	MODEL NUMBER	LIST PRICE	FINISH/ CONNECTION	CASE QTY
POSI-TEMP® TUB/SHOWER				
	<ul style="list-style-type: none"> • ports: four • connection size: 1/2" • connection type: CC • showerhead functions: one-function • showerhead type: standard • showerhead size: 2-1/2" diameter spray head • showerhead flow rate: 2.5 gpm (9.5 L/min) max. • spout length: 5 1/2" • spout connection type: slip fit • tub spout type: diverter • red/blue markings: included • adjustable temperature limit stop: included 	2353	236.90 Chrome	12
				
	<ul style="list-style-type: none"> • ports: four • connection size: 1/2" • connection type: CC • showerhead functions: one-function • showerhead type: standard • showerhead size: 2-1/2" diameter spray head • showerhead flow rate: 2.5 gpm (9.5 L/min) max. • spout length: 5 1/2" • spout connection type: slip fit • tub spout type: diverter • red/blue markings: included • adjustable temperature limit stop: included 	L2353	239.45 Chrome	6
 				
	<ul style="list-style-type: none"> • showerhead functions: four-functions • showerhead type: eco-performance showerhead • showerhead size: 4" diameter spray head • type of function: combination; full spray, invigorating spray, targeted massage • flow rate: 1.75 gpm (6.65 L/min) max. • hose length: 59" • double check valve: included • spout length: 5-3/16" • spout connection type: slip fit • tub spout type: diverter • valve: sold separately 	TL2359EP	238.95 Chrome	3
  				



NOTES

Moen® makes it easy to coordinate the entire style and look of the bathroom. Our Mason® bath accessories perfectly match the style and finish of our Chateau® faucets. Total coordination of the bath has never been easier.

MODEL NUMBER	LIST PRICE EACH	DESCRIPTION	QTY
Chrome (CH)			
YB8000CH	10.10	Mounting Posts (Pair)	50
YB8003CH	7.30	Double Robe Hook	50
YB8086CH	11.70	Towel Ring	50
YB8088CH	18.30	Double Paper Holder (3 Mounting Posts, rollers not included)	25
YB8094CH	6.35	24" Towel Bar (Bar only)	50
YB8098CH	5.70	18" Towel Bar (Bar only)	50
YB8099CH	2.65	Paper Holder (Roller only)	50
Brushed Chrome (BC)			
YB8000BC	14.50	Mounting Posts (Pair)	50
YB8003BC	10.10	Double Robe Hook	50
YB8086BC	16.10	Towel Ring	50
YB8094BC	8.00	24" Towel Bar (Bar only)	50
YB8098BC	6.95	18" Towel Bar (Bar only)	50
YB8099BC	4.55	Paper Holder (Roller only)	50
Satin Nickel (SN)			
YB8000SN	11.80	Mounting Posts (Pair)	50
YB8003SN	8.55	Double Robe Hook	50
YB8086SN	17.35	Towel Ring	50
YB8088SN	21.20	Double Paper Holder (3 Mounting Posts, rollers not included)	25
YB8094SN	10.65	24" Towel Bar (Bar only)	50
YB8098SN	8.35	18" Towel Bar (Bar only)	50
YB8099SN	4.45	Paper Holder (Roller only)	50
Old World Bronze (OWB)			
YB8000OWB	15.25	Mounting Posts (Pair)	50
YB8003OWB	9.40	Double Robe Hook	50
YB8086OWB	18.60	Towel Ring	50
YB8094OWB	12.75	24" Towel Bar (Bar only)	50
YB8098OWB	9.80	18" Towel Bar (Bar only)	50
YB8099OWB	3.85	Paper Holder (Roller only)	50
Miscellaneous			
YB8081	16.30	Pro-Fit® Installation Mounting Template	25



YB8003
Double Robe Hook



YB8099
Paper Holder (Roller only)
+
YB8000
Mounting Posts (Pair)



YB8098
18" Towel Bar (Bar only)
+
YB8000
Mounting Posts (Pair)



YB8094
24" Towel Bar (Bar only)
+
YB8000
Mounting Posts (Pair)



YB8086
Towel Ring









YB8088
Double Paper Holder
(3 Mounting Posts, rollers not included)
(Available in CH and SN only)



YB8081
Pro-Fit® Installation Mounting Template [See page 54 for more information about the Pro-Fit® Installation System].







CHATEAU®

MOEN II® Bathroom Faucets

TWO-HANDLE BATHROOM FAUCET		MODEL NUMBER	LIST PRICE	FINISH/ CONNECTION	CASE QTY
 <ul style="list-style-type: none"> • application: three holes • centre dimensions: 4" centre • connection size: 1/2" • includes chainstay • drain assembly sold separately 	74960	94.20	Chrome	12	
 <ul style="list-style-type: none"> • application: three holes • centre dimensions: 4" centre • connection size: 1/2" • includes chainstay • drain assembly sold separately 	74961	94.20	Chrome	12	
 <ul style="list-style-type: none"> • application: three holes • centre dimensions: 4" centre • connection size: 1/2" • includes chainstay • drain assembly sold separately 	74962	94.20	Chrome	12	

MOEN II

MOEN II® Showering

		MODEL NUMBER	LIST PRICE	FINISH/ CONNECTION	CASE QTY
TUB/SHOWER					
	<ul style="list-style-type: none"> • showerhead function: one-function • showerhead type: standard • showerhead size: 2-1/2" diameter spray head • showerhead flow rate: 2.5 gpm (9.5 L/min) max. • spout length: 5-1/2" • spout connection type: slip fit • tub spout type: diverter 	97082	108.50	Chrome	6
	<ul style="list-style-type: none"> • showerhead function: one-function • showerhead type: standard • showerhead size: 2-1/2" diameter spray head • showerhead flow rate: 2.5 gpm (9.5 L/min) max. • spout length: 5-1/2" • spout connection type: slip fit • tub spout type: diverter 	97092	108.50	Chrome	6
	<ul style="list-style-type: none"> • tub/shower, rough-in only • non-pressure balancing • ports: four • connection size: 1/2" • connection type: CC 	72964	98.45	Chrome	12

MOEN II®

Showering extension kits available, see page 372.
 Matching tub and shower drains available. See page 355.

HOW TO ORDER A COMPLETE SHOWER FAUCET



NOTES

 Moen® **M•PACT**® Common Valve System

Custom Showering Options

How-To-Order Spa Shower and Showering Components



U by Moen™ Shower Controller / TS3302TB
Handheld Shower / 3669EPBN



The power of water is in your hands — and in your voice.

U by Moen™ is the digital showering experience that forever transformed showering with the power of personalization. With three ways to control your smart shower — voice, phone and controller — this is water your way. Time your shower to create room in your schedule. Start and pause to control water use. Control the temperature to create the perfect shower before you even step in.

Download U by Moen app:



Compatible with:

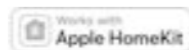

(Ships Q1)

(Ships Q2)



U by Moen™ Shower Options

Due to Department of Energy regulations, plumbing manufacturers can no longer sell vertical spas packaged together as a single SKU. Moen has all the components necessary for you to build a custom Spa Shower a la carte. And, we're making it easy for you to pull together the sku numbers you need. Charts of common spa shower configurations are included so that all the components can be ordered. For additional assistance, call your Moen Sales Representative.



U by MOEN™ Shower Spa with Showerhead, Handshower & Flushmount Body Sprays

Product	Description	QTY.	Chrome	Chrome List Price	Brushed Nickel	Brushed Nickel List Price	Oil Rubbed Bronze	Oil Rubbed Bronze List Price
	U by Moen four-outlet controller	1	TS3304TB	902.50	TS3304TB	902.50	TS3304TB	902.50
	U by Moen four-outlet valve	1	S3104	1,917.00	S3104	1,917.00	S3104	1,917.00
	Rainshower	1	S6310	211.90	S6310BN	315.65	S6310ORB	315.65
	Shower arm & flange	1	S122	50.85	S122BN	96.75	S122ORB	96.75
	Body spray trim	4	TS1322	160.35 x 4	TS1322BN	228.10 x 4	TS1322ORB	228.10 x 4
	Body spray rough-in	4	S1300	106.00 x 4	S1300	106.00 x 4	S1300	106.00 x 4
	Four-function handheld shower with slide bar	1	3667EP	326.55	3667EPBN	745.45	3667EPORB	745.45
	Drop ell	1	A725	63.00	A725BN	90.20	A725ORB	90.20
			Total: \$4,537.20		Total: \$5,403.95		Total: \$5,403.95	

Optional	QTY.	Product	List Price
Battery backup	6	179573	104.70



CUSTOM SHOWERING

U by MOEN™ Shower Spa with Showerhead, Handshower & Exposed Body Sprays

Product	Description	QTY.	Chrome	Chrome List Price	Brushed Nickel	Brushed Nickel List Price	Oil Rubbed Bronze	Oil Rubbed Bronze List Price
	U by Moen four-outlet controller	1	TS3304TB	902.50	TS3304TB	902.50	TS3304TB	902.50
	U by Moen four-outlet valve	1	S3104	1,917.00	S3104	1,917.00	S3104	1,917.00
	Rainshower	1	S6310	211.90	S6310BN	315.65	S6310ORB	315.65
	Shower arm & flange	1	S122	50.85	S122BN	96.75	S122ORB	96.75
	Body spray trim	4	A501	114.70 x 4	A501BN	154.60 x 4	A501ORB	154.60 x 4
	Four-function handheld shower with slide bar	1	3667EP	326.55	3667EPBN	745.45	3667EPORB	745.45
	Drop ell	1	A725	63.00	A725BN	90.20	A725ORB	90.20
			Total: \$3,930.60		Total: \$4,685.95		Total: \$4,685.95	

Optional	QTY.	Product	List Price
Battery backup	6	179573	104.70

U by Moen™ Shower Configurations

		MODEL NUMBER	LIST PRICE	FINISH/ CONNECTION	CASE QTY
U BY MOEN™ SHOWER FOUR-OUTLET CONTROLLER					
 <ul style="list-style-type: none"> description: wifi connected, app driven shower controller showerhead type: showerhead sold separately smart phone app: available for Apple iOS and Android OS features: precise temperature control features: remote activation via smart phone app features: warm-up and pause mode features: optional shower timer presets: two on controller, 12 total with smart phone app valve sold separately 		TS3304TB	902.50	Terra Beige (TB)	3
		NEW TS3304BL	902.50	Matte Black (BL)	-
				  	Ships Q1 Ships Q2
U BY MOEN™ SHOWER FOUR-OUTLET VALVE					
 <ul style="list-style-type: none"> description: digital thermostatic shower valve ports: four outlets features: precise temperature control connection size: 3/4" inlets & 1/2" outlets installation: fits standard 2x4 wall includes: 30 foot data cable 		S3104	1,917.00	3/4" CC / 1/2" CC	3
			179573	104.70	Battery Backup Kit
ACCESSORIES					
U BY MOEN™ SHOWER TWO-OUTLET CONTROLLER					
 <ul style="list-style-type: none"> description: wifi connected, app driven shower controller showerhead type: showerhead sold separately smart phone app: available for Apple iOS and Android OS features: precise temperature control features: remote activation via smart phone app features: warm-up and pause mode features: optional shower timer presets: two on controller, 12 total with smart phone app valve sold separately 		TS3302TB	592.30	Terra Beige (TB)	3
		NEW TS3302BL	592.30	Matte Black (BL)	-
				  	Ships Q1 Ships Q2
U BY MOEN™ SHOWER TWO-OUTLET VALVE					
 <ul style="list-style-type: none"> description: digital thermostatic shower valve ports: two outlets features: precise temperature control connection size: 1/2" inlets & 1/2" outlets installation: fits standard 2x4 wall includes: 30 foot data cable 		S3102	922.15	1/2" CC	3
			179573	104.70	Battery Backup Kit
ACCESSORIES					

CUSTOM SHOWERING

Valve	Flow Rate @ 20 PSI	Flow Rate @ 40 PSI	Flow Rate @ 60 PSI	Used with 2- or 3-Function Transfer	Maximum Components
U by Moen™ S3104	9.0	13.0	16.0	No	4 Components: Any combination of Showerheads, Handshowers and Bodysprays (4 Max)
U by Moen™ S3102	6.0	8.5	10.0	No	Showerhead, Handshower or Showerhead, 2 Bodysprays

U by Moen™ Shower Configurations

Must order Rough-In-Valve and Trim Pack separately.

U by MOEN™ Shower Spa with Showerhead & Flushmount Body Sprays									
Product	Description	QTY.	Chrome	Chrome List Price	Brushed Nickel	Brushed Nickel List Price	Oil Rubbed Bronze	Oil Rubbed Bronze List Price	
	U by Moen two-outlet controller	1	TS3302TB	592.30	TS3302TB	592.30	TS3302TB	592.30	
	U by Moen two-outlet valve	1	S3102	922.15	S3102	922.15	S3102	922.15	
	Rainshower	1	S6310	211.90	S6310BN	315.65	S6310ORB	315.65	
	Shower arm & flange	1	S122	50.85	S122BN	96.75	S122ORB	96.75	
	Body spray trim	3	TS1422	256.60 x 3	TS1422BN	353.50 x 3	TS1422ORB	353.50 x 3	
	Body spray rough-in	3	S1300	106.00 x 3	S1300	106.00 x 3	S1300	106.00 x 3	
Total: \$2,865.00					Total: \$3,305.35			Total: \$3,305.35	
Optional	QTY.	Product	List Price						
Battery backup	6	179573	104.70						

U by MOEN™ Shower Spa with Showerhead & Handshower									
Product	Description	QTY.	Chrome	Chrome List Price	Brushed Nickel	Brushed Nickel List Price	Oil Rubbed Bronze	Oil Rubbed Bronze List Price	
	U by Moen two-outlet controller	1	TS3302TB	592.30	TS3302TB	592.30	TS3302TB	592.30	
	U by Moen two-outlet valve	1	S3102	922.15	S3102	922.15	S3102	922.15	
	Rainshower	1	S6310	211.90	S6310BN	315.65	S6310ORB	315.65	
	Shower arm & flange	1	S122	50.85	S122BN	96.75	S122ORB	96.75	
	Four-function handheld shower with slide bar	1	3667EP	326.55	3667EPBN	745.45	3667EPORB	745.45	
	Drop ell	1	A725	63.00	A725BN	90.20	A725ORB	90.20	
Total: \$2,166.75					Total: \$2,762.50			Total: \$2,762.50	
Optional	QTY.	Product	List Price						
Battery backup	6	179573	104.70						

U by Moen™ Shower Configurations

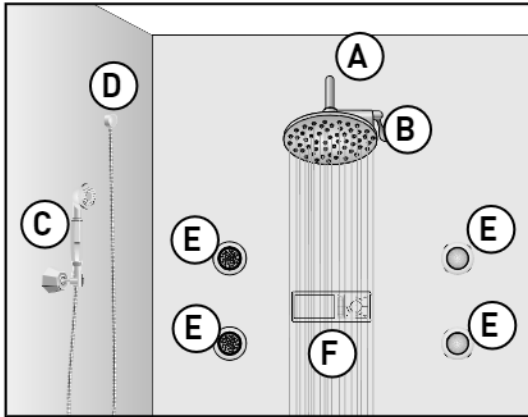

U by Moen™

SHOWER SPA CONFIGURATION-OPTION A

	SKU#	TO ORDER...
A. (1) Shower arm & Flange	S113	See page 346
B. (1) Showerhead	S1311	See page 329
C. (1) Hand Shower	3861EP	See page 341
D. (1) Drop Ell	A725	See page 344
E. (4) Rough-in Body Spray Valves (behind the wall, not shown)	S1300	See page 345
E. (4) Body Spray Trims	TS1322*	See page 345
F. (1) Valve (behind the wall, not shown)	S3104	See page 281
F. (1) Controller	TS3304TB	See page 281

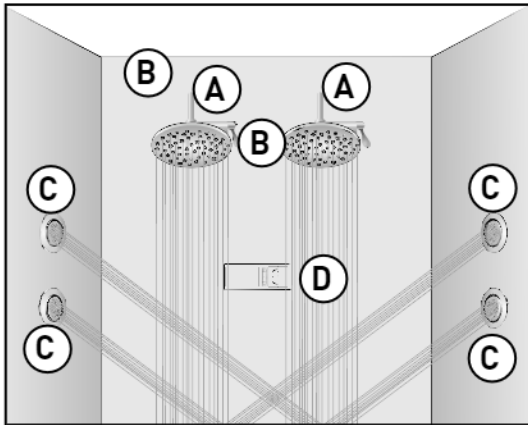

U by Moen™

SHOWER SPA CONFIGURATION-OPTION B

	SKU#	TO ORDER...
A. (2) Shower arms & Flanges	S113	See page 346
B. (2) Showerheads	S1311	See page 329
C. (4) Rough-in Body Spray Valves (behind the wall, not shown)	S1300	See page 345
C. (4) Body Spray Trims	TS1322*	See page 345
D. (1) Valve (behind the wall, not shown)	S3104	See page 281
D. (1) Controller	TS3304TB	See page 281

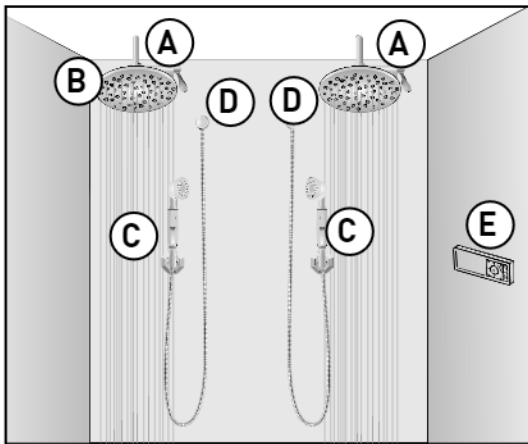

U by Moen™

SHOWER SPA CONFIGURATION-OPTION C

	SKU#	TO ORDER...
A. (2) Shower arm	226651	See page 346
A. (2) Shower arm Flanges	AT2199	See page 347
B. (2) Showerheads	S1311	See page 329
C. (2) Hand Showers	3861EP	See page 341
D. (2) Drop Ells	A725	See page 344
E. (1) Valve (behind the wall, not shown)	S3104	See page 281
E. (1) Controller	TS3304TB	See page 281

*TS1422 Multi-Function body sprays may also be used.

3/4" THERMOSTATIC SHOWERING

ExactTemp® 3/4" Thermostatic Valve and Showering

Due to Department of Energy regulations, plumbing manufacturers can no longer sell vertical spas packaged together as a single SKU. Moen has all the components necessary for you to build a custom vertical spa a la carte. And, we're making it easy for you to pull together the sku numbers you need. Follow the charts below to order all the components in the former vertical spa package offered by Moen.



EXACTTEMP® Vertical Spa Components								
Product	Description	QTY.	Chrome	Chrome List Price	Brushed Nickel	Brushed Nickel List Price	Oil Rubbed Bronze	Oil Rubbed Bronze List Price
	ExactTemp shower only trim	1	TS3400	503.60	TS3400BN	931.55	TS3400ORB	931.55
	ExactTemp valve	1	S3371	626.05	S3371	626.05	S3371	626.05
	Volume control trim	1	TS3600	135.75	TS3600BN	223.90	TS3600ORB	223.90
	Volume control valve	2	S3600	141.15 x 2	S3600	141.15 x 2	S3600	141.15 x 2
	4-Function handheld shower with slide bar	1	3667EP	326.55	3667EPBN	745.45	3667EPORB	745.45
	Drop ell	1	A725	63.00	A725BN	90.20	A725ORB	90.20
			Total: \$1,937.25		Total: \$2,899.45		Total: \$2,899.45	

EXACTTEMP® Vertical Spa Components								
Product	Description	QTY.	Chrome	Chrome List Price	Brushed Nickel	Brushed Nickel List Price	Oil Rubbed Bronze	Oil Rubbed Bronze List Price
	ExactTemp shower only trim	1	TS3400	503.60	TS3400BN	931.55	TS3400ORB	931.55
	ExactTemp valve	1	S3371	626.05	S3371	626.05	S3371	626.05
	Volume control trim	2	TS3600	135.75 x 2	TS3600BN	223.90 x 2	TS3600ORB	223.90 x 2
	Volume control valve	3	S3600	141.15 x 3	S3600	141.15 x 3	S3600	141.15 x 3
	Body spray	4	A501	114.70 x 4	A501BN	154.60 x 4	A501ORB	154.60 x 4
	4-Function handheld shower with slide bar	1	3667EP	326.55	3667EPBN	745.45	3667EPORB	745.45
	Drop ell	1	A725	63.00	A725BN	90.20	A725ORB	90.20
			Total: \$2,672.95		Total: \$3,882.90		Total: \$3,882.90	

EXACTTEMP® Vertical Spa Components								
Product	Description	QTY.	Chrome	Chrome List Price	Brushed Nickel	Brushed Nickel List Price	Oil Rubbed Bronze	Oil Rubbed Bronze List Price
	ExactTemp shower only trim	1	TS3400	503.60	TS3400BN	931.55	TS3400ORB	931.55
	ExactTemp valve	1	S3371	626.05	S3371	626.05	S3371	626.05
	Volume control trim	2	TS3600	135.75 x 2	TS3600BN	223.90 x 2	TS3600ORB	223.90 x 2
	Volume control valve	3	S3600	141.15 x 3	S3600	141.15 x 3	S3600	141.15 x 3
	Body spray trim	4	TS1322	160.35 x 4	TS1322BN	228.10 x 4	TS1322ORB	228.10 x 4
	Body spray rough-in	4	S1300	106.00 x 4	S1300	106.00 x 4	S1300	106.00 x 4
	4-Function handheld shower with slide bar	1	3667EP	326.55	3667EPBN	745.45	3667EPORB	745.45
	Drop ell	1	A725	63.00	A725BN	90.20	A725ORB	90.20
			Total: \$3,279.55		Total: \$4,600.90		Total: \$4,600.90	

CUSTOM SHOWERING

ExactTemp® 3/4" Thermostatic Showering Configurations

Must order Rough-In-Valve and Trim Pack separately.

Thermostatic — Dials in a pinpoint temperature that automatically adjusts to fluctuations in the water supply for a consistent shower, day after day.

Style — Select from a variety of ExactTemp® 3/4" thermostatic trim and individual volume control styles to fulfill your dream shower.

ExactTemp® offers complete design flexibility. Add up to four different types of spray outlets on up to three walls.

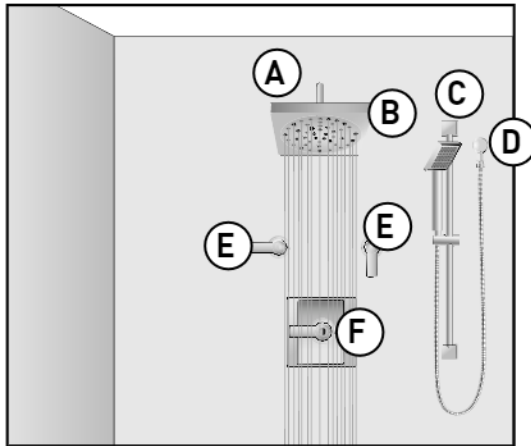

ExactTemp® 3/4" THERMOSTATIC

SHOWER/SPA CONFIGURATION-OPTION A

SKU#

TO ORDER...

- A. (1) Shower arm & Flange S113 See page 346
- B. (1) Showerhead S6340 See page 332
- C. (1) Hand Shower S3879EP See page 338
- D. (1) Drop Ell A721 See page 344
- E. (2) Volume Control Valves S3600 See page 105
- E. (2) Volume Controls Trims TS3300 See page 288
- F. (1) ExactTemp® Valve S3371 See page 105
- F. (1) ExactTemp® Trim TS3100 See page 288

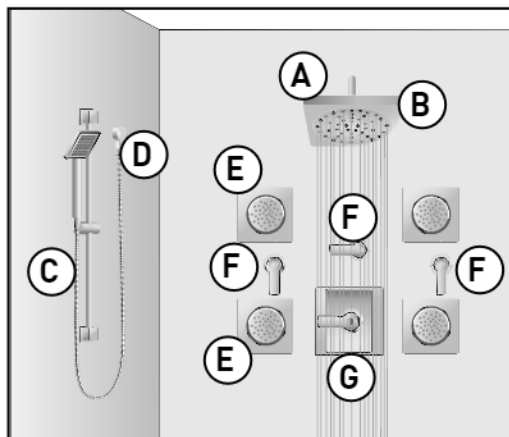

ExactTemp® 3/4" THERMOSTATIC

SHOWER/SPA CONFIGURATION-OPTION B

SKU#

TO ORDER...

- A. (1) Shower arm & Flange S113 See page 346
- B. (1) Showerhead S6340 See page 332
- C. (1) Hand Shower S3879EP See page 338
- D. (1) Drop Ell A721 See page 344
- E. (4) Rough-in Body Spray Valves S1300 See page 345
- E. (4) Body Spray Trims TS1320 See page 345
- F. (3) Volume Control Valves S3600 See page 105
- F. (3) Volume Control Trims TS3300 See page 288
- G. (1) ExactTemp® Valve S3371 See page 105
- G. (1) ExactTemp® Trim TS3100 See page 288

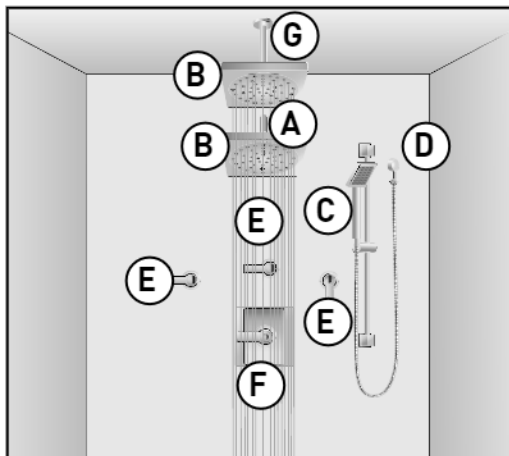

ExactTemp® 3/4" THERMOSTATIC

SHOWER/SPA CONFIGURATION-OPTION C

SKU#

TO ORDER...

- A. (1) Shower arm & Flange S113 See page 346
- B. (2) Showerheads S6340 See page 332
- C. (1) Hand Shower S3879EP See page 338
- D. (1) Drop Ell A721 See page 344
- E. (3) Volume Control Valves S3600 See page 105
- E. (3) Volume Control Trims TS3300 See page 288
- F. (1) ExactTemp® Valve S3371 See page 105
- F. (1) ExactTemp® Trim TS3100 See page 288
- G. (1) Shower arm 226651 See page 346
- G. (1) Shower arm Flange AT2199 See page 347

CUSTOM SHOWERING

Valve	Flow Rate through shower port (GPM) @ 20 PSI	Flow Rate through shower port (GPM) @ 40 PSI	Flow Rate through shower port (GPM) @ 60 PSI	Used with 2- or 3-Function Transfer	Maximum Components
3/4" ExactTemp® S3371	11.4	15.7	18.0	No	4 Components: Any combination of Showerheads, Handshowers and Bodysprays (4 Max)

ExactTemp® 3/4" Thermostatic Showering Configurations

Must order Rough-In-Valve and Trim Pack separately.

All Brushed Nickel, Polished Nickel, Polished Brass and Brushed Gold faucet components feature the Lifeshine® Non-Tarnish Finish.

	MODEL NUMBER	LIST PRICE	FINISH/ CONNECTION	CASE QTY
--	--------------	------------	--------------------	----------

EXACTTEMP® VALVE ONLY



- ports: four
- adjustable temperature limit stop: included
- check stops included
- requires separate volume control valve
- thermostatic valve



S3371	626.05	3/4" IPS	6
--------------	--------	----------	---

VOLUME CONTROL VALVE ONLY



- volume control valve



S3600	141.15	3/4" IPS	12
--------------	--------	----------	----

EXACTTEMP® SHOWER ONLY



- showerhead functions: one-function
- showerhead type: rainshower
- showerhead size: 7" diameter spray head
- showerhead flow rate: 2.5 gpm (9.5 L/min) max.
- valve sold separately



IMMERSION

TS3400	503.60	Chrome	3
TS3400BN	931.55	Brushed Nickel	3
TS3400ORB	931.55	Oil Rubbed Bronze	3

TWIN ELL



- description: twin ell
- usage: with ExactTemp tub/shower installations

128284	32.75		12
---------------	-------	--	----

CUSTOM SHOWERING

Diverter tub spout options on page 349 - page 352.

Showering extension kits available on page 372.

Matching tub and shower drains available. See page 355.

Valve	Flow Rate through shower port (GPM) @ 20 PSI	Flow Rate through shower port (GPM) @ 40 PSI	Flow Rate through shower port (GPM) @ 60 PSI	Used with 2- or 3-Function Transfer	Maximum Components
3/4" ExactTemp® S3371	11.4	15.7	18.0	No	4 Components: Any combination of Showerheads, Handshowers and Bodsprays (4 Max)

HOW TO ORDER A COMPLETE TUB/SHOWER FAUCET















NOTES

Moen® **M•PACT**® Common Valve System
 Immersion® Rainshower

ExactTemp® 3/4" Thermostatic Showering Configurations

Must order Rough-In-Valve and Trim Pack separately.

All Brushed Nickel, Polished Nickel, Polished Brass and Brushed Gold faucet components feature the Lifeshine® Non-Tarnish Finish.

		MODEL NUMBER	LIST PRICE	FINISH/ CONNECTION	CASE QTY
WEYMOUTH®   	EXACTTEMP® VALVE TRIM				
	• valve sold separately	TS32110	373.75	Chrome	3
		TS32110BN	552.25	Brushed Nickel	3
		TS32110NL	552.25	Polished Nickel	3
		TS32110ORB	552.25	Oil Rubbed Bronze	3
		NEW! TS32110BG	552.25	Brushed Gold	3
		NEW! TS32110BL*	552.25	Matte Black	-
WEYMOUTH®   	VOLUME CONTROL VALVE TRIM				
	• valve sold separately	TS52104	173.40	Chrome	6
		TS52104BN	244.20	Brushed Nickel	6
		TS52104NL	244.20	Polished Nickel	6
		TS52104ORB	244.20	Oil Rubbed Bronze	6
		NEW! TS52104BG	244.20	Brushed Gold	6
		NEW! TS52104BL*	244.20	Matte Black	-
ARRIS®   	EXACTTEMP® VALVE TRIM				
	• valve sold separately	TS33002	373.75	Chrome	3
		TS33002BN	552.25	Brushed Nickel	3
		NEW! TS33002BL*	552.25	Matte Black	-
ARRIS®   	VOLUME CONTROL VALVE TRIM				
	• valve sold separately	TS33003	173.40	Chrome	6
		TS33003BN	244.20	Brushed Nickel	6
		NEW! TS33003BL*	244.20	Matte Black	-

CUSTOM SHOWERING

HOW TO ORDER A COMPLETE SHOWER FAUCET

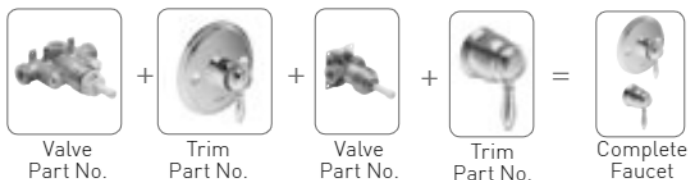

NOTES





 Moen® M•PACT® Common Valve System

*Ships Q2

ExactTemp® 3/4" Thermostatic Showering Configurations

Must order Rough-In-Valve and Trim Pack separately.

All Brushed Nickel, Polished Nickel, Polished Brass and Brushed Gold faucet components feature the Lifeshine® Non-Tarnish Finish.

		MODEL NUMBER	LIST PRICE	FINISH/ CONNECTION	CASE QTY
	WATERHILL®	EXACTTEMP® VALVE TRIM			
		• valve sold separately			
		TS3110	336.30	Chrome	3
		TS3110BN	524.75	Brushed Nickel	3
		TS3110ORB	524.75	Oil Rubbed Bronze	3
	WATERHILL®	VOLUME CONTROL VALVE TRIM			
		• valve sold separately			
		TS514	160.90	Chrome	6
		TS514BN	231.95	Brushed Nickel	6
		TS514ORB	231.95	Oil Rubbed Bronze	6
	90 DEGREE™	EXACTTEMP® VALVE TRIM			
		• valve sold separately			
		TS3100	303.50	Chrome	3
		TS3100BN	490.85	Brushed Nickel	3
	90 DEGREE™	VOLUME CONTROL VALVE TRIM			
		• valve sold separately			
		TS3300	136.45	Chrome	6
		TS3300BN	220.05	Brushed Nickel	6



CUSTOM SHOWERING













NOTES

Moens M-PACT Common Valve System

ExactTemp® 3/4" Thermostatic Showering Configurations

Must order Rough-In-Valve and Trim Pack separately.

All Brushed Nickel, Polished Nickel, Polished Brass and Brushed Gold faucet components feature the Lifeshine® Non-Tarnish Finish.

		MODEL NUMBER	LIST PRICE	FINISH/ CONNECTION	CASE QTY
ROTHBURY™ 	EXACTTEMP® VALVE TRIM				
	• valve sold separately	TS3760	303.50	Chrome	3
		TS3760BN	490.85	Brushed Nickel	3
		TS3760ORB	490.85	Oil Rubbed Bronze	3
					
ROTHBURY™ 	VOLUME CONTROL VALVE TRIM				
	• valve sold separately	TS3820	136.45	Chrome	6
		TS3820BN	220.05	Brushed Nickel	6
		TS3820ORB	220.05	Oil Rubbed Bronze	6
					
ICON™ 	EXACTTEMP® VALVE TRIM				
	• valve sold separately	TS3900	290.80	Chrome	3
		TS3900BN	485.65	Brushed Nickel	3
					
ICON™ 	VOLUME CONTROL VALVE TRIM				
	• valve sold separately	TS3200	134.40	Chrome	6
		TS3200BN	218.85	Brushed Nickel	6
					
VIA® 	EXACTTEMP® VALVE ONLY				
	<ul style="list-style-type: none"> • description: temperature control valve trim • requires: separate volume control valve • valve: sold separately 	TS9711	303.50	Chrome	3
					
VIA® 	EXACTTEMP® VOLUME CONTROL VALVE ONLY				
	• valve sold separately	TS9712	136.45	Chrome	6
					

CUSTOM SHOWERING

NOTES

 Moen® M•PACT® Common Valve System

ExactTemp® 3/4" Thermostatic Showering Configurations

Must order Rough-In-Valve and Trim Pack separately.

All Brushed Nickel, Polished Nickel, Polished Brass and Brushed Gold faucet components feature the Lifeshine® Non-Tarnish Finish.

		MODEL NUMBER	LIST PRICE	FINISH/ CONNECTION	CASE QTY
	EXACTTEMP® VALVE ONLY <ul style="list-style-type: none"> description: temperature control valve trim requires: separate volume control valve valve: sold separately 	TS3101	336.30	Chrome	3
		TS3101BN	524.75	Brushed Nickel	3
		TS3101BL	524.75	Matte Black	3
	VOLUME CONTROL VALVE ONLY <ul style="list-style-type: none"> valve sold separately 	TS3102	160.90	Chrome	6
		TS3102BN	231.95	Brushed Nickel	6
		TS3102BL	231.95	Matte Black	6
	EXACTTEMP® VALVE ONLY <ul style="list-style-type: none"> description: temperature control valve trim description: temperature control valve trim requires: separate volume control valve valve: sold separately 	T6601	280.00	Chrome	3
		T6601BN	472.30	Brushed Nickel	3
		T6601NL	472.30	Polished Nickel	3
		T6601ORB	472.30	Oil Rubbed Bronze	3
	VOLUME CONTROL VALVE ONLY <ul style="list-style-type: none"> valve sold separately 	T6602	129.45	Chrome	6
		T6602BN	212.85	Brushed Nickel	6
		T6602NL	212.85	Polished Nickel	6
		T6602ORB	212.85	Oil Rubbed Bronze	6
	EXACTTEMP® VALVE ONLY <ul style="list-style-type: none"> description: temperature control valve trim requires: separate volume control valve valve: sold separately 	T4291	280.00	Chrome	3
		T4291BN	472.30	Brushed Nickel	3
		T4291BG	472.30	Brushed Gold	3
		T4291BL	472.30	Matte Black	3
	VOLUME CONTROL VALVE ONLY <ul style="list-style-type: none"> valve sold separately 	T4292	129.45	Chrome	6
		T4292BN	212.85	Brushed Nickel	6
		T4292BG	212.85	Brushed Gold	6
		T4292BL	212.85	Matte Black	6





NOTES

 Moen® **M•PACT®** Common Valve System

ExactTemp® 3/4" Thermostatic Showering Configurations

Must order Rough-In-Valve and Trim Pack separately.

All Brushed Nickel, Polished Nickel, Polished Brass and Brushed Gold faucet components feature the Lifeshine® Non-Tarnish Finish.

		MODEL NUMBER	LIST PRICE	FINISH/ CONNECTION	CASE QTY
BELFIELD™ EXACTTEMP® VALVE ONLY					
 <ul style="list-style-type: none"> • description: temperature control valve trim • requires: separate volume control valve • valve: sold separately 		T4411	280.00	Chrome	3
		T4411BN	472.30	Brushed Nickel	3
		T4411NL*	472.30	Polished Nickel	3
		T4411ORB	472.30	Oil Rubbed Bronze	-
BELFIELD™ VOLUME CONTROL VALVE ONLY					
 <ul style="list-style-type: none"> • valve sold separately 		T4412	129.45	Chrome	6
		T4412BN	212.85	Brushed Nickel	6
		T4412NL*	212.85	Polished Nickel	6
		T4412ORB	212.85	Oil Rubbed Bronze	6
MOEN® EXACTTEMP® VALVE TRIM					
 <ul style="list-style-type: none"> • valve sold separately 		TS3411	286.90	Chrome	3
		TS3411BN	494.75	Brushed Nickel	3
		TS3411ORB	494.75	Oil Rubbed Bronze	3
MOEN® VOLUME CONTROL VALVE TRIM					
 <ul style="list-style-type: none"> • valve sold separately 		TS3600	135.75	Chrome	6
		TS3600BN	223.90	Brushed Nickel	6
		TS3600ORB	223.90	Oil Rubbed Bronze	6

CUSTOM SHOWERING

NOTES

 Moen® M•PACT® Common Valve System

*Ships Q2

MOENTROL® Multi-Function Showering Options

Due to Department of Energy regulations, plumbing manufacturers can no longer sell vertical spas packaged together as a single SKU. Moen has all the components necessary for you to build a custom vertical spa a la carte. And, we're making it easy for you to pull together the sku numbers you need. Follow the charts below to order all the components in the former vertical spa package offered by Moen.



ROTHBURY™ MOENTROL® MULTI-FUNCTION Vertical Spa Components									
Product	Description	QTY.	Chrome	Chrome List Price	Brushed Nickel	Brushed Nickel List Price	Oil Rubbed Bronze	Oil Rubbed Bronze List Price	
	Rothbury multi-function Moentrol trim	1	TS4211	240.15	TS4211BN	359.85	TS4211ORB	359.85	
	3-Function Moentrol valve	1	3330*	352.60	3330*	352.60	3330*	352.60	
	Showerhead	1	S6335	151.15	S6335BN	243.45	S6335ORB	243.45	
	Shower arm	1	10154	12.80	10154BN	32.85	10154ORB	32.85	
	Shower arm flange	1	AT2199	11.50	AT2199BN	30.55	AT2199ORB	30.55	
	Body spray	2	A501	114.70 x2	A501BN	154.60 x2	A501ORB	154.60 x2	
*For 2-Function Moentrol Vertical Spa configurations, use 3350 valve.			Total:	\$997.60	Total:	\$1,328.50	Total:	\$1,328.50	

ROTHBURY™ VERTICAL SPA Showerhead & Hand									
Product	Description	QTY.	Chrome	Chrome List Price	Brushed Nickel	Brushed Nickel List Price	Oil Rubbed Bronze	Oil Rubbed Bronze List Price	
	Rothbury multi-function Moentrol trim	1	TS4211	240.15	TS4211BN	359.85	TS4211ORB	359.85	
	3-Function Moentrol valve	1	3330*	352.60	3330*	352.60	3330*	352.60	
	Showerhead	1	S6335	151.15	S6335BN	243.45	S6335ORB	243.45	
	Shower arm	1	10154	12.80	10154BN	32.85	10154ORB	32.85	
	Drop ell	1	A725	63.00	A725BN	90.20	A725ORB	90.20	
	Shower arm flange	1	AT2199	11.50	AT2199BN	30.55	AT2199ORB	30.55	
	4-Function handheld shower with slide bar	1	3667EP	326.55	3667EPBN	745.45	3667EPORB	745.45	
*For 2-Function Moentrol Vertical Spa configurations, use 3350 valve.			Total:	\$1,157.75	Total:	\$1,854.95	Total:	\$1,854.95	

ICON™ MOENTROL® MULTI-FUNCTION Vertical Spa Components							
Product	Description	QTY.	Chrome	Chrome List Price	Brushed Nickel	Brushed Nickel List Price	
	Icon multi-function Moentrol trim	1	TS4112	229.75	TS4112BN	343.30	
	3-Function Moentrol valve	1	3330*	352.60	3330*	352.60	
	Showerhead	1	S6312	143.80	S6312BN	185.05	
	Shower arm	1	10154	12.80	10154BN	32.85	
	Shower arm flange	1	AT2199	11.50	AT2199BN	30.55	
	Body spray	2	A501	114.70 x2	A501BN	154.60 x2	
*For 2-Function Moentrol Vertical Spa configurations, use 3350 valve.			Total:	\$979.85	Total:	\$1,253.55	

Moentrol® Multi-Function Showering Options

ICON™ VERTICAL SPA with Showerhead and Handshower						
Product	Description	QTY.	Chrome	Chrome List Price	Brushed Nickel	Brushed Nickel List Price
	Icon multi-function Moentrol trim	1	TS4112	229.75	TS4112BN	343.30
	3-Function Moentrol valve	1	3330*	352.60	3330*	352.60
	Showerhead	1	S6312	143.80	S6312BN	185.05
	Shower arm	1	10154	12.80	10154BN	32.85
	Shower arm flange	1	AT2199	11.50	AT2199BN	30.55
	4-Function handheld shower with slide bar	1	3887EP	352.95	3887EPBN	745.45
	Drop ell	1	A725	63.00	A725BN	90.20
				Total: \$1,166.40	Total: \$1,780.00	

*For 2-Function Moentrol Vertical Spa configurations, use 3350 valve.

KINGSLEY® MOENTROL® MULTI-FUNCTION Vertical Spa Components								
Product	Description	QTY.	Chrome	Chrome List Price	Brushed Nickel	Brushed Nickel List Price	Oil Rubbed Bronze	Oil Rubbed Bronze List Price
	Kingsley multi-function Moentrol trim	1	T4111	210.10	T4111BN	317.10	T4111ORB	317.10
	3-Function Moentrol valve	1	3330*	352.60	3330*	352.60	3330*	352.60
	Showerhead	1	6302	113.70	6302BN	152.95	6302ORB	152.95
	Shower arm	1	10154	12.80	10154BN	32.85	10154ORB	32.85
	Shower arm flange	1	AT2199	11.50	AT2199BN	30.55	AT2199ORB	30.55
	Body spray	2	A501	114.70 x 2	A501BN	154.60 x 2	A501ORB	154.60 x 2
				Total: \$930.10	Total: \$1,195.25		Total: \$1,195.25	

*For 2-Function Moentrol Vertical Spa configurations, use 3350 valve.

KINGSLEY® VERTICAL SPA with Showerhead and Handshower								
Product	Description	QTY.	Chrome	Chrome List Price	Brushed Nickel	Brushed Nickel List Price	Oil Rubbed Bronze	Oil Rubbed Bronze List Price
	Kingsley multi-function Moentrol trim	1	T4111	210.10	T4111BN	317.10	T4111ORB	317.10
	3-Function Moentrol valve	1	3330*	352.60	3330*	352.60	3330*	352.60
	Showerhead	1	6302	113.70	6302BN	152.95	6302ORB	152.95
	Shower arm	1	10154	12.80	10154BN	32.85	10154ORB	32.85
	Shower arm flange	1	AT2199	11.50	AT2199BN	30.55	AT2199ORB	30.55
	4-Function handheld shower with slide bar	1	3667EP	326.55	3667EPBN	745.45	3667EPORB	745.45
	Drop ell	1	A725	63.00	A725BN	90.20	A725ORB	90.20
				Total: \$1,090.25	Total: \$1,721.70		Total: \$1,721.70	

*For 2-Function Moentrol Vertical Spa configurations, use 3350 valve.

CUSTOM SHOWERING

Moentrol® Multi-Function Showering Options

With Moentrol®, creating your ideal shower is easy. This valve offers you volume and temperature control, which means you can adjust temperature and flow to your desired level without the worries of hot or cold surges.

Moentrol® with built-in transfer valves allows the user to add a hand shower or body spray to showerhead to create an affordable, custom, multiple-outlet shower experience.

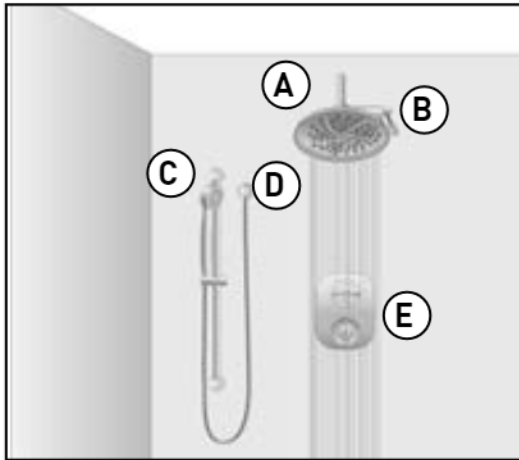

MOENTROL®

MULTI-FUNCTION CONFIGURATION-OPTION A

	SKU#	TO ORDER...
A. (1) Shower arm & Flange	S113	See page 346
B. (1) Showerhead	S1311	See page 329
C. (1) Hand Shower	3667EP	See page 338
D. (1) Drop Ell	A725	See page 344
E. (1) Moentrol® MF Valve	3330	See page 125
E. (1) Moentrol® MF Trim	TS4211	See page 128

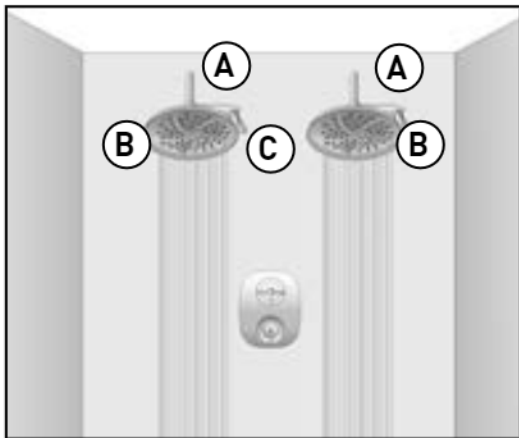



MOENTROL®

MULTI-FUNCTION CONFIGURATION-OPTION B

	SKU#	TO ORDER...
A. (2) Shower arms & Flanges	S113	See page 346
B. (2) Showerheads	S1311	See page 329
C. (1) Moentrol® MF Valve	3330	See page 125
C. (1) Moentrol® MF Trim	TS4211	See page 128

Moentrol® Multi-Function Showering Options

		MODEL NUMBER	LIST PRICE	FINISH/ CONNECTION	CASE QTY
M-PACT® MOENTROL® WITH TRANSFER VALVE ONLY					
	<ul style="list-style-type: none"> • ports: four; two outlets • type of function: two discrete one shared • adjustable temperature limit stop: included • check stops included • includes: volume control • not recommended: for tub spout application 	3320	352.60	1/2" IPS, CC	6
	<ul style="list-style-type: none"> • ports: four; two outlet • type of function: two discrete one shared • adjustable temperature limit stop: included • check stops included • includes: volume control • not recommended: for tub spout application 	3330	352.60	1/2" CC	6
	<ul style="list-style-type: none"> • ports: four; two outlets • type of function: two discrete • adjustable temperature limit stop: included • check stops included • includes: volume control • not recommended: for tub spout application 	3350	352.60	1/2" CC	6

Valve	Flow Rate through shower port (GPM) @ 20 PSI	Flow Rate through shower port (GPM) @ 40 PSI	Flow Rate through shower port (GPM) @ 60 PSI	Used with 2- or 3-Function Transfer	Maximum Components
3-Function Moentrol® 3320, 3330, 3350	*3.0	*4.2	*5.2	No	Showerhead, Handshower or Showerhead, 2 Bodysprays

*3-Function Moentrol® flow is the total flow when used in the shared mode









CUSTOM SHOWERING

NOTES

 Moen® **M•PACT®** Common Valve System

Moentrol® Multi-Function Showering Options

All Brushed Nickel, Polished Nickel, Polished Brass and Brushed Gold faucet components feature the Lifeshine® Non-Tarnish Finish.

		MODEL NUMBER	LIST PRICE	FINISH/ CONNECTION	CASE QTY
ROTHBURY™ MOENTROL® WITH TRANSFER VALVE TRIM					
  	<ul style="list-style-type: none"> valve sold separately 	TS4211	240.15	Chrome	3
		TS4211BN	359.85	Brushed Nickel	3
		TS4211ORB	359.85	Oil Rubbed Bronze	3
ICON™ MOENTROL® WITH TRANSFER VALVE TRIM					
  	<ul style="list-style-type: none"> valve sold separately 	TS4112	229.75	Chrome	3
		TS4112BN	343.30	Brushed Nickel	3
KINGSLEY® MOENTROL® WITH TRANSFER VALVE TRIM					
  	<ul style="list-style-type: none"> valve sold separately 	T4111	210.10	Chrome	3
		T4111BN	317.10	Brushed Nickel	3
		T4111ORB	317.10	Oil Rubbed Bronze	3

CUSTOM SHOWERING

HOW TO ORDER MOENTROL SHOWER WITH TRANSFER VALVE

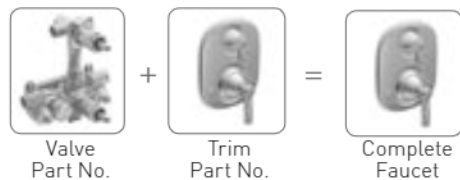

NOTES

 Moen® **M•PACT®** Common Valve System

Moentrol® Shower Spa with Annex™ Shower Rail Showering Components

Due to Department of Energy regulations, plumbing manufacturers can no longer sell vertical spas packaged together as a single SKU. Moen has all the components necessary for you to build a custom Spa Shower a la carte. And, we're making it easy for you to pull together the sku numbers you need. Charts of common spa shower configurations are included so that all the components can be ordered. For additional assistance, call your Moen Sales Representative.



90° Moentrol® Shower Spa with Annex™ Shower Rail				
Product	Description	QTY.	Chrome	Chrome List Price
	90° Moentrol valve only trim	1	TS3711	191.90
	Moentrol valve	1	3570	232.40
	Annex shower rail	1	TS3661NH	561.25
	Rainshower	1	S6340EP	151.15
	One-function handshower	1	176257	105.80
Total: \$1,242.50				

ROTHBURY™ Moentrol® Shower Spa with Annex™ Shower Rail				
Product	Description	QTY.	Chrome	Chrome List Price
	Rothbury Moentrol valve only trim	1	TS3211	191.90
	Moentrol valve	1	3570	232.40
	Annex shower rail	1	TS3661NH	561.25
	Showerhead	1	S6335EP	151.15
	Four-function handshower	1	164927	110.75
Total: \$1,247.45				

ICON™ Moentrol® Shower Spa with Annex™ Shower Rail				
Product	Description	QTY.	Chrome	Chrome List Price
	Icon Moentrol valve only trim	1	TS2154	174.45
	Moentrol valve	1	3570	232.40
	Annex shower rail	1	TS3661NH	561.25
	Showerhead	1	S6312EP	143.80
	One-function handshower	1	155891	88.60
Total: \$1,200.50				

CUSTOM SHOWERING

Moentrol® with Annex™ Shower Rail

WYNFORD® Moentrol® Shower Spa with Annex™ Shower Rail				
Product	Description	QTY.	Chrome	Chrome List Price
	Wynford Moentrol valve only trim	1	T5501	159.60
	Moentrol valve	1	3570	232.40
	Annex shower rail	1	TS3661NH	561.25
	Showerhead	1	S6310EP	211.90
	Four-function handshower	1	164927	110.75
Total:				\$1,275.90

ALIGN® Moentrol® Shower Spa with Annex™ Shower Rail				
Product	Description	QTY.	Chrome	Chrome List Price
	Align Moentrol valve only trim	1	T3291	159.60
	Moentrol valve	1	3570	232.40
	Annex shower rail	1	TS3661NH	561.25
	Showerhead	1	S176EP	212.95
	One-function handshower	1	155891	88.60
Total:				\$1,254.80

VOSS™ Moentrol® Shower Spa with Annex™ Shower Rail				
Product	Description	QTY.	Chrome	Chrome List Price
	Voss Moentrol valve only trim	1	T3691	159.60
	Moentrol valve	1	3570	232.40
	Annex shower rail	1	TS3661NH	561.25
	Showerhead	1	S6365EP	151.15
	Four-function handshower	1	164928	108.70
Total:				\$1,213.10

KINGSLEY® Moentrol® Shower Spa with Annex™ Shower Rail				
Product	Description	QTY.	Chrome	Chrome List Price
	Kingsley Moentrol valve only trim	1	T3111	159.60
	Moentrol valve	1	3570	232.40
	Annex shower rail	1	TS3661NH	561.25
	Showerhead	1	6302EP	113.70
	Four-function handshower	1	164927	110.75
Total:				\$1,177.70

MOENTROL® AND STANDARD Transfer Valve Showering Components

Due to Department of Energy regulations, plumbing manufacturers can no longer sell vertical spas packaged together as a single SKU. Moen has all the components necessary for you to build a custom vertical spa a la carte. And, we're making it easy for you to pull together the sku numbers you need. Follow the charts below to order all the components in the former vertical spa package offered by Moen.



90°™ MOENTROL® WITH 3-FUNCTION TRANSFER VALVE Vertical Spa Components						
Product	Description	QTY.	Chrome	Chrome List Price	Brushed Nickel	Brushed Nickel List Price
	90° Moentrol shower trim	1	TS3715	268.65	TS3715BN	578.85
	Moentrol valve	1	3570	232.40	3570	232.40
	90° 3-Function transfer valve trim	1	TS4173	153.20	TS4173BN	231.85
	3-Function transfer valve	1	3362	215.60	3362	215.60
	90° Handshower with slide bar	1	S3879EP	420.45	S3879EPBN	808.40
	Drop ell	1	A721	71.15	A721BN	101.65
	Non-diverting tub spout	1	S3898	109.50	S3898BN	177.65
				Total: \$1,470.95	Total: \$2,346.40	

WYNFORD™ MOENTROL® WITH 3-FUNCTION TRANSFER VALVE Vertical Spa Components									
Product	Description	QTY.	Chrome	Chrome List Price	Brushed Nickel	Brushed Nickel List Price	Oil Rubbed Bronze	Oil Rubbed Bronze List Price	
	Wynford Moentrol shower trim	1	T5502	250.30	T5502BN	500.25	T5502ORB	500.25	
	Moentrol valve	1	3570	232.40	3570	232.40	3570	232.40	
	Wynford 3-function transfer valve trim	1	T4512	134.25	T4512BN	205.25	T4512ORB	205.25	
	3-Function transfer valve	1	3362	215.60	3362	215.60	3362	215.60	
	Handshower with slide bar	1	3869EP	426.80	3869EPBN	745.45	3869EPORB	745.45	
	Drop ell	1	A725	63.00	A725BN	90.20	A725ORB	90.20	
	Non-diverting tub spout	1	195386	93.90	195386BN	135.90	195386ORB	135.90	
				Total: \$1,416.25	Total: \$2,125.05		Total: \$2,125.05		

VOSS™ MOENTROL® WITH 3-FUNCTION TRANSFER VALVE Vertical Spa Components									
Product	Description	QTY.	Chrome	Chrome List Price	Brushed Nickel	Brushed Nickel List Price	Oil Rubbed Bronze	Oil Rubbed Bronze List Price	
	Voss Moentrol shower trim	1	T3692	250.30	T3692BN	500.25	T3692ORB	500.25	
	Moentrol valve	1	3570	232.40	3570	232.40	3570	232.40	
	Voss 3-function transfer valve trim	1	T4612	134.25	T4612BN	205.25	T4612ORB	205.25	
	3-Function transfer valve	1	3362	215.60	3362	215.60	3362	215.60	
	4-Function handheld with slide bar	1	3667EP	326.55	3667EPBN	745.45	3667EPORB	745.45	
	Drop ell	1	A725	63.00	A725BN	90.20	A725ORB	90.20	
	Non-diverting tub spout	1	191956	95.10	191956BN	136.80	191956ORB	136.80	
				Total: \$1,317.20	Total: \$2,125.95		Total: \$2,125.95		

CUSTOM SHOWERING

Moentrol® Transfer Valve Showering Components

Use the three-function transfer valve with a Moentrol® or Posi-Temp® mixing valve to customize your shower by including hand showers, showerheads, tub spouts, or body sprays in addition to your tub/shower combo.

Now available in eight matching trim suite styles, providing a matching look throughout the bathroom.

ALIGN® MOENTROL® WITH 3-FUNCTION TRANSFER VALVE Vertical Spa Components						
Product	Description	QTY.	Chrome	Chrome List Price	Brushed Nickel	Brushed Nickel List Price
	Align Moentrol shower trim	1	T3292	250.30	T3292BN	500.25
	Moentrol valve	1	3570	232.40	3570	232.40
	Align 3-function transfer valve trim	1	T4192	136.85	T4192BN	205.25
	3-Function transfer valve	1	3362	215.60	3362	215.60
	1-function handshower with slide bar	1	3887EP	352.95	3887EPBN	745.45
	Drop ell	1	A725	63.00	A725BN	90.20
	Non-diverting tub spout	1	3892	87.05	3892BN	124.80
				Total: \$1,338.15	Total: \$2,113.95	

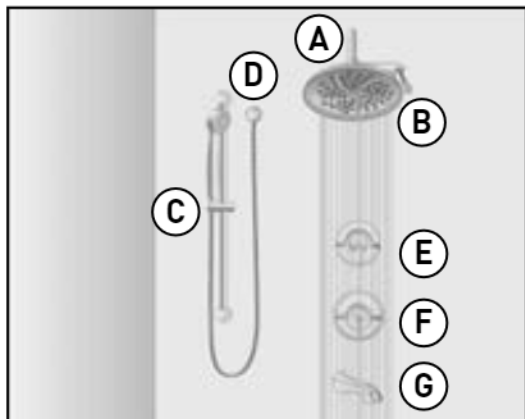

MOENTROL® AND TRANSFER VALVE

SHOWER/SPA CONFIGURATION-OPTION A

	SKU#	TO ORDER...
A. (1) Shower arm & Flange	S113	See page 346
B. (1) Showerhead	S1311	See page 329
C. (1) Hand Shower with Slidebar	3667EP	See page 338
D. (1) Drop Ell	A725	See page 344
E. (1) Transfer Valve	3362	See page 106
(1) Transfer Valve Trim	T4192	See page 165
F. (1) Moentrol® Valve	3520	See page 117
(1) Moentrol® Valve Trim	T3291	See page 167
G. (1) Non-Diverting Tub Spout	3892	See page 354

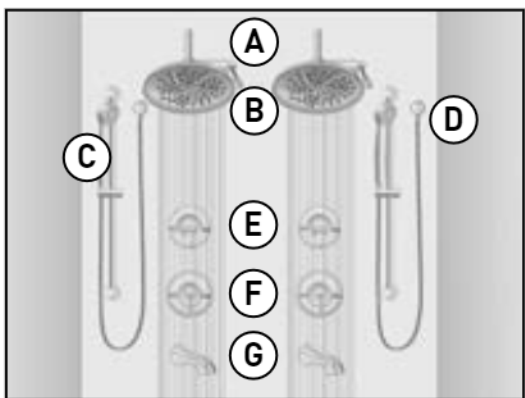

MOENTROL® AND TRANSFER VALVE

SHOWER/SPA CONFIGURATION-OPTION B

	SKU#	TO ORDER...
A. (2) Shower arms & Flanges	S113	See page 346
B. (2) Showerheads	S1311	See page 329
C. (2) Hand Showers	3667EP	See page 338
D. (2) Drop Ells	A725	See page 344
E. (2) Transfer Valves	3362	See page 106
(2) Transfer Valve Trims	T4192	See page 165
F. (2) Moentrol® Valves	3520	See page 117
(2) Moentrol® Valve Trims	T3291	See page 167
G. (2) Non-Diverting Tub Spouts	3892	See page 354

MOENTROL® AND STANDARD Transfer Valve Showering Components

Due to Department of Energy regulations, plumbing manufacturers can no longer sell vertical spas packaged together as a single SKU. Moen has all the components necessary for you to build a custom vertical spa a la carte. And, we're making it easy for you to pull together the sku numbers you need. Follow the charts below to order all the components in the former vertical spa package offered by Moen.



90°™ MOENTROL® WITH 2/3 FUNCTION TRANSFER VALVE Vertical Spa Components						
Product	Description	QTY.	Chrome	Chrome List Price	Brushed Nickel	Brushed Nickel List Price
	90° Moentrol shower trim	1	TS3715	268.65	TS3715BN	578.85
	Moentrol valve	1	3570	232.40	3570	232.40
	90° Transfer valve trim	1	TS4172	147.60	TS4172BN	222.70
	2/3-Function transfer valve	1	3372*	188.30	3372*	188.30
	90° Handshower with slide bar	1	S3879EP	420.45	S3879EPBN	808.40
	Drop ell	1	A721	71.15	A721BN	101.65
				Total: \$1,328.55	Total: \$2,132.30	

*For 2 discrete functions, use 3375 transfer valve.

ROTHBURY™ MOENTROL® WITH 2/3 FUNCTION TRANSFER VALVE Vertical Spa Components									
Product	Description	QTY.	Chrome	Chrome List Price	Brushed Nickel	Brushed Nickel List Price	Oil Rubbed Bronze	Oil Rubbed Bronze List Price	
	Rothbury Moentrol shower trim	1	TS3212	268.65	TS3212BN	578.85	TS3212ORB	578.85	
	Moentrol valve	1	3570	232.40	3570	232.40	3570	232.40	
	Rothbury transfer valve trim	1	TS5205	147.60	TS5205BN	222.70	TS5205ORB	222.70	
	2/3-Function transfer valve	1	3372*	188.30	3372*	188.30	3372*	188.30	
	Handshower with slide bar	1	3869EP	426.80	3869EPBN	745.45	3869EPORB	745.45	
	Drop ell	1	A725	63.00	A725BN	90.20	A725ORB	90.20	
				Total: \$1,326.75	Total: \$2,057.90		Total: \$2,057.90		

*For 2 discrete functions, use 3375 transfer valve.

VOSS™ MOENTROL® WITH 2/3 FUNCTION TRANSFER VALVE Vertical Spa Components									
Product	Description	QTY.	Chrome	Chrome List Price	Brushed Nickel	Brushed Nickel List Price	Oil Rubbed Bronze	Oil Rubbed Bronze List Price	
	Voss Moentrol shower trim	1	T3692	250.30	T3692BN	500.25	T3692ORB	500.25	
	Moentrol valve	1	3570	232.40	3570	232.40	3570	232.40	
	Voss transfer valve trim	1	T4611	128.90	T4611BN	196.20	T4611ORB	196.20	
	2/3-Function transfer valve	1	3372*	188.30	3372*	188.30	3372*	188.30	
	4-Function handheld with slide bar	1	3667EP	326.55	3667EPBN	745.45	3667EPORB	745.45	
	Drop ell	1	A725	63.00	A725BN	90.20	A725ORB	90.20	
				Total: \$1,189.45	Total: \$1,952.80		Total: \$1,952.80		

*For 2 discrete functions, use 3375 transfer valve.

CUSTOM SHOWERING

Moentrol® Transfer Valve Showering Components

Use the three-function or two-function transfer valve with a Moentrol® or Posi-Temp® mixing valve to customize your shower by including hand showers, showerheads, or body sprays in addition to your tub/shower combo.

Now available in six matching trim suite styles or the neutral style that works well with any trim suite of your choice to add flexibility.

ALIGN® MOENTROL® WITH 2/3 FUNCTION TRANSFER VALVE Vertical Spa Components						
Product	Description	QTY.	Chrome	Chrome List Price	Brushed Nickel	Brushed Nickel List Price
	Align Moentrol shower trim	1	T3292	250.30	T3292BN	500.25
	Moentrol valve	1	3570	232.40	3570	232.40
	Align transfer valve trim	1	T4191	128.90	T4191BN	196.20
	2/3-Function transfer valve	1	3372*	188.30	3372*	188.30
	1-function handshower with slide bar	1	3887EP	352.95	3887EPBN	745.45
	Drop ell	1	A725	63.00	A725BN	90.20
				Total: \$1,215.85	Total: \$1,952.80	

*For 2 discrete functions, use 3375 transfer valve.

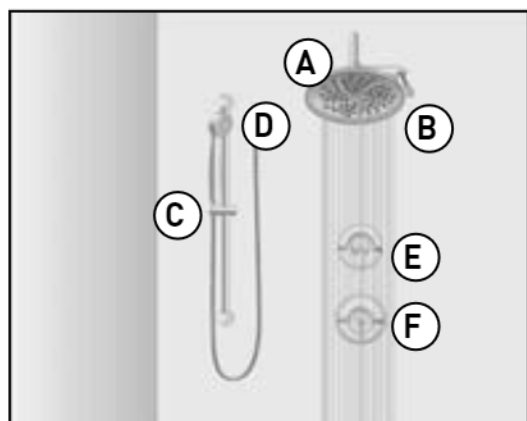

MOENTROL® AND TRANSFER VALVE

SHOWER/SPA CONFIGURATION-OPTION A

	SKU#	TO ORDER...
A. (1) Shower arm & Flange	S113	See page 346
B. (1) Showerhead	S1311	See page 329
C. (1) Hand Shower with Slidebar	3667EP	See page 338
D. (1) Drop Ell	A725	See page 344
E. (1) Transfer Valve	3372	See page 106
(1) Transfer Valve Trim	TS5205	See page 127
F. (1) Moentrol® Valve	3520	See page 117
(1) Moentrol® Valve Trim	TS3211	See page 130

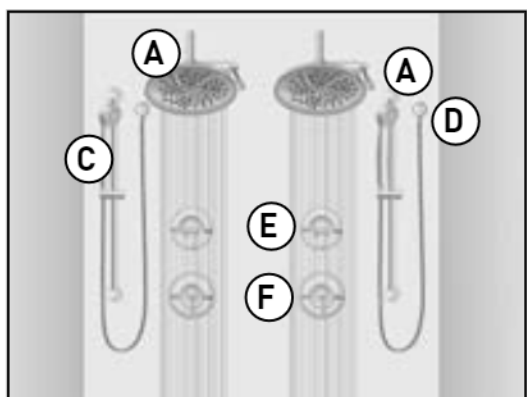



MOENTROL® AND TRANSFER VALVE



SHOWER/SPA CONFIGURATION-OPTION B



	SKU#	TO ORDER...
A. (2) Shower arms & Flanges	S113	See page 346
B. (2) Showerheads	S1311	See page 329
C. (2) Hand Showers	3667EP	See page 338
D. (2) Drop Ells	A725	See page 344
E. (2) Transfer Valves	3372	See page 106
(2) Transfer Valve Trims	TS5205	See page 127
F. (2) Moentrol® Valves	3520	See page 117
(2) Moentrol® Valve Trims	TS3211	See page 130



Moentrol® Transfer Valve Showering Components



Must order Rough-In-Valve and Trim Pack separately.

	MODEL NUMBER	LIST PRICE	FINISH/ CONNECTION	CASE QTY
MOENTROL® VALVE ONLY				
				
	• ports: four	3520	210.05 1/2" CC	6
	• adjustable temperature limit stop: included	3510	210.05 1/2" IPS	6
• includes: volume control				
				

MOENTROL® VALVE ONLY				
				
	• ports: four	3570	232.40 1/2" CC	6
	• adjustable temperature limit stop: included			
• includes: volume control				
• check stops: included				
				

3 INDEPENDENT FUNCTION TRANSFER VALVE ONLY				
				
	• ports: four	3362	215.60 1/2" CC	6
	• type of function: three independent function			
• must be used with: Posi-Temp® or Moentrol® valve				
				

TRANSFER VALVE ONLY				
				
	• type of function: two independent one shared	3372	188.30 1/2" CC	12
	• must be used with: Posi-Temp® or Moentrol® valve			
				

TRANSFER VALVE ONLY				
				
	• type of function: two discrete	3375	188.30 1/2" CC	12
	• must be used with: Posi-Temp® or Moentrol® valve			
				

Valve	Flow Rate through shower port (GPM) @ 20 PSI	Flow Rate through shower port (GPM) @ 40 PSI	Flow Rate through shower port (GPM) @ 60 PSI	Used with 2- or 3-Function Transfer	Maximum Components
Moentrol® 3520, 3510, 3570	3.5	5.0	6.3	Yes	Showerhead, Handshower or Showerhead, 2 Bodysprays

Use 3372 or 3375 in conjunction with either a Posi-Temp® or Moentrol® shower valve.

NOTES

 Moen® M•FACT® Common Valve System

CUSTOM SHOWERING

Moentrol® Transfer Valve Showering Components

Must order Rough-In-Valve and Trim Pack separately.

All Brushed Nickel, Polished Nickel, Polished Brass and Brushed Gold faucet components feature the Lifeshine® Non-Tarnish Finish.

		MODEL NUMBER	LIST PRICE	FINISH/ CONNECTION	CASE QTY
	ANNEX™ SHOWER RAIL <ul style="list-style-type: none"> • connection size: 1/2" • connection type: IPS • showerhead type: showerhead sold separately • handshower type: handshower sold separately • type of function: two independent functions • hose length: 59" 	TS3661NH	561.25	Chrome	3
		TS3661NHBN	833.20	Brushed Nickel	3
		TS3661NHBL	833.20	Matte Black	3
		TS3661NHORB	833.20	Oil Rubbed Bronze	3
	WEYMOUTH® 3 INDEPENDENT FUNCTION TRANSFER VALVE ONLY <ul style="list-style-type: none"> • use with 3362 transfer valve • valve sold separately 	TS32206	266.80	Chrome	12
		TS32206BN	383.55	Brushed Nickel	12
		TS32206NL	383.55	Polished Nickel	12
		TS32206ORB	383.55	Oil Rubbed Bronze	12
		NEW! TS32206BG	383.55	Brushed Gold	12
		NEW! TS32206BL*	383.55	Matte Black	-
	ARRIS® 3 INDEPENDENT FUNCTION TRANSFER VALVE ONLY <ul style="list-style-type: none"> • use with 3362 transfer valve • valve sold separately 	TS23006	266.80	Chrome	12
		TS23006BN	383.55	Brushed Nickel	12
	90 DEGREE™ 3 INDEPENDENT FUNCTION TRANSFER VALVE ONLY <ul style="list-style-type: none"> • use with 3362 transfer valve • valve sold separately 	TS4173	153.20	Chrome	12
		TS4173BN	231.85	Brushed Nickel	12
	VIA® 3 INDEPENDENT FUNCTION TRANSFER VALVE ONLY <ul style="list-style-type: none"> • use with 3362 transfer valve • valve sold separately 	TS2172	153.20	Chrome	12
	WYNFORD® 3 INDEPENDENT FUNCTION TRANSFER VALVE ONLY <ul style="list-style-type: none"> • use with 3362 transfer valve • valve sold separately 	T4512	134.25	Chrome	12
		T4512BN	205.25	Brushed Nickel	12
		T4512NL	205.25	Polished Nickel	12
		T4512ORB	205.25	Oil Rubbed Bronze	12
	ALIGN® 3 INDEPENDENT FUNCTION TRANSFER VALVE ONLY <ul style="list-style-type: none"> • use with 3362 transfer valve • valve sold separately 	T4192	136.85	Chrome	12
		T4192BN	205.25	Brushed Nickel	12
		T4192BL	205.25	Matte Black	12
		NEW! T4192BG	205.25	Brushed Gold	12
		NOTES			

 Moen® **M•PACT®** Common Valve System

*Ships Q2

Moentrol® Transfer Valve Showering Components

Must order Rough-In-Valve and Trim Pack separately.

All Brushed Nickel, Polished Nickel, Polished Brass and Brushed Gold faucet components feature the Lifeshine® Non-Tarnish Finish.

		MODEL NUMBER	LIST PRICE	FINISH/ CONNECTION	CASE QTY
VOSS™ 3 INDEPENDENT FUNCTION TRANSFER VALVE ONLY					
	<ul style="list-style-type: none"> use with 3362 transfer valve valve sold separately  	T4612	134.25	Chrome	12
		T4612BN	205.25	Brushed Nickel	12
		T4612ORB	205.25	Oil Rubbed Bronze	12
		T4612BG	205.25	Brushed Gold	12
		T4612NL*	205.25	Polished Nickel	-
RIZON® 3 INDEPENDENT FUNCTION TRANSFER VALVE ONLY					
	<ul style="list-style-type: none"> use with 3362 transfer valve valve sold separately  	T2082	130.55	Chrome	12
		T2082BN	197.75	Brushed Nickel	12
		T2082BL*	197.75	Matte Black	-
WEYMOUTH® 2/3 FUNCTION TRANSFER VALVE ONLY					
	<ul style="list-style-type: none"> use with 3372 or 3375 transfer valve valve: sold separately  	TS32205	261.25	Chrome	6
		TS32205BN	374.50	Brushed Nickel	6
		TS32205BG	374.50	Brushed Gold	12
		TS32205NL	374.50	Polished Nickel	6
		TS32205ORB	374.50	Oil Rubbed Bronze	6
TS32205BL*	374.50	Matte Black	-		
ARRIS® 2/3 FUNCTION TRANSFER VALVE ONLY					
	<ul style="list-style-type: none"> use with 3372 or 3375 transfer valve valve: sold separately  	TS23005	261.25	Chrome	6
		TS23005BN	374.50	Brushed Nickel	6
		TS23005BL*	374.50	Matte Black	-
90 DEGREE™ 2/3 FUNCTION TRANSFER VALVE ONLY					
	<ul style="list-style-type: none"> use with 3372 or 3375 transfer valve valve: sold separately  	TS4172	147.60	Chrome	6
		TS4172BN	222.70	Brushed Nickel	6
VIA® 2/3 FUNCTION TRANSFER VALVE ONLY					
	<ul style="list-style-type: none"> use with 3372 or 3375 transfer valve valve sold separately  	TS2171	147.60	Chrome	12
DOUX™ 2/3 FUNCTION TRANSFER VALVE ONLY					
	<ul style="list-style-type: none"> use with 3372 or 3375 transfer valve valve: sold separately  	TS9204	177.10	Chrome	12
		TS9204BN	278.40	Brushed Nickel	12
		TS9204BL	278.40	Matte Black	12

CUSTOM SHOWERING

HOW TO ORDER MOENTROL SHOWER WITH 2/3 FUNCTION TRANSFER VALVE

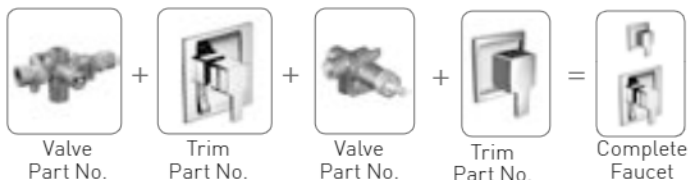

NOTES

 Moen® M•PACT® Common Valve System

*Ships Q2

Moentrol® Transfer Valve Showering Components

Must order Rough-In-Valve and Trim Pack separately.

All Brushed Nickel, Polished Nickel, Polished Brass and Brushed Gold faucet components feature the Lifeshine® Non-Tarnish Finish.

		MODEL NUMBER	LIST PRICE	FINISH/ CONNECTION	CASE QTY
ROTHBURY™ 2/3 FUNCTION TRANSFER VALVE ONLY					
 <ul style="list-style-type: none"> • use with 3372 or 3375 transfer valve • valve sold separately  		TS5205	147.60	Chrome	6
		TS5205BN	222.70	Brushed Nickel	6
		TS5205ORB	222.70	Oil Rubbed Bronze	6
WYNFORD™ 2/3 FUNCTION TRANSFER VALVE ONLY					
 <ul style="list-style-type: none"> • use with 3372 or 3375 transfer valve • valve sold separately  		T4511	128.90	Chrome	12
		T4511BN	196.20	Brushed Nickel	12
		T4511NL	196.20	Polished Nickel	12
		T4511ORB	196.20	Oil Rubbed Bronze	12
ALIGN® 2/3 FUNCTION TRANSFER VALVE ONLY					
 <ul style="list-style-type: none"> • use with 3372 or 3375 transfer valve • valve sold separately  		T4191	128.90	Chrome	12
		T4191BN	196.20	Brushed Nickel	12
		T4191BL	196.20	Matte Black	12
		T4191BG	196.20	Brushed Gold	12
VOSS™ 2/3 FUNCTION TRANSFER VALVE TRIM					
 <ul style="list-style-type: none"> • use with 3372 or 3375 transfer valve • valve sold separately  		T4611	128.90	Chrome	12
		T4611BN	196.20	Brushed Nickel	12
		T4611ORB	196.20	Oil Rubbed Bronze	12
		T4611BG	196.20	Brushed Gold	12
		T4611NL*	196.20	Polished Nickel	-
BELFIELD™ 2/3 FUNCTION TRANSFER VALVE ONLY					
 <ul style="list-style-type: none"> • use with 3372 or 3375 transfer valve • valve sold separately  		T4301	128.90	Chrome	12
		T4301BN	196.20	Brushed Nickel	12
		T4301ORB	196.20	Oil Rubbed Bronze	12
		T4301NL*	196.20	Polished Nickel	-
KINGSLEY® 2/3 FUNCTION TRANSFER VALVE ONLY					
 <ul style="list-style-type: none"> • use with 3372 or 3375 transfer valve • valve sold separately  		T4311	128.90	Chrome	6
		T4311BN	196.20	Brushed Nickel	6
		T4311ORB	196.20	Oil Rubbed Bronze	6
EVA® 2/3 FUNCTION TRANSFER VALVE ONLY					
 <ul style="list-style-type: none"> • use with 3372 or 3375 transfer valve • valve sold separately  		T2011	122.55	Chrome	12
		T2011BN	185.65	Brushed Nickel	12
		T2011ORB	185.65	Oil Rubbed Bronze	12

HOW TO ORDER MOENTROL SHOWER WITH 2/3 FUNCTION TRANSFER VALVE

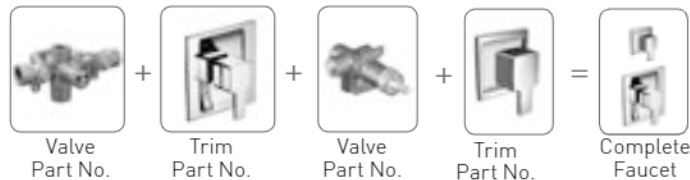

NOTES

 Moen® **M•PACT**® Common Valve System
*Ships Q2

Moentrol® Transfer Valve Showering Components

Must order Rough-In-Valve and Trim Pack separately.

All Brushed Nickel, Polished Nickel, Polished Brass and Brushed Gold faucet components feature the Lifeshine® Non-Tarnish Finish.

		MODEL NUMBER	LIST PRICE	FINISH/ CONNECTION	CASE QTY
BRANTFORD® 2/3 FUNCTION TRANSFER VALVE ONLY					
 <ul style="list-style-type: none"> • use with 3372 or 3375 transfer valve • valve sold separately  		T2021	122.55	Chrome	12
		T2021BN	185.65	Brushed Nickel	12
		T2021ORB	185.65	Oil Rubbed Bronze	12
MOEN® TRANSFER VALVE TRIM					
 <ul style="list-style-type: none"> • use with 3372 or 3375 transfer valve • valve sold separately  		T4171	126.10	Chrome	6
		T4171BN	189.75	Brushed Nickel	6
		T4171ORB	189.75	Oil Rubbed Bronze	6
WEYMOUTH® MOENTROL® VALVE ONLY					
 <ul style="list-style-type: none"> • valve sold separately  		TS33101	327.75	Chrome	3
		TS33101BN	491.55	Brushed Nickel	3
		TS33101NL	491.55	Polished Nickel	3
		TS33101ORB	491.55	Oil Rubbed Bronze	3
		NEW! TS33101BG	491.55	Brushed Gold	3
		NEW! TS33101BL*	491.55	Matte Black	-
ARRIS® MOENTROL® VALVE ONLY					
 <ul style="list-style-type: none"> • valve sold separately  		TS32001	327.75	Chrome	3
		TS32001BN	491.55	Brushed Nickel	3
		NEW! TS32001BL*	491.55	Matte Black	-
DOUX™ MOENTROL® VALVE ONLY					
 <ul style="list-style-type: none"> • valve: sold separately  		TS3201	231.40	Chrome	3
		TS3201BN	464.85	Brushed Nickel	3
		TS3201BL	464.85	Matte Black	3
90 DEGREE™ MOENTROL® VALVE TRIM					
 <ul style="list-style-type: none"> • valve sold separately  		TS3711	191.90	Chrome	3
		TS3711BN	438.20	Brushed Nickel	3

CUSTOM SHOWERING

HOW TO ORDER MOENTROL SHOWER WITH 2/3 FUNCTION TRANSFER VALVE

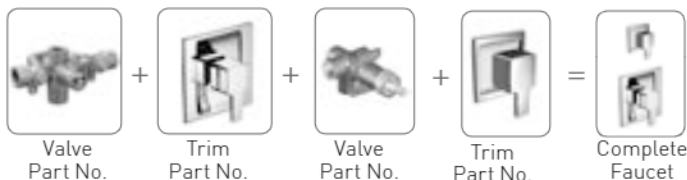

NOTES

 Moen® M•PACT® Common Valve System

*Ships Q2

Moentrol® Transfer Valve Showering Components

Must order Rough-In-Valve and Trim Pack separately.

All Brushed Nickel, Polished Nickel, Polished Brass and Brushed Gold faucet components feature the Lifeshine® Non-Tarnish Finish.

		MODEL NUMBER	LIST PRICE	FINISH/ CONNECTION	CASE QTY
	ROTHBURY™	MOENTROL® VALVE TRIM			
	• valve sold separately	TS3211	191.90	Chrome	3
	 	TS3211BN	438.20	Brushed Nickel	3
		TS3211ORB	438.20	Oil Rubbed Bronze	3
	ICON™	MOENTROL® VALVE TRIM			
	• valve sold separately	TS2154	174.45	Chrome	3
	 	TS2154BN	375.80	Brushed Nickel	3
	WYNFORD™	MOENTROL® VALVE TRIM			
	• valve sold separately	T5501	159.60	Chrome	3
	 	T5501BN	347.05	Brushed Nickel	3
		T5501NL	347.05	Polished Nickel	3
		T5501ORB	347.05	Oil Rubbed Bronze	3
	ALIGN®	MOENTROL® VALVE TRIM			
	• valve sold separately	T3291	159.60	Chrome	3
	 	T3291BN	347.05	Brushed Nickel	3
		NEW! T3291BG	347.05	Brushed Gold	3
	VOSS™	MOENTROL® VALVE TRIM			
	• valve sold separately	T3691	159.60	Chrome	3
	 	T3691BN	347.05	Brushed Nickel	3
		T3691ORB	347.05	Oil Rubbed Bronze	3
		NEW! T3691BG	347.05	Brushed Gold	3
	NEW! T3691NL*	347.05	Polished Nickel	-	
	BELFIELD™	MOENTROL® VALVE ONLY			
	• valve sold separately	T3311	159.60	Chrome	3
	 	T3311BN	347.05	Brushed Nickel	3
		T3311ORB	347.05	Oil Rubbed Bronze	3
		NEW! T3311NL*	347.05	Polished Nickel	-
	KINGSLEY®	MOENTROL® VALVE TRIM			
	• valve sold separately	T3111	159.60	Chrome	3
	 	T3111BN	347.05	Brushed Nickel	3
		T3111ORB	347.05	Oil Rubbed Bronze	3

CUSTOM SHOWERING

HOW TO ORDER MOENTROL SHOWER WITH 2/3 FUNCTION TRANSFER VALVE

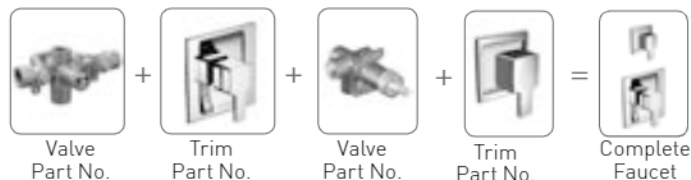

NOTES

 Moen® **M•PACT®** Common Valve System
*Ships Q2

POSI-TEMP® Shower Spa with Annex™ Shower Rail Showering Components

Due to Department of Energy regulations, plumbing manufacturers can no longer sell vertical spas packaged together as a single SKU. Moen has all the components necessary for you to build a custom Spa Shower a la carte. And, we're making it easy for you to pull together the sku numbers you need. Charts of common spa shower configurations are included so that all the components can be ordered. For additional assistance, call your Moen Sales Representative.





WEYMOUTH® Posi-Temp® Shower Spa with Annex™ Shower Rail				
Product	Description	QTY.	Chrome	Chrome List Price
	Weymouth Posi-Temp valve only trim	1	TS3210	284.95
	Posi-Temp valve	1	2520	152.20
	Annex shower rail	1	TS3661NH	561.25
	Showerhead	1	S1311EP	434.65
	Shower arm	1	S113	125.85
	One-function handshower	1	154305	171.80
Total:				\$1,730.70

ARRIS® Posi-Temp® Shower Spa with Annex™ Shower Rail				
Product	Description	QTY.	Chrome	Chrome List Price
	Arris Posi-Temp valve only trim	1	TS22001	284.95
	Posi-Temp valve	1	2520	152.20
	Annex shower rail	1	TS3661NH	561.25
	Showerhead	1	S112EP	404.20
	Shower arm	1	S110	125.85
	One-function handshower	1	155891	88.60
Total:				\$1,617.05

WATERHILL® Posi-Temp® Shower Spa with Annex™ Shower Rail				
Product	Description	QTY.	Chrome	Chrome List Price
	Waterhill Posi-Temp valve only trim	1	TS310	270.75
	Posi-Temp valve	1	2520	152.20
	Annex shower rail	1	TS3661NH	561.25
	Showerhead	1	S112EP	404.20
	Shower arm	1	S113	125.85
	One-function handshower	1	155891	88.60
Total:				\$1,602.85

Posi-Temp® with Annex™ Shower Rail Options

90° Posi-Temp® Shower Spa with Annex™ Shower Rail				
Product	Description	QTY.	Chrome	Chrome List Price
	90° Posi-Temp valve only trim	1	TS2711	172.00
	Posi-Temp valve	1	2520	152.20
	Annex shower rail	1	TS3661NH	561.25
	Showerhead	1	S6340EP	151.15
	One-function handshower	1	176257	105.80
Total:				\$1,142.40

VIA™ Posi-Temp® Shower Spa with Annex™ Shower Rail				
Product	Description	QTY.	Chrome	Chrome List Price
	Via Posi-Temp valve only trim	1	TS8711	172.00
	Posi-Temp valve	1	2520	152.20
	Annex shower rail	1	TS3661NH	561.25
	Showerhead	1	S6365EP	151.15
	One-function handshower	1	155891	88.60
Total:				\$1,125.20

ROTHBURY™ Posi-Temp® Shower Spa with Annex™ Shower Rail				
Product	Description	QTY.	Chrome	Chrome List Price
	Rothbury Posi-Temp valve only trim	1	TS2211	172.00
	Posi-Temp valve	1	2520	152.20
	Annex shower rail	1	TS3661NH	561.25
	Showerhead	1	S6335EP	151.15
	Four-function handshower	1	164927	110.75
Total:				\$1,147.35

ICON™ Posi-Temp® Shower Spa with Annex™ Shower Rail				
Product	Description	QTY.	Chrome	Chrome List Price
	Icon Posi-Temp valve only trim	1	TS2141	155.55
	Posi-Temp valve	1	2520	152.20
	Annex shower rail	1	TS3661NH	561.25
	Showerhead	1	S6312EP	143.80
	One-function handshower	1	155891	88.60
Total:				\$1,101.40

Posi-Temp® with Annex™ Shower Rail Options

WYNFORD® Posi-Temp® Shower Spa with Annex™ Shower Rail				
Product	Description	QTY.	Chrome	Chrome List Price
	Wynford Posi-Temp valve only trim	1	T4501	142.25
	Posi-Temp valve	1	2520	152.20
	Annex shower rail	1	TS3661NH	561.25
	Showerhead	1	S6312EP	143.80
	Four-function handshower	1	164927	110.75
Total:				\$1,110.25

ALIGN® Posi-Temp® Shower Spa with Annex™ Shower Rail				
Product	Description	QTY.	Chrome	Chrome List Price
	Align Posi-Temp valve only trim	1	T2191	96.80
	Posi-Temp valve	1	2520	152.20
	Annex shower rail	1	TS3661NH	561.25
	Showerhead	1	6399EP	93.25
	One-function handshower	1	155891	88.60
Total:				\$992.10

VOSS™ Posi-Temp® Shower Spa with Annex™ Shower Rail				
Product	Description	QTY.	Chrome	Chrome List Price
	Voss Posi-Temp valve only trim	1	T2691	142.25
	Posi-Temp valve	1	2520	152.20
	Annex shower rail	1	TS3661NH	561.25
	Showerhead	1	6325EP	113.70
	Four-function handshower	1	164928	108.70
Total:				\$1,078.10

KINGSLEY® Posi-Temp® Shower Spa with Annex™ Shower Rail				
Product	Description	QTY.	Chrome	Chrome List Price
	Kingsley Posi-Temp valve only trim	1	T2111	142.25
	Posi-Temp valve	1	2520	152.20
	Annex shower rail	1	TS3661NH	561.25
	Showerhead	1	6302EP	113.70
	Four-function handshower	1	164927	110.75
Total:				\$1,080.15

CUSTOM SHOWERING

Posi-Temp® with Annex™ Shower Rail Options

GLYDE™ Posi-Temp® Shower Spa with Annex™ Shower Rail				
Product	Description	QTY.	Chrome	Chrome List Price
	Glyde Posi-Temp valve only trim	1	T2741	80.95
	Posi-Temp valve	1	2520	152.20
	Annex shower rail	1	TS3661NH	561.25
	Showerhead	1	6370EP	70.75
	Four-function handshower	1	164928	108.70
Total: \$973.85				

DARTMOOR™ Posi-Temp® Shower Spa with Annex™ Shower Rail				
Product	Description	QTY.	Chrome	Chrome List Price
	Dartmoor Posi-Temp valve only trim	1	T2181	80.95
	Posi-Temp valve	1	2520	152.20
	Annex shower rail	1	TS3661NH	561.25
	Showerhead	1	6371EP	70.75
	Four-function handshower	1	164927	110.75
Total: \$975.90				

RIZON® Posi-Temp® Shower Spa with Annex™ Shower Rail				
Product	Description	QTY.	Chrome	Chrome List Price
	Rizon Posi-Temp valve only trim	1	T2811	84.20
	Posi-Temp valve	1	2520	152.20
	Annex shower rail	1	TS3661NH	561.25
	Showerhead	1	6322EP	93.25
	One-function handshower	1	155891	88.60
Total: \$979.50				

BRANTFORD® Posi-Temp® Shower Spa with Annex™ Shower Rail				
Product	Description	QTY.	Chrome	Chrome List Price
	Brantford Posi-Temp valve only trim	1	T2151	73.65
	Posi-Temp valve	1	2520	152.20
	Annex shower rail	1	TS3661NH	561.25
	Showerhead	1	6303EP	64.30
	Four-function handshower	1	164927	110.75
Total: \$962.15				

Posi-Temp® with Annex™ Shower Rail Options

EVA® Posi-Temp® Shower Spa with Annex™ Shower Rail				
Product	Description	QTY.	Chrome	Chrome List Price
	Eva Posi-Temp valve only trim	1	T2131	73.65
	Posi-Temp valve	1	2520	152.20
	Annex shower rail	1	TS3661NH	561.25
	Showerhead	1	6303EP	64.30
	Four-function handshower	1	164928	108.70
			Total: \$960.10	

METHOD™ Posi-Temp® Shower Spa with Annex™ Shower Rail				
Product	Description	QTY.	Chrome	Chrome List Price
	Method Posi-Temp valve only trim	1	T2801	73.65
	Posi-Temp valve	1	2520	152.20
	Annex shower rail	1	TS3661NH	561.25
	Showerhead	1	6300EP	18.20
	One-function handshower	1	155891	88.60
			Total: \$893.90	

POSI-TEMP® AND STANDARD Transfer Valve Showering Components

Due to Department of Energy regulations, plumbing manufacturers can no longer sell vertical spas packaged together as a single SKU. Moen has all the components necessary for you to build a custom vertical spa a la carte. And, we're making it easy for you to pull together the sku numbers you need. Follow the charts below to order all the components in the former vertical spa package offered by Moen.





WEYMOUTH® POSI-TEMP® WITH 3-FUNCTION TRANSFER VALVE Vertical Spa Components										
Product	Description	QTY.	Chrome	Chrome List Price	Brushed Nickel	Brushed Nickel List Price	Oil Rubbed Bronze	Oil Rubbed Bronze List Price	Polished Nickel	Polished Nickel List Price
	Weymouth Posi-Temp shower trim	1	TS32102	540.50	TS32102BN	796.45	TS32102ORB	796.45	TS32102NL	796.45
	Posi-Temp valve	1	2520	152.20	2520	152.20	2520	152.20	2520	152.20
	Weymouth 3-function transfer valve trim	1	TS32206	266.80	TS32206BN	383.55	TS32206ORB	383.55	TS32206NL	383.55
	3-Function transfer valve	1	3362	215.60	3362	215.60	3362	215.60	3362	215.60
	Handshower with slide bar	1	S12107EP	420.45	S12107EPBN	808.40	S12107EPORB	808.40	S12107EPNL	808.40
	Drop ell	1	A725	63.00	A725BN	90.20	A725ORB	90.20	A725NL	90.20
	Non-diverting tub spout	1	S12105	136.05	S12105BN	226.35	S12105ORB	226.35	S12105NL	226.35
			Total: \$1,794.60			Total: \$2,672.75			Total: \$2,672.75	

ARRIS™ POSI-TEMP® WITH 3-FUNCTION TRANSFER VALVE Vertical Spa Components										
Product	Description	QTY.	Chrome	Chrome List Price	Brushed Nickel	Brushed Nickel List Price	Matte Black	Matte Black List Price		
	Arris Posi-Temp shower trim	1	TS22002	540.50	TS22002BN	796.45	TS22002BL	796.45		
	Posi-Temp valve	1	2520	152.20	2520	152.20	2520	152.20		
	Arris 3-function transfer valve trim	1	TS23006	266.80	TS23006BN	383.55	TS23006BL	383.55		
	3-Function transfer valve	1	3362	215.60	3362	215.60	3362	215.60		
	Handshower with slide bar	1	3887EP	352.95	3887EPBN	745.45	3887EPBL	745.45		
	Drop ell	1	A725	63.00	A725BN	90.20	A725WR	90.20		
	Non-diverting tub spout	1	S16900	132.30	S16900BN	220.50	S16900BL	220.50		
			Total: \$1,723.35			Total: \$2,603.95			Total: \$2,603.95	

Posi-Temp® Transfer Valve Showering Components

90° POSI-TEMP® WITH 3-FUNCTION TRANSFER VALVE Vertical Spa Components						
Product	Description	QTY.	Chrome	Chrome List Price	Brushed Nickel	Brushed Nickel List Price
	90° Posi-Temp shower trim	1	TS2712	251.80	TS2712BN	430.70
	Posi-Temp valve	1	2520	152.20	2520	152.20
	90° transfer valve trim	1	TS4173	153.20	TS4173BN	231.85
	3-Function transfer valve	1	3362	215.60	3362	215.60
	90° Handshower with slide bar	1	S3879EP	420.45	S3879EPBN	808.40
	Drop ell	1	A721	71.15	A721BN	101.65
	Non-diverting tub spout	1	S3898	109.50	S3898BN	177.65
				Total: \$1,373.90	Total: \$2,118.05	

WYNFORD™ POSI-TEMP® WITH 3-FUNCTION TRANSFER VALVE Vertical Spa Components									
Product	Description	QTY.	Chrome	Chrome List Price	Brushed Nickel	Brushed Nickel List Price	Oil Rubbed Bronze	Oil Rubbed Bronze List Price	Oil Rubbed Bronze List Price
	Wynford Posi-Temp shower trim	1	T4502	208.20	T4502BN	359.50	T4502ORB	359.50	359.50
	Posi-Temp valve	1	2520	152.20	2520	152.20	2520	152.20	152.20
	Transfer valve trim	1	T4512	134.25	T4512BN	205.25	T4512ORB	205.25	205.25
	3-Function transfer valve	1	3362	215.60	3362	215.60	3362	215.60	215.60
	4-Function handheld shower with slide bar	1	3667EP	326.55	3667EPBN	745.45	3667EPORB	745.45	745.45
	Drop ell	1	A725	63.00	A725BN	90.20	A725ORB	90.20	90.20
	Non-diverting tub spout	1	195386	93.90	195386BN	135.90	195386ORB	135.90	135.90
				Total: \$1,193.70	Total: \$1,904.10		Total: \$1,904.10		

VOSS™ POSI-TEMP® WITH 3-FUNCTION TRANSFER VALVE Vertical Spa Components									
Product	Description	QTY.	Chrome	Chrome List Price	Brushed Nickel	Brushed Nickel List Price	Oil Rubbed Bronze	Oil Rubbed Bronze List Price	Oil Rubbed Bronze List Price
	Voss Posi-Temp shower trim	1	T2692	208.20	T2692BN	359.50	T2692ORB	359.50	359.50
	Posi-Temp valve	1	2520	152.20	2520	152.20	2520	152.20	152.20
	Voss transfer valve trim	1	T4612	134.25	T4612BN	205.25	T4612ORB	205.25	205.25
	3-Function transfer valve	1	3362	215.60	3362	215.60	3362	215.60	215.60
	4-Function handheld shower with slide bar	1	3667EP	326.55	3667EPBN	745.45	3667EPORB	745.45	745.45
	Drop ell	1	A725	63.00	A725BN	90.20	A725ORB	90.20	90.20
	Non-diverting tub spout	1	191956	95.10	191956BN	136.80	191956ORB	136.80	136.80
				Total: \$1,194.90	Total: \$1,905.00		Total: \$1,905.00		

CUSTOM SHOWERING

Posi-Temp® Transfer Valve Showering Components

ALIGN® POSI-TEMP® WITH 3-FUNCTION TRANSFER VALVE Vertical Spa Components								
Product	Description	QTY.	Chrome	Chrome List Price	Brushed Nickel	Brushed Nickel List Price	Matte Black	Matte Black List Price
	Align Posi-Temp shower trim	1	T2192	163.40	T2192BN	319.95	T2192BL	319.95
	Posi-Temp valve	1	2520	152.20	2520	152.20	2520	152.20
	Transfer valve trim	1	T4192	136.85	T4192BN	205.25	T4192BL	205.25
	3-function transfer valve	1	3362	215.60	3362	215.60	3362	215.60
	Handheld shower with slide bar	1	3887EP	352.95	3887EPBN	745.45	3887EPBL	745.45
	Drop ell	1	A725	63.00	A725BN	90.20	A725WR	90.20
	Non-diverting tub spout	1	S16900	132.30	S16900BN	220.50	S16900BL	220.50
				Total: \$1,216.30	Total: \$1,949.15		Total: \$1,949.15	

RIZON™ POSI-TEMP® WITH 3-FUNCTION TRANSFER VALVE Vertical Spa Components						
Product	Description	QTY.	Chrome	Chrome List Price	Brushed Nickel	Brushed Nickel List Price
	Rizon Posi-Temp shower trim	1	T2812	127.10	T2812BN	263.55
	Posi-Temp valve	1	2520	152.20	2520	152.20
	Transfer valve trim	1	T2082	130.55	T2082BN	197.75
	3-Function transfer valve	1	3362	215.60	3362	215.60
	4-Function handheld shower with slide bar	1	3667EP	326.55	3667EPBN	745.45
	Drop ell	1	A725	63.00	A725BN	90.20
	Non-diverting tub spout	1	3829	58.85	3829BN	142.20
				Total: \$1,073.85	Total: \$1,806.95	

Posi-Temp® Transfer Valve Showering Components

Use the three-function transfer valve with a Moentrol® or Posi-Temp® mixing valve to customize your shower by including hand showers, showerheads, tub spouts, or body sprays in addition to your tub/shower combo.

Now available in eight matching trim suite styles, providing a matching look throughout the bathroom..

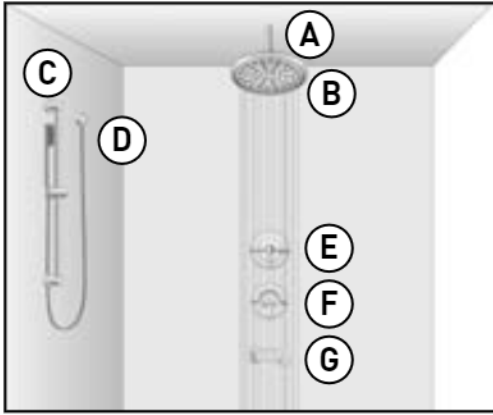

POSI-TEMP® AND TRANSFER VALVE

CONFIGURATION-OPTION A

	SKU#	TO ORDER...
A. (1) Shower arm	226651	See page 346
A. (1) Flange	AT2199	See page 347
B. (1) Showerhead	S6310	See page 331
C. (1) Hand Shower	3887EP	See page 339
D. (1) Drop Ell	A725	See page 344
E. (1) Transfer Valve (behind wall not shown)	3362	See page 106
E. (1) Transfer Valve Trim	T4192	See page 165
F. (1) Posi-Temp® Valve (behind wall not shown)	2520	See page 100
F. (1) Posi-Temp® Valve Trim	T2191	See page 171
G. (1) Non-Diverting Tub Spout	3892	See page 354

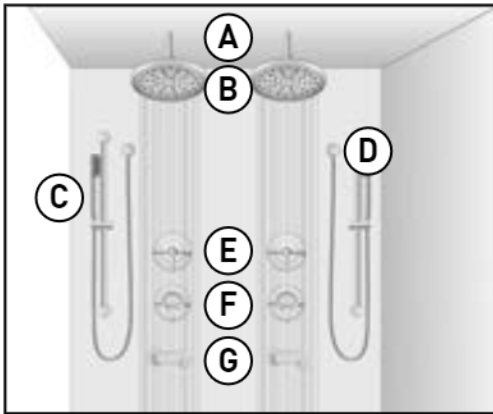

POSI-TEMP® AND TRANSFER VALVE

CONFIGURATION-OPTION B

	SKU#	TO ORDER...
A. (2) Shower arms	226651	See page 346
A. (2) Flanges	AT2199	See page 347
B. (2) Showerheads	S6310	See page 331
C. (2) Hand Showers	3887EP	See page 339
D. (2) Drop Ells	A725	See page 344
E. (2) Transfer Valves (behind wall not shown)	3362	See page 106
E. (2) Transfer Valve Trims	T4192	See page 165
F. (2) Posi-Temp® Valves (behind wall not shown)	2520	See page 100
F. (2) Posi-Temp® Valve Trims	T2191	See page 171
G. (2) Non-Diverting Tub Spouts	3892	See page 354

POSI-TEMP® AND STANDARD Transfer Valve Showering Components

Due to Department of Energy regulations, plumbing manufacturers can no longer sell vertical spas packaged together as a single SKU. Moen has all the components necessary for you to build a custom vertical spa a la carte. And, we're making it easy for you to pull together the sku numbers you need. Follow the charts below to order all the components in the former vertical spa package offered by Moen.



WEYMOUTH® POSI-TEMP® WITH 2/3 FUNCTION TRANSFER VALVE Vertical Spa Components										
Product	Description	QTY.	Chrome	Chrome List Price	Brushed Nickel	Brushed Nickel List Price	Oil Rubbed Bronze	Oil Rubbed Bronze List Price	Polished Nickel	Polished Nickel List Price
	Weymouth Posi-Temp shower trim	1	TS32102	540.50	TS32102BN	796.45	TS32102ORB	796.45	TS32102NL	796.45
	Posi-Temp valve	1	2520	152.20	2520	152.20	2520	152.20	2520	152.20
	Weymouth transfer valve trim	1	TS32205	261.25	TS32205BN	374.50	TS32205ORB	374.50	TS32205NL	374.50
	2/3-Function transfer valve	1	3372*	188.30	3372*	188.30	3372*	188.30	3372*	188.30
	Handshower with slide bar	1	S12107EP	420.45	S12107EPBN	808.40	S12107EPORB	808.40	S12107EPNL	808.40
	Drop ell	1	A725	63.00	A725BN	90.20	A725ORB	90.20	A725NL	90.20
			Total: \$1,625.70		Total: \$2,410.05		Total: \$2,410.05		Total: \$2,410.05	

*For 2 discrete functions, use 3375 transfer valve.

CUSTOM SHOWERING

ARRIS™ POSI-TEMP® WITH 2/3 FUNCTION TRANSFER VALVE Vertical Spa Components										
Product	Description	QTY.	Chrome	Chrome List Price	Brushed Nickel	Brushed Nickel List Price	Matte Black	Matte Black List Price	Matte Black	Matte Black List Price
	Arris Posi-Temp shower trim	1	TS22002	540.50	TS22002BN	796.45	TS22002BL	796.45	TS22002BL	796.45
	Posi-Temp valve	1	2520	152.20	2520	152.20	2520	152.20	2520	152.20
	Arris transfer valve trim	1	TS23005	261.25	TS23005BN	374.50	TS23005BL	374.50	TS23005BL	374.50
	2/3-Function transfer valve	1	3372*	188.30	3372*	188.30	3372*	188.30	3372*	188.30
	Handshower with slide bar	1	3887EP	352.95	3887EPBN	745.45	3887EPBL	745.45	3887EPBL	745.45
	Drop ell	1	A725	63.00	A725BN	90.20	A725WR	90.20	A725WR	90.20
			Total: \$1,558.20		Total: \$2,347.10		Total: \$2,347.10			

*For 2 discrete functions, use 3375 transfer valve.

Posi-Temp® Transfer Valve Showering Components

WATERHILL® POSI-TEMP® WITH 2/3 FUNCTION TRANSFER VALVE Vertical Spa Components								
Product	Description	QTY.	Chrome	Chrome List Price	Brushed Nickel	Brushed Nickel List Price	Oil Rubbed Bronze	Oil Rubbed Bronze List Price
	Waterhill Posi-Temp shower trim	1	TS312	485.15	TS312BN	715.60	TS312ORB	715.60
	Posi-Temp valve	1	2520	152.20	2520	152.20	2520	152.20
	Waterhill transfer valve trim	1	TS325	236.85	TS325BN	348.55	TS325ORB	348.55
	2/3-Function transfer valve	1	3372*	188.30	3372*	188.30	3372*	188.30
	Handshower with slide bar	1	3861EP	364.55	3861EPBN	648.60	3861EPORB	648.60
	Drop ell	1	A725	63.00	A725BN	90.20	A725ORB	90.20
				Total: \$1,490.05	Total: \$2,143.45		Total: \$2,143.45	

*For 2 discrete functions, use 3375 transfer valve.

90°™ POSI-TEMP® WITH 2/3 FUNCTION TRANSFER VALVE Vertical Spa Components						
Product	Description	QTY.	Chrome	Chrome List Price	Brushed Nickel	Brushed Nickel List Price
	90° Posi-Temp shower trim	1	TS2712	251.80	TS2712BN	430.70
	Posi-Temp valve	1	2520	152.20	2520	152.20
	90° transfer valve trim	1	TS4172	147.60	TS4172BN	222.70
	2/3-Function transfer valve	1	3372*	188.30	3372*	188.30
	90° Handshower with slide bar	1	S3879EP	420.45	S3879EPBN	808.40
	Drop ell	1	A721	71.15	A721BN	101.65
				Total: \$1,231.50	Total: \$1,903.95	

*For 2 discrete functions, use 3375 transfer valve.

ROTHBURY™ POSI-TEMP® WITH 2/3 FUNCTION TRANSFER VALVE Vertical Spa Components								
Product	Description	QTY.	Chrome	Chrome List Price	Brushed Nickel	Brushed Nickel List Price	Oil Rubbed Bronze	Oil Rubbed Bronze List Price
	Rothbury Posi-Temp shower trim	1	TS2212	251.80	TS2212BN	430.70	TS2212ORB	430.70
	Posi-Temp valve	1	2520	152.20	2520	152.20	2520	152.20
	Rothbury transfer valve trim	1	TS5205	147.60	TS5205BN	222.70	TS5205ORB	222.70
	2/3-Function transfer valve	1	3372*	188.30	3372*	188.30	3372*	188.30
	Handshower with slide bar	1	3869EP	426.80	3869EPBN	745.45	3869EPORB	745.45
	Drop ell	1	A725	63.00	A725BN	90.20	A725ORB	90.20
				Total: \$1,229.70	Total: \$1,829.55		Total: \$1,829.55	

*For 2 discrete functions, use 3375 transfer valve.

CUSTOM SHOWERING

Posi-Temp® Transfer Valve Showering Components

WYNFORD™ POSI-TEMP® WITH 2/3 FUNCTION TRANSFER VALVE Vertical Spa Components								
Product	Description	QTY.	Chrome	Chrome List Price	Brushed Nickel	Brushed Nickel List Price	Oil Rubbed Bronze	Oil Rubbed Bronze List Price
	Wynford Posi-Temp shower trim	1	T4502	208.20	T4502BN	359.50	T4502ORB	359.50
	Posi-Temp valve	1	2520	152.20	2520	152.20	2520	152.20
	Transfer valve trim	1	T4511	128.90	T4511BN	196.20	T4511ORB	196.20
	2/3-Function transfer valve	1	3372*	188.30	3372*	188.30	3372*	188.30
	4-Function handheld shower with slide bar	1	3667EP	326.55	3667EPBN	745.45	3667EPORB	745.45
	Drop ell	1	A725	63.00	A725BN	90.20	A725ORB	90.20
				Total: \$1,067.15	Total: \$1,731.85		Total: \$1,731.85	

*For 2 discrete functions, use 3375 transfer valve.

VOSS™ POSI-TEMP® WITH 2/3 FUNCTION TRANSFER VALVE Vertical Spa Components								
Product	Description	QTY.	Chrome	Chrome List Price	Brushed Nickel	Brushed Nickel List Price	Oil Rubbed Bronze	Oil Rubbed Bronze List Price
	Voss Posi-Temp shower trim	1	T2692	208.20	T2692BN	359.50	T2692ORB	359.50
	Posi-Temp valve	1	2520	152.20	2520	152.20	2520	152.20
	Voss transfer valve trim	1	T4611	128.90	T4611BN	196.20	T4611ORB	196.20
	2/3-Function transfer valve	1	3372*	188.30	3372*	188.30	3372*	188.30
	4-Function handheld shower with slide bar	1	3667EP	326.55	3667EPBN	745.45	3667EPORB	745.45
	Drop ell	1	A725	63.00	A725BN	90.20	A725ORB	90.20
				Total: \$1,067.15	Total: \$1,731.85		Total: \$1,731.85	

*For 2 discrete functions, use 3375 transfer valve.

ALIGN® POSI-TEMP® WITH 2/3 FUNCTION TRANSFER VALVE Vertical Spa Components								
Product	Description	QTY.	Chrome	Chrome List Price	Brushed Nickel	Brushed Nickel List Price	Matte Black	Matte Black List Price
	Align Posi-Temp shower trim	1	T2192	163.40	T2192BN	319.95	T2192BL	319.95
	Posi-Temp valve	1	2520	152.20	2520	152.20	2520	152.20
	Transfer valve trim	1	T4191	128.90	T4191BN	196.20	T4191BL	196.20
	2/3-Function transfer valve	1	3372*	188.30	3372*	188.30	3372*	188.30
	Handheld shower with slide bar	1	3887EP	352.95	3887EPBN	745.45	3887EPBL	745.45
	Drop ell	1	A725	63.00	A725BN	90.20	A725WR	90.20
				Total: \$1,048.75	Total: \$1,692.30		Total: \$1,692.30	

*For 2 discrete functions, use 3375 transfer valve.

BRANTFORD™ POSI-TEMP® WITH 2/3 FUNCTION TRANSFER VALVE Vertical Spa Components								
Product	Description	QTY.	Chrome	Chrome List Price	Brushed Nickel	Brushed Nickel List Price	Oil Rubbed Bronze	Oil Rubbed Bronze List Price
	Brantford Posi-Temp shower trim	1	T2152	93.80	T2152BN	219.10	T2152ORB	219.10
	Posi-Temp valve	1	2520	152.20	2520	152.20	2520	152.20
	Transfer valve trim	1	T2021	122.55	T2021BN	185.65	T2021ORB	185.65
	2/3-Function transfer valve	1	3372*	188.30	3372*	188.30	3372*	188.30
	4-Function handheld shower with slide bar	1	3667EP	326.55	3667EPBN	745.45	3667EPORB	745.45
	Drop ell	1	A725	63.00	A725BN	90.20	A725ORB	90.20
				Total: \$946.40	Total: \$1,580.90		Total: \$1,580.90	

*For 2 discrete functions, use 3375 transfer valve.

Posi-Temp® Transfer Valve Showering Components

Use the three-function or two-function transfer valve with a Moentrol® or Posi-Temp® mixing valve to customize your shower by including hand showers, showerheads, or body sprays in addition to your tub/shower combo.

Now available in six matching trim suite styles or the neutral style that works well with any trim suite of your choice to add flexibility.

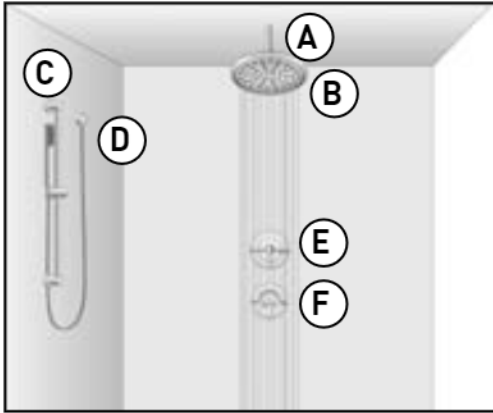

POSI-TEMP® AND TRANSFER VALVE

CONFIGURATION-OPTION A

	SKU#	TO ORDER...
A. (1) Shower arm	226651	See page 346
A. (1) Flange	AT2199	See page 347
B. (1) Showerhead	S6310	See page 331
C. (1) Hand Shower	3887EP	See page 339
D. (1) Drop Ell	A725	See page 344
E. (1) Transfer Valve (behind wall not shown)	3375	See page 106
E. (1) Transfer Valve Trim	TS5205	See page 127
F. (1) Posi-Temp® Valve (behind wall not shown)	2520	See page 100
F. (1) Posi-Temp® Valve Trim	TS2211	See page 133

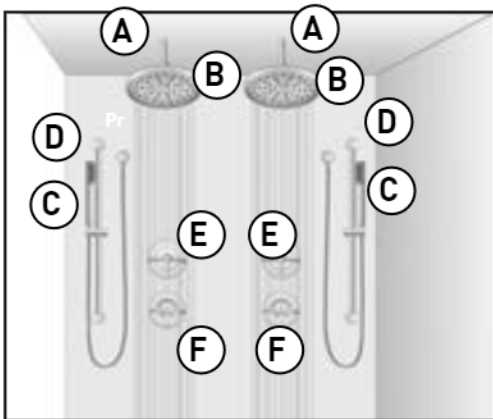

POSI-TEMP® AND TRANSFER VALVE

CONFIGURATION-OPTION B

	SKU#	TO ORDER...
A. (2) Shower arms	226651	See page 346
A. (2) Flanges	AT2199	See page 347
B. (2) Showerheads	S6310	See page 331
C. (2) Hand Showers	3887EP	See page 339
D. (2) Drop Ells	A725	See page 344
E. (2) Transfer Valves (behind wall not shown)	3375	See page 106
E. (2) Transfer Valve Trims	TS5205	See page 127
F. (2) Posi-Temp® Valves (behind wall not shown)	2520	See page 100
F. (2) Posi-Temp® Valve Trims	TS2211	See page 133

Posi-Temp® Transfer Valve Showering Components

Must order Rough-In-Valve and Trim Pack separately.

All Brushed Nickel, Polished Nickel and Polished Brass faucet components feature the Lifeshine® Non-Tarnish Finish.

	MODEL NUMBER	LIST PRICE	FINISH/ CONNECTION	CASE QTY
--	--------------	------------	--------------------	----------

POSI-TEMP® VALVE ONLY



- ports: four
- adjustable temperature limit stop: included



2520

152.20 1/2" CC

6

POSI-TEMP® VALVE ONLY



- ports: four
- adjustable temperature limit stop: included
- quarter turn stops: included



2570

194.75 1/2" CC

6

TRANSFER VALVE ONLY



- type of function: two independent one shared
- must be used with: Posi-Temp® or Moentrol® valve



3372

188.30 1/2" CC

12

TRANSFER VALVE ONLY



- type of function: two discrete
- must be used with: Posi-Temp® or Moentrol® valve



3375

188.30 1/2" CC

12

Valve	Flow Rate through shower port (GPM) @ 20 PSI	Flow Rate through shower port (GPM) @ 40 PSI	Flow Rate through shower port (GPM) @ 60 PSI	Used with 2- or 3-Function Transfer	Maximum Components
Posi-Temp® 3520, 3510, 3570	2.1	3.2	4.0	Yes	Showerhead, Handshower

Use 3372 or 3375 in conjunction with either a Posi-Temp® or Moentrol® shower valve.

HOW TO ORDER POSI-TEMP SHOWER WITH 2/3 FUNCTION TRANSFER VALVE

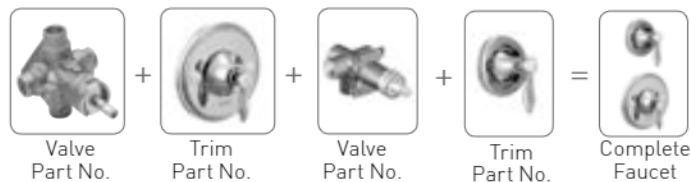

NOTES

Moen® M-FACT® Common Valve System

Posi-Temp® Transfer Valve Showering Components

Must order Rough-In-Valve and Trim Pack separately.

All Brushed Nickel, Polished Nickel, Polished Brass and Brushed Gold faucet components feature the Lifeshine® Non-Tarnish Finish.

		MODEL NUMBER	LIST PRICE	FINISH/ CONNECTION	CASE QTY
WEYMOUTH®  <ul style="list-style-type: none"> • use with 3372 or 3375 transfer valve • valve: sold separately 	2/3 FUNCTION TRANSFER VALVE TRIM				
		TS32205	261.25	Chrome	6
		TS32205BN	374.50	Brushed Nickel	6
		TS32205NL	374.50	Polished Nickel	6
		TS32205ORB	374.50	Oil Rubbed Bronze	6
		NEW! TS32205BG	374.50	Brushed Gold	12
	NEW! TS32205BL*	374.50	Matte Black	-	
ARRIS®  <ul style="list-style-type: none"> • use with 3372 or 3375 transfer valve • valve: sold separately 	2/3 FUNCTION TRANSFER VALVE TRIM				
		TS23005	261.25	Chrome	6
		TS23005BN	374.50	Brushed Nickel	6
		NEW! TS23005BL*	374.50	Matte Black	-
WATERHILL®  <ul style="list-style-type: none"> • use with 3372 or 3375 transfer valve • valve: sold separately 	2/3 FUNCTION TRANSFER VALVE TRIM				
		TS325	236.85	Chrome	6
		TS325BN	348.55	Brushed Nickel	6
		TS325ORB	348.55	Oil Rubbed Bronze	6
90 DEGREE™  <ul style="list-style-type: none"> • use with 3372 or 3375 transfer valve • valve: sold separately 	2/3 FUNCTION TRANSFER VALVE TRIM				
		TS4172	147.60	Chrome	6
		TS4172BN	222.70	Brushed Nickel	6
DOUX™  <ul style="list-style-type: none"> • use with 3372 or 3375 transfer valve • valve: sold separately 	2/3 FUNCTION TRANSFER VALVE TRIM ONLY				
	NEW!	TS9204	177.10	Chrome	12
		TS9204BN	278.40	Brushed Nickel	12
		TS9204BL	278.40	Matte Black	12
ROTHBURY®  <ul style="list-style-type: none"> • use with 3372 or 3375 transfer valve • valve: sold separately 	2/3 FUNCTION TRANSFER VALVE TRIM				
		TS5205	147.60	Chrome	6
		TS5205BN	222.70	Brushed Nickel	6
		TS5205ORB	222.70	Oil Rubbed Bronze	6

CUSTOM SHOWERING

Use 3372 or 3375 in conjunction with either a Posi-Temp® or Moentrol® shower valve.

HOW TO ORDER POSI-TEMP SHOWER WITH 2/3 FUNCTION TRANSFER VALVE

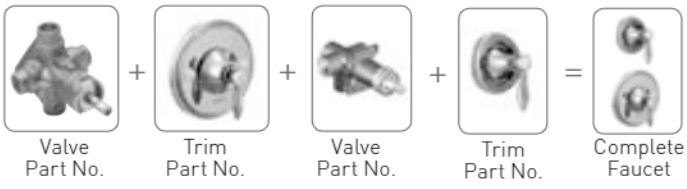

NOTES

 Moen® M•PACT® Common Valve System

*Ships Q2

Posi-Temp® Transfer Valve Showering Components

Must order Rough-In-Valve and Trim Pack separately.

All Brushed Nickel, Polished Nickel, Polished Brass and Brushed Gold faucet components feature the Lifeshine® Non-Tarnish Finish.

		MODEL NUMBER	LIST PRICE	FINISH/ CONNECTION	CASE QTY
WYNFORD™ 2/3 FUNCTION TRANSFER VALVE TRIM					
 <ul style="list-style-type: none"> • use with 3372 or 3375 transfer valve • valve: sold separately 		T4511	128.90	Chrome	12
		T4511BN	196.20	Brushed Nickel	12
		T4511NL	196.20	Polished Nickel	12
		T4511ORB	196.20	Oil Rubbed Bronze	12
VOSS™ 2/3 FUNCTION TRANSFER VALVE TRIM					
 <ul style="list-style-type: none"> • use with 3372 or 3375 transfer valve • valve: sold separately 		T4611	128.90	Chrome	12
		T4611BN	196.20	Brushed Nickel	12
		T4611ORB	196.20	Oil Rubbed Bronze	12
		T4611BG	196.20	Brushed Gold	12
		T4611NL*	196.20	Polished Nickel	-
BELFIELD™ 2/3 FUNCTION TRANSFER VALVE TRIM ONLY					
 <ul style="list-style-type: none"> • use with 3372 or 3375 transfer valve • valve: sold separately 		T4301	128.90	Chrome	12
		T4301BN	196.20	Brushed Nickel	12
		T4301NL*	196.20	Polished Nickel	-
		T4301ORB	196.20	Oil Rubbed Bronze	12
KINGSLEY® 2/3 FUNCTION TRANSFER VALVE TRIM					
 <ul style="list-style-type: none"> • use with 3372 or 3375 transfer valve • valve: sold separately 		T4311	128.90	Chrome	6
		T4311BN	196.20	Brushed Nickel	6
		T4311ORB	196.20	Oil Rubbed Bronze	6
RIZON® 2/3 FUNCTION TRANSFER VALVE					
 <ul style="list-style-type: none"> • use with 3372 or 3375 transfer valve • valve sold separately 		T2081	125.25	Chrome	12
		T2081BN	189.70	Brushed Nickel	12
		T2081BL*	189.70	Matte Black	-
BRANTFORD® 2/3 FUNCTION TRANSFER VALVE					
 <ul style="list-style-type: none"> • use with 3372 or 3375 transfer valve • valve sold separately 		T2021	122.55	Chrome	12
		T2021BN	185.65	Brushed Nickel	12
		T2021ORB	185.65	Oil Rubbed Bronze	12

Use 3372 or 3375 in conjunction with either a Posi-Temp® or Moentrol® shower valve.

HOW TO ORDER POSI-TEMP SHOWER WITH 2/3 FUNCTION TRANSFER VALVE

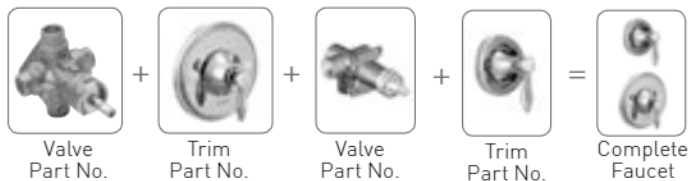

NOTES

 Moen® **M•PACT®** Common Valve System

*Ships Q2

Posi-Temp® Transfer Valve Showering Components

Must order Rough-In-Valve and Trim Pack separately.

All Brushed Nickel, Polished Nickel, Polished Brass and Brushed Gold faucet components feature the Lifeshine® Non-Tarnish Finish.

		MODEL NUMBER	LIST PRICE	FINISH/ CONNECTION	CASE QTY
EVA®	2/3 FUNCTION TRANSFER VALVE				
  	<ul style="list-style-type: none"> • use with 3372 or 3375 transfer valve • valve sold separately 	T2011	122.55	Chrome	12
		T2011BN	185.65	Brushed Nickel	12
		T2011ORB	185.65	Oil Rubbed Bronze	12
MOEN®	TRANSFER VALVE TRIM				
  	<ul style="list-style-type: none"> • use with 3372 or 3375 transfer valve • valve: sold separately 	T4171	126.10	Chrome	6
		T4171BN	189.75	Brushed Nickel	6
		T4171ORB	189.75	Oil Rubbed Bronze	6
WEYMOUTH®	POSI-TEMP® VALVE TRIM				
  	<ul style="list-style-type: none"> • valve sold separately 	TS3210	284.95	Chrome	3
		TS3210BN	427.40	Brushed Nickel	3
		TS3210NL	427.40	Polished Nickel	3
		TS3210ORB	427.40	Oil Rubbed Bronze	3
		NEW! TS3210BG	427.40	Brushed Gold	3
		NEW! TS3210BL*	427.40	Matte Black	-
ARRIS®	POSI-TEMP® VALVE TRIM				
  	<ul style="list-style-type: none"> • valve sold separately 	TS22001	284.95	Chrome	3
		TS22001BN	427.40	Brushed Nickel	3
		NEW! TS22001BL*	427.40	Matte Black	-
WATERHILL®	POSI-TEMP® VALVE TRIM				
  	<ul style="list-style-type: none"> • valve sold separately 	TS310	270.75	Chrome	3
		TS310BN	406.15	Brushed Nickel	3
		TS310ORB	406.15	Oil Rubbed Bronze	3
90 DEGREE™	POSI-TEMP® VALVE TRIM				
  	<ul style="list-style-type: none"> • valve sold separately 	TS2711	172.00	Chrome	3
		TS2711BN	321.60	Brushed Nickel	3

CUSTOM SHOWERING

Use 3372 or 3375 in conjunction with either a Posi-Temp® or Moentrol® shower valve.

HOW TO ORDER POSI-TEMP SHOWER WITH TRANSFER VALVE

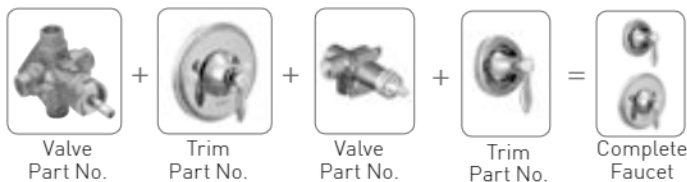

NOTES







 Moen® **M•PACT**® Common Valve System

*Ships Q2

Posi-Temp® Transfer Valve Showering Components

Must order Rough-In-Valve and Trim Pack separately.

All Brushed Nickel, Polished Nickel, Polished Brass and Brushed Gold faucet components feature the Lifeshine® Non-Tarnish Finish.

		MODEL NUMBER	LIST PRICE	FINISH/ CONNECTION	CASE QTY
VIA™ 	POSI-TEMP® VALVE TRIM • red/blue markings: included • valve sold separately	TS8711	172.00	Chrome	3
					
DOUX™ 	POSI-TEMP® VALVE TRIM ONLY • valve sold separately	TS2201	201.20	Chrome	3
		TS2201BN	376.20	Brushed Nickel	3
		TS2201BL	376.20	Matte Black	3
					
ROTHBURY® 	POSI-TEMP® VALVE TRIM • valve sold separately	TS2211	172.00	Chrome	3
		TS2211BN	321.60	Brushed Nickel	3
		TS2211ORB	321.60	Oil Rubbed Bronze	3
					
ICON™ 	POSI-TEMP® VALVE TRIM • valve sold separately	TS2141	155.55	Chrome	3
		TS2141BN	291.05	Brushed Nickel	3
					
WYNFORD™ 	POSI-TEMP® VALVE TRIM • valve sold separately	T4501	142.25	Chrome	3
		T4501BN	268.75	Brushed Nickel	3
		T4501NL	268.75	Polished Nickel	3
		T4501ORB	268.75	Oil Rubbed Bronze	3
					
BELFIELD™ 	POSI-TEMP® VALVE ONLY • valve sold separately	T2311	142.25	Chrome	3
		T2311BN	268.75	Brushed Nickel	3
		T2311ORB	268.75	Oil Rubbed Bronze	3
		T2311NL*	268.75	Polished Nickel	-
					

Use 3372 or 3375 in conjunction with either a Posi-Temp® or Moentrol® shower valve.

HOW TO ORDER POSI-TEMP SHOWER WITH TRANSFER VALVE

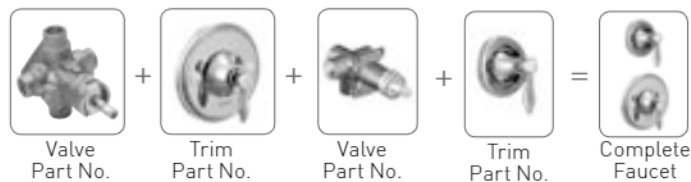

NOTES

Moentrol® M•PACT® Common Valve System

*Ships Q2

Posi-Temp® Transfer Valve Showering Components

Must order Rough-In-Valve and Trim Pack separately.

All Brushed Nickel, Polished Nickel, Polished Brass and Brushed Gold faucet components feature the Lifeshine® Non-Tarnish Finish.

		MODEL NUMBER	LIST PRICE	FINISH/ CONNECTION	CASE QTY
ALIGN® 	POSI-TEMP® VALVE TRIM <ul style="list-style-type: none"> • red/blue markings: included • valve sold separately 	T2191	96.80	Chrome	3
		T2191BN	237.25	Brushed Nickel	3
		T2191BL	237.25	Matte Black	3
		NEW! T2191BG	237.25	Brushed Gold	3
KYVOS™ 	POSI-TEMP® VALVE ONLY <ul style="list-style-type: none"> • red/blue markings: included • valve sold separately 	T2781	100.20	Chrome	3
VOSS™ 	POSI-TEMP® VALVE TRIM <ul style="list-style-type: none"> • valve sold separately 	T2691	142.25	Chrome	3
		T2691BN	268.75	Brushed Nickel	3
		T2691ORB	268.75	Oil Rubbed Bronze	3
		NEW! T2691BG	268.75	Brushed Gold	3
		NEW! T2691NL*	268.75	Polished Nickel	-
KINGSLEY® 	POSI-TEMP® VALVE TRIM <ul style="list-style-type: none"> • valve sold separately 	T2111	142.25	Chrome	3
		T2111BN	268.75	Brushed Nickel	3
		T2111ORB	268.75	Oil Rubbed Bronze	3
RIZON™ 	POSI-TEMP® VALVE TRIM <ul style="list-style-type: none"> • red/blue markings: included • valve sold separately 	T2811	84.20	Chrome	3
		T2811BN	203.35	Brushed Nickel	3
		NEW! T2811BL*	203.35	Matte Black	3
DARTMOOR™ 	POSI-TEMP® VALVE TRIM <ul style="list-style-type: none"> • valve sold separately 	T2181	80.95	Chrome	3
		T2181BN	196.15	Brushed Nickel	3
		T2181ORB	196.15	Oil Rubbed Bronze	3

CUSTOM SHOWERING

Use 3372 or 3375 in conjunction with either a Posi-Temp® or Moentrol® shower valve.

HOW TO ORDER POSI-TEMP SHOWER WITH TRANSFER VALVE

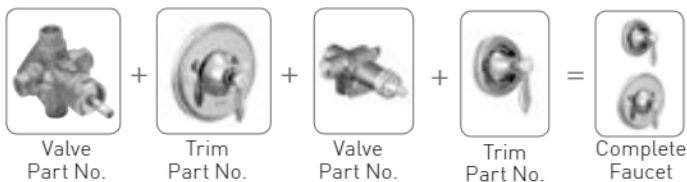

NOTES

 Moen® **M•PACT**® Common Valve System

*Ships Q2

Posi-Temp® Transfer Valve Showering Components

Must order Rough-In-Valve and Trim Pack separately.

All Brushed Nickel, Polished Nickel, Polished Brass and Brushed Gold faucet components feature the Lifeshine® Non-Tarnish Finish.

		MODEL NUMBER	LIST PRICE	FINISH/ CONNECTION	CASE QTY
GLYDE™ 	POSI-TEMP® VALVE TRIM • valve sold separately	T2741	80.95	Chrome	3
		T2741BN	196.15	Brushed Nickel	3
					
BRANTFORD™ 	POSI-TEMP® VALVE TRIM • valve sold separately	T2151	73.65	Chrome	3
		T2151BN	178.35	Brushed Nickel	3
					
EVA® 	POSI-TEMP® VALVE TRIM • valve sold separately	T2131	73.65	Chrome	3
		T2131BN	178.35	Brushed Nickel	3
					
METHOD™ 	POSI-TEMP® VALVE TRIM • red/blue markings: included • valve sold separately	T2801	73.65	Chrome	3
		T2801BN	178.35	Brushed Nickel	3
					
VICHY™ 	POSI-TEMP® VALVE ONLY • red/blue markings: included • valve sold separately	T2661	73.65	Chrome	3
					

CUSTOM SHOWERING

Use 3372 or 3375 in conjunction with either a Posi-Temp® or Moentrol® shower valve.

HOW TO ORDER POSI-TEMP SHOWER WITH TRANSFER VALVE

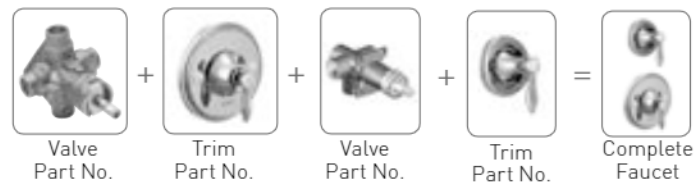







NOTES

Moentrol® M•PACT® Common Valve System

Showerheads

All Brushed Nickel, Polished Nickel, Polished Brass and Brushed Gold faucet components feature the Lifeshine® Non-Tarnish Finish.

SHOWERHEADS		MODEL NUMBER	LIST PRICE	FINISH/ CONNECTION	CASE QTY
	<ul style="list-style-type: none"> • connection size: 1/2" • connection type: IPS • showerhead functions: one-function • showerhead type: rainshower • showerhead size: 8" diameter spray head • type of function: rainfall • flow rate: 2.5 gpm (9.5 L/min) max. 	S1005	420.85	Chrome	3
	<ul style="list-style-type: none"> • flow rate: 1.75 gpm (6.7 L/min) max. 	S1005EP	420.85	Chrome	3
	<ul style="list-style-type: none"> • connection size: 1/2" • connection type: IPS • showerhead functions: one-function • showerhead type: rainshower • showerhead size: 10" diameter spray head • type of function: rainfall • flow rate: 2.5 gpm (9.5 L/min) max. 	S1001	448.50	Chrome	3
	<ul style="list-style-type: none"> • flow rate: 1.75 gpm (6.7 L/min) max. 	S1001EP	448.50	Chrome	3
	<ul style="list-style-type: none"> • connection size: 1/2" • connection type: IPS • showerhead functions: one-function • showerhead type: rainshower • showerhead size: 10" diameter spray head • type of function: rainfall • flow rate: 2.5 gpm (9.5 L/min) max. 	S1003	470.65	Chrome	3
	<ul style="list-style-type: none"> • flow rate: 1.75 gpm (6.7 L/min) max. 	S1003EP	470.65	Chrome	3
	<ul style="list-style-type: none"> • connection size: 1/2" • connection type: IPS • showerhead functions: one-function • showerhead type: rainshower • showerhead size: 8" diameter spray head • type of function: rainfall • flow rate: 2.5 gpm (9.5 L/min) max. 	S1006	443.00	Chrome	3
	<ul style="list-style-type: none"> • flow rate: 1.75 gpm (6.7 L/min) max. 	S1006EP	443.00	Chrome	3
	<ul style="list-style-type: none"> • connection size: 1/2" • connection type: IPS • showerhead functions: one-function • showerhead type: rainshower • showerhead size: 12" diameter spray head • type of function: rainfall • flow rate: 2.5 gpm (9.5 L/min) max. 	S1002	476.20	Chrome	3
	<ul style="list-style-type: none"> • flow rate: 1.75 gpm (6.7 L/min) max. 	S1002EP	476.20	Chrome	3
	<ul style="list-style-type: none"> • connection size: 1/2" • connection type: IPS • showerhead functions: one-function • showerhead type: rainshower • showerhead size: 12" diameter spray head • type of function: rainfall • flow rate: 2.5 gpm (9.5 L/min) max. 	S1004	498.35	Chrome	3
	<ul style="list-style-type: none"> • flow rate: 1.75 gpm (6.7 L/min) max. 	S1004EP	498.35	Chrome	3
	<ul style="list-style-type: none"> • connection size: 1/2" 	S1311	434.65	Chrome	3
	<ul style="list-style-type: none"> • connection type: IPS 	S1311BN	595.10	Brushed Nickel	3
	<ul style="list-style-type: none"> • showerhead functions: two-function 	S1311NL	595.10	Polished Nickel	3
	<ul style="list-style-type: none"> • showerhead type: rainshower 	S1311ORB	595.10	Oil Rubbed Bronze	3
	<ul style="list-style-type: none"> • showerhead size: 9" diameter spray head 	S1311BG	595.10	Brushed Gold	3
	<ul style="list-style-type: none"> • type of function: concentrated rinse; full spray 	S1311BL*	595.10	Matte Black	-

CUSTOM SHOWERING

IMMERSION











NOTES

IMMERSION Immersion® Rainshower

*Ships Q2

Showerheads

All Brushed Nickel, Polished Nickel, Polished Brass and Brushed Gold faucet components feature the Lifeshine® Non-Tarnish Finish.

		MODEL NUMBER	LIST PRICE	FINISH/ CONNECTION	CASE QTY
SHOWERHEADS [CONTINUED]					
 <ul style="list-style-type: none"> • connection size: 1/2" • connection type: IPS • showerhead functions: two-function • showerhead type: eco-performance rainshower • showerhead size: 9" diameter spray head • type of function: concentrated rinse; full spray • flow rate: 1.75 gpm (6.65/Lmin) 		S1311EP	434.65	Chrome	3
		S1311EPBN	595.10	Brushed Nickel	3
		S1311EPNL	595.10	Polished Nickel	3
		S1311EPORB	595.10	Oil Rubbed Bronze	3
		S1311EPBG	595.10	Brushed Gold	3
		S1311EPBL*	595.10	Matte Black	-
	 IMMERSION				
 <ul style="list-style-type: none"> • connection size: 1/2" • connection type: IPS • showerhead functions: one-function • showerhead type: rainshower • showerhead size: 10" diameter spray head • type of function: full spray • flow rate: 2.5 gpm (9.5 L/min) max. 		S112	404.20	Chrome	3
		S112BN	537.30	Brushed Nickel	3
		S112NL	537.30	Polished Nickel	3
		S112ORB	537.30	Oil Rubbed Bronze	3
		S112WR	537.30	Wrought Iron	3
	IMMERSION				
 <ul style="list-style-type: none"> • connection size: 1/2" • connection type: IPS • showerhead functions: one-function • showerhead type: eco-performance rainshower • showerhead size: 10" diameter spray head • type of function: full spray • flow rate: 1.75 gpm (6.65/Lmin) 		S112EP	404.20	Chrome	3
		S112EPBN	537.30	Brushed Nickel	3
		S112EPNL	537.30	Polished Nickel	3
		S112EPORB	537.30	Oil Rubbed Bronze	3
		S112EPWR	537.30	Wrought Iron	-
	 IMMERSION				
 <ul style="list-style-type: none"> • connection size: 1/2" • connection type: IPS • showerhead functions: two-function • showerhead type: rainshower • showerhead size: 8" diameter spray head • type of function: concentrated rinse; full spray • flow rate: 2.5 gpm (9.5 L/min) max. 		S6320	288.70	Chrome	3
		S6320BN	486.80	Brushed Nickel	3
		S6320ORB	486.80	Oil Rubbed Bronze	3
		S6320BG	486.80	Brushed Gold	3
	IMMERSION				
 <ul style="list-style-type: none"> • connection size: 1/2" • connection type: IPS • showerhead functions: two-function • showerhead type: eco-performance rainshower • showerhead size: 8" diameter spray head • type of function: concentrated rinse; full spray • flow rate: 1.75 gpm (6.65/Lmin) 		S6320EP	288.70	Chrome	3
		S6320EPBN	486.80	Brushed Nickel	3
		S6320EPORB	486.80	Oil Rubbed Bronze	3
		S6320EPBG	486.80	Brushed Gold	3
	 IMMERSION				
 <ul style="list-style-type: none"> • connection size: 1/2" • connection type: IPS • showerhead functions: one-function • showerhead type: rainshower • showerhead size: 8" diameter spray head • type of function: full spray • flow rate: 2.5 gpm (9.5 L/min) max. 		S6360	257.65	Chrome	3
		S6360BN	420.95	Brushed Nickel	3
		S6360ORB	420.95	Oil Rubbed Bronze	3
	IMMERSION				
 <ul style="list-style-type: none"> • connection size: 1/2" • connection type: IPS • showerhead functions: one-function • showerhead type: eco-performance rainshower • showerhead size: 8" diameter spray head • type of function: full rainshower; full spray • flow rate: 1.75 gpm (6.65/Lmin) 		S6360EP	257.65	Chrome	3
		S6360EPBN	420.95	Brushed Nickel	3
		S6360EPORB	420.95	Oil Rubbed Bronze	3
	 IMMERSION				

CUSTOM SHOWERING











NOTES

IMMERSION Immersion® Rainshower

*Ships Q2

Showerheads

All Brushed Nickel, Polished Nickel, Polished Brass and Brushed Gold faucet components feature the Lifeshine® Non-Tarnish Finish.

SHOWERHEADS [CONTINUED]		MODEL NUMBER	LIST PRICE	FINISH/ CONNECTION	CASE QTY
	<ul style="list-style-type: none"> • connection size: 1/2" • connection type: IPS • showerhead functions: one-function • showerhead type: rainshower • showerhead size: 7" diameter spray head • type of function: full spray • flow rate: 2.5 gpm (9.5 L/min) max. 	S176	212.95	Chrome	3
		S176BN	317.20	Brushed Nickel	3
		S176BL	317.20	Matte Black	3
		NEW! S176BG	317.20	Brushed Gold	3
		IMMERSION®			
	<ul style="list-style-type: none"> • connection size: 1/2" • connection type: IPS • showerhead functions: one-function • showerhead type: eco-performance rainshower • showerhead size: 7" diameter spray head • type of function: full spray • flow rate: 1.75 gpm (6.65/Lmin) 	S176EP	212.95	Chrome	3
		S176EPBN	317.20	Brushed Nickel	3
		S176EPBL	317.20	Matte Black	3
		NEW! S176EPBG	317.20	Brushed Gold	3
		 IMMERSION®			
	<ul style="list-style-type: none"> • connection size: 1/2" • connection type: IPS • showerhead functions: one-function • showerhead type: rainshower • showerhead size: 7" diameter spray head • type of function: full spray • flow rate: 2.5 gpm (9.5 L/min) max. 	S6310	211.90	Chrome	3
		S6310BN	315.65	Brushed Nickel	3
		S6310ORB	315.65	Oil Rubbed Bronze	3
		IMMERSION®			
	<ul style="list-style-type: none"> • connection size: 1/2" • connection type: IPS • showerhead functions: one-function • showerhead type: eco-performance rainshower • showerhead size: 7" diameter spray head • type of function: full spray • flow rate: 1.75 gpm (6.65/Lmin) 	S6310EP	211.90	Chrome	3
		S6310EPBN	315.65	Brushed Nickel	3
		S6310EPORB	315.65	Oil Rubbed Bronze	3
		 IMMERSION®			
	<ul style="list-style-type: none"> • connection size: 1/2" • connection type: IPS • showerhead functions: one-function • showerhead type: eco-performance rainshower • showerhead size: 8" diameter spray head • type of function: full rainshower • flow rate: 2.0 gpm (7.6 L/min) max. 	6345	122.55	Chrome	3
		6345BN	173.20	Brushed Nickel	3
		6345ORB	173.20	Oil Rubbed Bronze	3
		 IMMERSION®			
	<ul style="list-style-type: none"> • connection size: 1/2" • connection type: IPS • showerhead functions: two-function • showerhead type: rainshower • showerhead size: 8-1/2" diameter spray head • type of function: combination; concentrated rinse; full rainshower • flow rate: 2.5 gpm (9.5 L/min) max. 	S6345	303.20	Chrome	3
		S6345BN	511.15	Brushed Nickel	3
		NEW! S6345BG	511.15	Brushed Gold	3
		IMMERSION®			
	<ul style="list-style-type: none"> • connection size: 1/2" • connection type: IPS • showerhead functions: two-function • showerhead type: eco-performance rainshower • showerhead size: 8-1/2" diameter spray head • type of function: combination; concentrated rinse; full rainshower • flow rate: 1.75 gpm (6.65/Lmin). 	S6345EP	303.20	Chrome	3
		S6345EPBN	511.15	Brushed Nickel	3
		NEW! S6345EPBG	511.15	Brushed Gold	3
		 IMMERSION®			



















CUSTOM SHOWERING

NOTES

IMMERSION® Immersion® Rainshower

Showerheads

All Brushed Nickel, Polished Nickel, Polished Brass and Brushed Gold faucet components feature the Lifeshine® Non-Tarnish Finish.

		MODEL NUMBER	LIST PRICE	FINISH/ CONNECTION	CASE QTY
SHOWERHEADS [CONTINUED]					
	<ul style="list-style-type: none"> • connection size: 1/2" • connection type: IPS • showerhead functions: one-function • showerhead type: rainshower • showerhead size: 6" diameter spray head • type of function: full spray • flow rate: 2.5 gpm (9.5 L/min) max. 	S6340	151.15	Chrome	3
		S6340BN	243.45	Brushed Nickel	3
		IMMERSION			
	<ul style="list-style-type: none"> • connection size: 1/2" • connection type: IPS • showerhead functions: one-function • showerhead type: eco-performance rainshower • showerhead size: 6" diameter spray head • type of function: full spray • flow rate: 1.75 gpm (6.65 L/min) max. 	S6340EP	151.15	Chrome	3
		S6340EPBN	243.45	Brushed Nickel	3
		 IMMERSION			
	<ul style="list-style-type: none"> • connection size: 1/2" • connection type: IPS • showerhead functions: one-function • showerhead type: rainshower • showerhead size: 6" diameter spray head • type of function: full spray • flow rate: 2.5 gpm (9.5 L/min) max. 	S6365	151.15	Chrome	3
		S6365BN	243.45	Brushed Nickel	3
		S6365ORB	243.45	Oil Rubbed Bronze	3
		S6365BG	243.45	Brushed Gold	3
		S6365NL*	243.45	Polished Nickel	-
		   S6365BL*	243.45	Matte Black	-
		IMMERSION			
	<ul style="list-style-type: none"> • connection size: 1/2" • connection type: IPS • showerhead functions: one-function • showerhead type: eco-performance rainshower • showerhead size: 6" diameter spray head • type of function: full spray • flow rate: 1.75 gpm (6.65/Lmin). 	S6365EP	151.15	Chrome	3
		S6365EPBN	243.45	Brushed Nickel	3
		S6365EPORB	243.45	Oil Rubbed Bronze	3
		S6365EPBG	243.45	Brushed Gold	3
		S6365EPNL*	243.45	Polished Nickel	-
		   S6365EPBL*	243.45	Matte Black	-
		 IMMERSION			
	<ul style="list-style-type: none"> • connection size: 1/2" • connection type: IPS • showerhead functions: one-function • showerhead type: standard • showerhead size: 6-1/2" diameter spray head • type of function: full spray • flow rate: 2.5 gpm (9.5 L/min) max. 	S6335	151.15	Chrome	6
		S6335BN	243.45	Brushed Nickel	6
		S6335ORB	243.45	Oil Rubbed Bronze	6
	<ul style="list-style-type: none"> • connection size: 1/2" • connection type: IPS • showerhead functions: one-function • showerhead type: eco-performance showerhead • showerhead size: 6-1/2" diameter spray head • type of function: full spray • flow rate: 1.75 gpm (6.65/Lmin). 	S6335EP	151.15	Chrome	6
		S6335EPBN	243.45	Brushed Nickel	6
		S6335EPORB	243.45	Oil Rubbed Bronze	6
		 IMMERSION			
	<ul style="list-style-type: none"> • connection size: 1/2" • connection type: IPS • showerhead functions: one-function • showerhead type: standard • showerhead size: 5-7/8" diameter spray head • type of function: full spray • flow rate: 2.5 gpm (9.5 L/min) max. 	S6312	143.80	Chrome	12
		S6312BN	185.05	Brushed Nickel	12
	<ul style="list-style-type: none"> • connection size: 1/2" • connection type: IPS • showerhead functions: one-function • showerhead type: eco-performance showerhead • showerhead size: 5-7/8" diameter spray head • type of function: full spray • flow rate: 1.75 gpm (6.65 L/min) max. 	S6312EP	143.80	Chrome	12
		S6312EPBN	185.05	Brushed Nickel	12
		 IMMERSION			

NOTES

IMMERSION Immersion® Rainshower

*Ships Q2

Showerheads











All Brushed Nickel, Polished Nickel, Polished Brass and Brushed Gold faucet components feature the Lifeshine® Non-Tarnish Finish.

SHOWERHEADS [CONTINUED]		MODEL NUMBER	LIST PRICE	FINISH/ CONNECTION	CASE QTY
 <ul style="list-style-type: none"> • connection size: 1/2" • connection type: IPS • showerhead functions: three-function • showerhead type: eco-performance showerhead • showerhead size: 4" diameter spray head • type of function: combination; concentrated rinse; full spray • flow rate: 1.75 gpm (6.65 L/min) max. 		3233EP	121.10	Chrome	12
		3233EPBN	172.05	Brushed Nickel	12
 <ul style="list-style-type: none"> • connection size: 1/2" • connection type: IPS • showerhead functions: four-function • showerhead type: standard • showerhead size: 4-3/8" diameter spray head • type of function: combination; full spray; invigorating spray; targeted massage • flow rate: 2.5 gpm (9.5 L/min) max. 		3638	125.80	Chrome	12
		3638BN	178.75	Brushed Nickel	12
		3638ORB	178.75	Oil Rubbed Bronze	12
 <ul style="list-style-type: none"> • connection size: 1/2" • connection type: IPS • showerhead functions: four-function • showerhead type: eco-performance showerhead • showerhead size: 4-3/8" diameter spray head • type of function: combination; full spray; invigorating spray; targeted massage • flow rate: 1.75 gpm (6.65/Lmin). 		3638EP	125.80	Chrome	12
		3638EPBN	178.75	Brushed Nickel	12
 <ul style="list-style-type: none"> • connection size: 1/2" • connection type: IPS • showerhead functions: one-function • showerhead type: standard • showerhead size: 4-3/8" diameter spray head • type of function: full spray • flow rate: 2.5 gpm (9.5 L/min) max. 		6302	113.70	Chrome	12
		6302BN	152.95	Brushed Nickel	12
		6302ORB	152.95	Oil Rubbed Bronze	12
		6302WR	152.95	Wrought Iron	12
		6302P	152.95	Polished Brass	12
 <ul style="list-style-type: none"> • connection size: 1/2" • connection type: IPS • showerhead functions: one-function • showerhead type: eco-performance showerhead • showerhead size: 4-3/8" diameter spray head • type of function: full spray • flow rate: 1.75 gpm (6.65 L/min) max. 		6302EP	113.70	Chrome	12
		6302EPBN	152.95	Brushed Nickel	12
		6302EORB	152.95	Oil Rubbed Bronze	12
		6302EPP	152.95	Polished Brass	12

CUSTOM SHOWERING

Showerheads

All Brushed Nickel, Polished Nickel, Polished Brass and Brushed Gold faucet components feature the Lifeshine® Non-Tarnish Finish.







		MODEL NUMBER	LIST PRICE	FINISH/ CONNECTION	CASE QTY
SHOWERHEADS [CONTINUED]					
	<ul style="list-style-type: none"> • connection size: 1/2" • connection type: IPS • showerhead functions: one-function • showerhead type: standard • showerhead size: 4-1/16" diameter spray head • type of function: full spray • flow rate: 2.5 gpm (9.5 L/min) max. 	6325	113.70	Chrome	12
		6325BN	152.95	Brushed Nickel	12
		6325ORB	152.95	Oil Rubbed Bronze	12
		NEW 6325BG	152.95	Brushed Gold	12
		NEW 6325NL*	152.95	Polished Nickel	-
	<ul style="list-style-type: none"> • connection size: 1/2" • connection type: IPS • showerhead functions: one-function • showerhead type: eco-performance showerhead • showerhead size: 4-1/16" diameter spray head • type of function: full spray • flow rate: 1.75 gpm (6.65 L/min) max. 	6325EP	113.70	Chrome	12
		6325EPBN	152.95	Brushed Nickel	12
		6325EPORB	152.95	Oil Rubbed Bronze	12
		NEW 6325EPBG	152.95	Brushed Gold	12
		NEW 6325EPNL*	152.95	Polished Nickel	-
					
	<ul style="list-style-type: none"> • connection size: 1/2" • connection type: IPS • showerhead functions: one-function • showerhead type: standard • showerhead size: 3-5/8" diameter spray head • type of function: full spray • flow rate: 2.5 gpm (9.5 L/min) max. 	6399	93.25	Chrome	12
		6399BN	128.80	Brushed Nickel	12
		6399BL	128.80	Matte Black	12
		NEW 6399BG	128.80	Brushed Gold	12
	<ul style="list-style-type: none"> • connection size: 1/2" • connection type: IPS • showerhead functions: one-function • showerhead type: eco-performance showerhead • showerhead size: 3-5/8" diameter spray head • type of function: full spray • flow rate: 1.75 gpm (6.65 L/min) max. 	6399EP	93.25	Chrome	12
		6399EPBN	128.80	Brushed Nickel	12
		6399EPBL	128.80	Matte Black	12
		NEW 6399EPBG	128.80	Brushed Gold	12
					
	<ul style="list-style-type: none"> • connection size: 1/2" • connection type: IPS • showerhead functions: one-function • showerhead type: standard • showerhead size: 3-3/8" diameter spray head • type of function: full spray • flow rate: 2.5 gpm (9.5 L/min) max. 	6303	64.30	Chrome	12
		6303BN	100.65	Brushed Nickel	12
		6303ORB	100.65	Oil Rubbed Bronze	12
	<ul style="list-style-type: none"> • connection size: 1/2" • connection type: IPS • showerhead functions: one-function • showerhead type: eco-performance showerhead • showerhead size: 3-3/8" diameter spray head • type of function: full spray • flow rate: 1.75 gpm (6.65 L/min) max. 	6303EP	64.30	Chrome	12
		6303EPBN	100.65	Brushed Nickel	12
		6303EPORB	100.65	Oil Rubbed Bronze	12
					
	<ul style="list-style-type: none"> • connection size: 1/2" • connection type: IPS • showerhead functions: one-function • showerhead type: eco-performance showerhead • showerhead size: 3.5" diameter spray head • type of function: full spray • flow rate: 1.5 gpm (5.7 L/min) max. 	6313	64.30	Chrome	12
		6313BN	100.65	Brushed Nickel	12
		6313ORB	100.65	Oil Rubbed Bronze	12
					

NOTES

*Ships Q2

Showerheads

All Brushed Nickel, Polished Nickel, Polished Brass and Brushed Gold faucet components feature the Lifeshine® Non-Tarnish Finish.

SHOWERHEADS [CONTINUED]		MODEL NUMBER	LIST PRICE	FINISH/ CONNECTION	CASE QTY
	<ul style="list-style-type: none"> • connection size: 1/2" • connection type: IPS • showerhead functions: one-function • showerhead type: standard • showerhead size: 3-7/8" diameter spray head • type of function: full spray • flow rate: 2.5 gpm (9.5 L/min) max. 	6370	70.75	Chrome	12
		6370BN	110.65	Brushed Nickel	12
	<ul style="list-style-type: none"> • connection size: 1/2" • connection type: IPS • showerhead functions: one-function • showerhead type: eco-performance showerhead • showerhead size: 3-7/8" diameter spray head • type of function: full spray • flow rate: 1.75 gpm (6.65 L/min) max. 	6370EP	70.75	Chrome	12
		6370EPBN	110.65	Brushed Nickel	3
	<ul style="list-style-type: none"> • connection size: 1/2" • connection type: IPS • showerhead functions: one-function • showerhead type: standard • showerhead size: 4" diameter spray head • type of function: full spray • flow rate: 2.5 gpm (9.5 L/min) max. 	6371	70.75	Chrome	12
		6371BN	110.65	Brushed Nickel	12
		6371ORB	110.65	Oil Rubbed Bronze	12
	<ul style="list-style-type: none"> • connection size: 1/2" • connection type: IPS • showerhead functions: one-function • showerhead type: eco-performance showerhead • showerhead size: 4" diameter spray head • type of function: full spray • flow rate: 1.75 gpm (6.65 L/min) max. 	6371EP	70.75	Chrome	12
		6371EPBN	110.65	Brushed Nickel	12
		6371EPORB	110.65	Oil Rubbed Bronze	12
	<ul style="list-style-type: none"> • connection size: 1/2" • connection type: IPS • showerhead functions: one-function • showerhead type: standard • showerhead size: 3-3/4" diameter spray head • type of function: full spray • flow rate: 2.5 gpm (9.5 L/min) max. 	6322	93.25	Chrome	12
		6322BN	131.15	Brushed Nickel	1
		NEW 6322BL*	131.15	Matte Black	12
	<ul style="list-style-type: none"> • connection size: 1/2" • connection type: IPS • showerhead functions: one-function • showerhead type: eco-performance showerhead • showerhead size: 3-3/4" diameter spray head • type of function: full spray • flow rate: 1.75 gpm (6.65 L/min) max. 	6322EP	93.25	Chrome	12
		6322EPBN	131.15	Brushed Nickel	1
		NEW 6322EPBL*	131.15	Matte Black	12











CUSTOM SHOWERING

NOTES

*Ships Q2

Showerheads

All Brushed Nickel, Polished Nickel, Polished Brass and Brushed Gold faucet components feature the Lifeshine® Non-Tarnish Finish.

		MODEL NUMBER	LIST PRICE	FINISH/ CONNECTION	CASE QTY
SHOWERHEADS [CONTINUED]					
	<ul style="list-style-type: none"> • connection size: 1/2" • connection type: IPS • showerhead functions: one-function • showerhead type: standard • showerhead size: 2-1/2" diameter spray head • type of function: full spray • flow rate: 2.5 gpm (9.5 L/min) max. 	6300	18.20	Chrome	12
		6300BN	74.05	Brushed Nickel	12
		6300P	74.05	Polished Brass	12
	<ul style="list-style-type: none"> • connection size: 1/2" • connection type: IPS • showerhead functions: one-function • showerhead type: eco-performance showerhead • showerhead size: 2-1/2" diameter spray head • type of function: full spray • flow rate: 1.75 gpm (6.65 L/min) max. 	6300EP	18.20	Chrome	12
		6300EPBN	74.05	Brushed Nickel	12
					
	<ul style="list-style-type: none"> • connection size: 1/2" • connection type: IPS • showerhead functions: one-function • showerhead type: eco-performance showerhead • showerhead size: 2-1/2" diameter spray head • type of function: full spray • flow rate: 1.5 gpm (5.7 L/min) max. 	6300EP15	18.20	Chrome	12
					
	<ul style="list-style-type: none"> • connection size: 1/2" • connection type: IPS • showerhead functions: one-function • showerhead type: standard • showerhead size: 2-1/2" diameter spray head • type of function: full spray • flow rate: 2.5 gpm (9.5 L/min) max. • shower arm included • shower arm flange included 	6304	25.25	Chrome	12
	<ul style="list-style-type: none"> • connection size: 1/2" • connection type: IPS • showerhead functions: one-function • showerhead type: eco-performance showerhead • showerhead size: 3-1/2" diameter spray head • type of function: full spray • flow rate: 1.75 gpm (6.65 L/min) max. • shower arm included • shower arm flange included 	6304EP	25.25	Chrome	12
					

Handheld Showers

All Brushed Nickel, Polished Nickel, Polished Brass and Brushed Gold faucet components feature the Lifeshine® Non-Tarnish Finish.

	MODEL NUMBER	LIST PRICE	FINISH/ CONNECTION	CASE QTY
--	--------------	------------	--------------------	----------

HANDHELD SHOWER



- showerhead functions: six-function
- showerhead type: eco-performance handshower
- showerhead size: 5.5" diameter spray head
- type of function: wide coverage; downpour; rinse; massage; relaxing massage; invigorating spray
- flow rate: 1.75 gpm (6.65 L/min) max.
- double check valve: included
- includes: magnetix docking system



3662EP	255.45	Chrome	6
3662EPBN	378.50	Brushed Nickel	6
3662EPORB	378.50	Oil Rubbed Bronze	6

HANDHELD SHOWER



- showerhead functions: six-function
- showerhead type: eco-performance handshower
- showerhead size: 3.5" diameter spray head
- type of function: combination
- flow rate: 1.75 gpm (6.65 L/min) max.
- arm and flange sold separately



26100EP	93.40	Chrome	2
26100EPSRN	115.25	Spot Resist Brushed Nickel	2

SHOWER RAIL



- connection size: 1/2"
- connection type: IPS
- showerhead type: showerhead sold separately
- handshower type: handshower sold separately
- type of function: two independent functions
- hose length: 59"

TS3661NH	561.25	Chrome	3
TS3661NHBN	833.20	Brushed Nickel	3
TS3661NHBL	833.20	Matte Black	3
TS3661NHORB	833.20	Oil Rubbed Bronze	3

HANDHELD



- showerhead functions: one-function
- showerhead type: eco-performance handshower
- showerhead size: 3-3/8" diameter spray head
- type of function: full spray
- flow rate: 1.75 gpm (6.65 L/min) max.
- slide bar length: 30"
- hose length: 69"
- double check valve: included
- slide bar: not to be used as a grab bar
- drop ell: sold separately
- use secure mount anchor: to meet hand grip requirements



S12107EP	420.45	Chrome	6
S12107EPBN	808.40	Brushed Nickel	6
S12107EPNL	808.40	Polished Nickel	6
S12107EPORB	808.40	Oil Rubbed Bronze	6
NEW S12107EPBG	808.40	Brushed Gold	6















SECUREMOUNT ANCHORS SOLD SEPARATELY

A750	48.65	N/A or Unfinished	24
-------------	-------	-------------------	----

CUSTOM SHOWERING

Handheld Showers

All Brushed Nickel, Polished Nickel, Polished Brass and Brushed Gold faucet components feature the Lifeshine® Non-Tarnish Finish.

		MODEL NUMBER	LIST PRICE	FINISH/ CONNECTION	CASE QTY	
HANDHELD [CONTINUED]						
	<ul style="list-style-type: none"> • showerhead functions: four-function • showerhead type: eco-performance handshower • showerhead size: 3-3/4" diameter spray head • type of function: drench; soothe; immerse; shine • flow rate: 1.75 gpm (6.65 L/min) max. • slide bar length: 30" • hose length: 69" • double check valve: included • slide bar: not to be used as a grab bar • drop ell: sold separately • use secure mount anchor: to meet hand grip requirements 	S3870EP	381.85	Chrome	6	
		S3870EPBN	831.80	Brushed Nickel	6	
		S3870EPORB	831.80	Oil Rubbed Bronze	6	
		SECUREMOUNT ANCHORS SOLD SEPARATELY				
		A750	48.65	N/A or Unfinished	24	
		 				
	<ul style="list-style-type: none"> • showerhead functions: one-function • showerhead type: eco-performance handshower • showerhead size: 3" diameter spray head • type of function: full spray • flow rate: 1.75 gpm (6.65 L/min) max. • slide bar length: 30" • hose length: 69" • double check valve: included • slide bar: not to be used as a grab bar • drop ell: sold separately • use secure mount anchor: to meet hand grip requirements 	S3879EP	420.45	Chrome	6	
		S3879EPBN	808.40	Brushed Nickel	6	
		SECUREMOUNT ANCHORS SOLD SEPARATELY				
			A750	48.65	N/A or Unfinished	24
		 				
	<ul style="list-style-type: none"> • showerhead functions: one-function • showerhead type: square handshower • showerhead size: 1" diameter spray head • type of function: full spray • flow rate: 1.75 gpm (6.65 L/min) max • slide bar length: 30" • hose length: 69" • double check valve: included • slide bar: not to be used as a grab bar • metal construction • drop ell: sold separately • use secure mount anchor: to meet hand grip requirements 	S3880EP	420.45	Chrome	6	
		S3880EPBN	808.40	Brushed Nickel	6	
		SECUREMOUNT ANCHORS SOLD SEPARATELY				
			A750	48.65	N/A or Unfinished	24
		 				
	<ul style="list-style-type: none"> • showerhead functions: one-function • showerhead type: eco-performance handshower • showerhead size: 2" diameter spray head • type of function: full spray • flow rate: 1.75 gpm (6.65 L/min) max. • slide bar length: 30" • hose length: 69" • double check valve: included • slide bar: not to be used as a grab bar • drop ell: sold separately • use secure mount anchor: to meet hand grip requirements 	3869EP	426.80	Chrome	6	
		3869EPBN	745.45	Brushed Nickel	6	
		3869EPORB	745.45	Oil Rubbed Bronze	6	
		3869EPWR	745.45	Wrought Iron	6	
		SECUREMOUNT ANCHORS SOLD SEPARATELY				
			A750	48.65	N/A or Unfinished	24
		 				
	<ul style="list-style-type: none"> • showerhead functions: four-function • showerhead type: eco-performance handshower • showerhead size: 4-3/8" diameter spray head • type of function: combination; full spray; invigorating spray; targeted massage • flow rate: 1.75 gpm (6.65 L/min) max. • slide bar length: 30" • hose length: 69" • double check valve: included • slide bar: not to be used as a grab bar • drop ell: sold separately • use secure mount anchor: to meet hand grip requirements 	3667EP	326.55	Chrome	6	
		3667EPBN	745.45	Brushed Nickel	6	
		3667EPORB	745.45	Oil Rubbed Bronze	6	
		3667EPNL*	745.45	Polished Nickel	6	
		SECUREMOUNT ANCHORS SOLD SEPARATELY				
			A750	48.65	N/A or Unfinished	24
		 				

NOTES

*Ships Q2

Handheld Showers

All Brushed Nickel, Polished Nickel, Polished Brass and Brushed Gold faucet components feature the Lifeshine® Non-Tarnish Finish.

HANDHELD [CONTINUED]



- showerhead functions: four-function
- showerhead type: eco-performance handshower
- showerhead size: 4" diameter spray head
- type of function: combination; full spray; invigorating spray; targeted massage
- flow rate: 1.75 gpm (6.65 L/min) max.
- slide bar length: 30"
- hose length: 69"
- double check valve: included
- slide bar: not to be used as a grab bar
- drop ell: sold separately
- use secure mount anchor: to meet hand grip requirements



MODEL NUMBER	LIST PRICE	FINISH/ CONNECTION	CASE QTY
3669EP	326.55	Chrome	6
3669EPBN	745.45	Brushed Nickel	6
3669EPORB	745.45	Oil Rubbed Bronze	6
NEW! 3669EPBL*	745.45	Matte Black	-

SECUREMOUNT ANCHORS SOLD SEPARATELY

A750	48.65	N/A or Unfinished	24
-------------	-------	-------------------	----



- showerhead functions: one-function
- showerhead type: eco-performance handshower
- showerhead size: 1-1/8" diameter spray head
- type of function: full spray
- flow rate: 1.75 gpm (6.65 L/min) max.
- slide bar length: 30"
- hose length: 69"
- double check valve: included
- slide bar: not to be used as a grab bar
- drop ell: sold separately
- use secure mount anchor: to meet hand grip requirements



3887EP	352.95	Chrome	6
3887EPBN	745.45	Brushed Nickel	6
3887EPBL	745.45	Matte Black	6
NEW! 3887EPBG	745.45	Brushed Gold	6

SECUREMOUNT ANCHORS SOLD SEPARATELY

A750	48.65	N/A or Unfinished	24
-------------	-------	-------------------	----



- showerhead functions: one-function
- showerhead type: handshower
- showerhead size: 1-1/8" diameter spray head
- type of function: full spray
- flow rate: 1.75 gpm (6.65 L/min) max.
- slide bar length: 30"
- hose length: 69"
- double check valve: included
- slide bar: not to be used as a grab bar
- drop ell: sold separately
- use secure mount anchor: to meet hand grip requirements



3988EP	370.55	Chrome	6
3988EPBN	763.45	Brushed Nickel	6
3988EPORB	763.45	Oil Rubbed Bronze	6
NEW! 3988EPNL*	763.45	Polished Nickel	6

SECUREMOUNT ANCHORS SOLD SEPARATELY

A750	48.65	N/A or Unfinished	24
-------------	-------	-------------------	----



- showerhead functions: three-function
- showerhead type: eco-performance handshower
- showerhead size: 4" diameter spray head
- type of function: full spray; concentrated rinse; combination
- flow rate: 1.75 gpm (6.65 L/min) max.
- slide bar length: 30"
- hose length: 69"
- double check valve: included
- slide bar: not to be used as a grab bar
- drop ell: sold separately
- use secure mount anchor: to meet hand grip requirements



3863EP	326.55	Chrome	6
3863EPBN	745.45	Brushed Nickel	6

NOTES

*Ships Q2

Handheld Showers

All Brushed Nickel, Polished Nickel, Polished Brass and Brushed Gold faucet components feature the Lifeshine® Non-Tarnish Finish.

HANDHELD [CONTINUED]



- showerhead functions: one-function
- showerhead type: eco-performance handshower
- showerhead size: 4-1/4" diameter spray head
- type of function: full spray
- flow rate: 1.75 gpm (6.65 L/min) max.
- slide bar length: 24"
- hose length: 59"
- double check valve: included
- slide bar: not to be used as a grab bar
- drop ell: sold separately
- use secure mount anchor: to meet hand grip requirements



MODEL NUMBER	LIST PRICE	FINISH/ CONNECTION	CASE QTY
3668EP	265.60	Chrome	6
3668EPBN	432.20	Brushed Nickel	6
3668EPORB	432.20	Oil Rubbed Bronze	6
SECUREMOUNT ANCHORS SOLD SEPARATELY			
A750	48.65	N/A or Unfinished	24



- showerhead functions: one-function
- showerhead type: eco-performance showerhead
- showerhead size: 4" diameter spray head
- type of function: full spray
- flow rate: 1.75 gpm (6.65 L/min) max.
- slide bar length: 24"
- hose length: 59"
- double check valve: included
- slide bar: not to be used as a grab bar
- drop ell: sold separately
- use secure mount anchor: to meet hand grip requirements



3868EP	265.60	Chrome	6
3868EPBN	432.20	Brushed Nickel	6
3868EPORB	432.20	Oil Rubbed Bronze	6
3868EPBG	432.20	Brushed Gold	6
SECUREMOUNT ANCHORS SOLD SEPARATELY			
A750	48.65	N/A or Unfinished	24



- showerhead functions: five-function
- showerhead type: eco-performance handshower
- showerhead size: 4-3/8" diameter spray head
- type of function: downpour; rinse; massage; relaxing massage; full spray
- flow rate: 1.75 gpm (6.65 L/min) max.
- slide bar length: 30"
- hose length: 69"
- double check valve: included
- slide bar: not to be used as a grab bar
- drop ell: sold separately
- use secure mount anchor: to meet hand grip requirements



3558EP	326.55	Chrome	6
3558EPBN	745.45	Brushed Nickel	6
3558EPORB	745.45	Oil Rubbed Bronze	6
3558EPBL	745.45	Matte Black	6
DROP ELL SOLD SEPARATELY			
A750	48.65	N/A or Unfinished	24















- showerhead functions: four-function
- showerhead type: eco-performance handshower
- showerhead size: 4-3/8" diameter spray head
- type of function: targeted massage; invigorating spray; full spray; combination
- flow rate: 1.75 gpm (6.65 L/min) max.
- hose length: 69"
- double check valve: included
- drop ell: sold separately



3636EP	265.90	Chrome	6
3636EPBN	618.05	Brushed Nickel	6
3636EPORB	618.05	Oil Rubbed Bronze	6

Handheld Showers













All Brushed Nickel, Polished Nickel, Polished Brass and Brushed Gold faucet components feature the Lifeshine® Non-Tarnish Finish.

		MODEL NUMBER	LIST PRICE	FINISH/ CONNECTION	CASE QTY	
HANDHELD [CONTINUED]						
	<ul style="list-style-type: none"> • showerhead functions: one-function • showerhead type: eco-performance showerhead • showerhead size: 2" diameter spray head • type of function: full spray • flow rate: 1.75 gpm (6.65 L/min) max. • hose length: 69" • wall bracket: included • double check valve: included • drop ell: sold separately 	3861EP	364.55	Chrome	6	
		3861EPBN	648.60	Brushed Nickel	6	
		3861EPNL	648.60	Polished Nickel	6	
		3861EPORB	648.60	Oil Rubbed Bronze	6	
	 					
	<ul style="list-style-type: none"> • showerhead functions: one-function • showerhead type: eco-performance handshower • showerhead size: 1-1/8" diameter spray head • type of function: full spray • flow rate: 1.75 gpm (6.65 L/min) max. • hose length: 69" • wall bracket: included • double check valve: included • drop ell: sold separately 	S11705EP	359.50	Chrome	6	
		S11705EPBN	658.00	Brushed Nickel	6	
	 					
	<ul style="list-style-type: none"> • showerhead functions: one-function • showerhead type: eco-performance handshower • showerhead size: 4" diameter spray head • type of function: full spray • flow rate: 1.75 gpm (6.65 L/min) max. • hose length: 59" • wall bracket: included • double check valve: included • drop ell: sold separately 	3865EP	216.70	Chrome	6	
		3865EPBN	353.70	Brushed Nickel	6	
		3865EPORB	353.70	Oil Rubbed Bronze	6	
	 					
	<ul style="list-style-type: none"> • showerhead functions: one-function • showerhead type: eco-performance handshower • showerhead size: 4-3/64" diameter spray head • type of function: full spray • flow rate: 1.75 gpm (6.65 L/min) max. • double check valve: included 	164929	97.20	Chrome	6	
		164929BN	152.35	Brushed Nickel	6	
		164929ORB	152.35	Oil Rubbed Bronze	6	
						
	<ul style="list-style-type: none"> • showerhead functions: four-function • showerhead type: eco-performance handshower • showerhead size: 4-3/8" diameter spray head • type of function: targeted massage; invigorating spray; full spray; combination • flow rate: 1.75 gpm (6.65 L/min) max. • double check valve: included 	164927	110.75	Chrome	6	
		164927BN	176.10	Brushed Nickel	6	
		164927ORB	176.10	Oil Rubbed Bronze	-	
						

CUSTOM SHOWERING





Handheld Showers

All Brushed Nickel, Polished Nickel, Polished Brass and Brushed Gold faucet components feature the Lifeshine® Non-Tarnish Finish.

		MODEL NUMBER	LIST PRICE	FINISH/ CONNECTION	CASE QTY
HANDHELD [CONTINUED]					
	<ul style="list-style-type: none"> • showerhead functions: one-function • showerhead type: eco-performance handshower • showerhead size: 1-1/8" diameter spray head • type of function: full spray • flow rate: 1.75 gpm (6.65 L/min) max. • double check valve: included 	155891	88.60	Chrome	6
		155891BN	133.85	Brushed Nickel	6
		155891BL	130.10	Matte Black	6
	<ul style="list-style-type: none"> • showerhead functions: one-function • showerhead type: eco-performance handshower • showerhead size: 1-1/8" diameter spray head • type of function: full spray • flow rate: 1.75 gpm (6.65 L/min) max. • double check valve: included  	189318	89.95	Chrome	6
		189318BN	130.55	Brushed Nickel	6
		189318ORB	130.55	Oil Rubbed Bronze	6
	<ul style="list-style-type: none"> • showerhead functions: five-function • showerhead type: eco-performance handshower • showerhead size: 4-3/8" diameter spray head • type of function: downpour; rinse; massage; relaxing massage; full spray • flow rate: 1.75 gpm (6.65 L/min) max. • double check valve: included  	189315	100.70	Chrome	6
		189315BN	153.55	Brushed Nickel	6
		189315ORB	153.55	Oil Rubbed Bronze	6
		189315BL	153.55	Matte Black	6
	<ul style="list-style-type: none"> • showerhead functions: one-function • showerhead type: eco-performance handshower • showerhead size: 3-3/8" diameter spray head • type of function: full spray • flow rate: 1.75 gpm (6.65 L/min) max. • double check valve: included 	154305	171.80	Chrome	6
		154305BN	251.50	Brushed Nickel	6
		154305NL	251.50	Polished Nickel	6
		154305ORB	251.50	Oil Rubbed Bronze	6
	<ul style="list-style-type: none"> • showerhead functions: three-function • showerhead type: eco-performance handshower • showerhead size: 4" diameter spray head • type of function: full spray; concentrated rinse; combination • flow rate: 1.75 gpm (6.65 L/min) max. • double check valve: included 	147913	148.30	Chrome	6
		147913BN	253.25	Brushed Nickel	6
	<ul style="list-style-type: none"> • showerhead functions: one-function • showerhead type: eco-performance handshower • showerhead size: 4-3/64" diameter spray head • type of function: full spray • flow rate: 1.75 gpm (6.65 L/min) max. • double check valve: included 	155747	97.20	Chrome	-
		155747BN	152.35	Brushed Nickel	-
		155747ORB	146.80	Oil Rubbed Bronze	6

Handheld Showers

All Brushed Nickel, Polished Nickel, Polished Brass and Brushed Gold faucet components feature the Lifeshine® Non-Tarnish Finish.

		MODEL NUMBER	LIST PRICE	FINISH/ CONNECTION	CASE QTY
HANDHELD [CONTINUED]					
	<ul style="list-style-type: none"> • showerhead functions: four-function • showerhead type: eco-performance handshower • showerhead size: 3-3/4" diameter spray head • type of function: targeted massage; invigorating spray; full spray; combination • flow rate: 1.75 gpm (6.65 L/min) max. • double check valve: included 	160042	163.15	Chrome	6
		160042BN	265.20	Brushed Nickel	6
		160042ORB	265.20	Oil Rubbed Bronze	6
	<ul style="list-style-type: none"> • showerhead functions: one-function • showerhead type: eco-performance handshower • showerhead size: 3" diameter spray head • type of function: full spray • flow rate: 1.75 gpm (6.65 L/min) max. • double check valve: included 	176257	105.80	Chrome	-
		176257BN	160.30	Brushed Nickel	6
	<ul style="list-style-type: none"> • showerhead functions: one-function • showerhead type: eco-performance handshower • showerhead size: 2" diameter spray head • type of function: full spray • flow rate: 1.75 gpm (6.65 L/min) max. • double check valve: included 	176015	142.05	Chrome	12
		176015BN	245.55	Brushed Nickel	12
		176015ORB	245.55	Oil Rubbed Bronze	12
		176015P	245.55	Polished Brass	12
		176015WR	245.55	Wrought Iron	12
	<ul style="list-style-type: none"> • showerhead functions: four-function • showerhead type: eco-performance handshower • showerhead size: 4-3/64" diameter spray head • type of function: targeted massage; invigorating spray; full spray; combination • flow rate: 1.75 gpm (6.65 L/min) max. • double check valve: included 	164928	108.70	Chrome	6
		164928BN	172.80	Brushed Nickel	6
		164928ORB	172.80	Oil Rubbed Bronze	-
		NEW! 164928BL*	172.80	Matte Black	6

CUSTOM SHOWERING

NOTES

*Ships Q2

Handheld Shower Accessories

All Brushed Nickel, Polished Nickel, Polished Brass and Brushed Gold faucet components feature the Lifeshine® Non-Tarnish Finish.

		MODEL NUMBER	LIST PRICE	FINISH/ CONNECTION	CASE QTY
DROP ELL					
	<ul style="list-style-type: none"> • connection size: 1/2" • connection type: IPS 	A721	71.15	Chrome	12
		A721BN	101.65	Brushed Nickel	12
		A721ORB	101.65	Oil Rubbed Bronze	12
		NEW! A721BG	101.65	Brushed Gold	12
	<ul style="list-style-type: none"> • connection size: 1/2" • connection type: IPS 	A725	63.00	Chrome	12
		A725BN	90.20	Brushed Nickel	12
		A725NL	90.20	Polished Nickel	12
		A725P	90.20	Polished Brass	12
		A725ORB	90.20	Oil Rubbed Bronze	12
		NEW! A725BG	90.20	Brushed Gold	12
SHOWER ARM DIVERTER					
	<ul style="list-style-type: none"> • connection size: 1/2" • connection type: IPS • type of function: two independent 1 shared • integral handshower cradle: included • metal construction • carded packaging 	CL707	132.40	Chrome	12
		CL707BN	202.70	Brushed Nickel	12
		CL707ORB	202.70	Oil Rubbed Bronze	12
	<ul style="list-style-type: none"> • connection size: 1/2" • connection type: IPS • type of function: two independent 1 shared • metal construction • carded packaging 	CL703	97.65	Chrome	12
		CL703BN	149.50	Brushed Nickel	12
		CL703ORB	149.50	Oil Rubbed Bronze	12
	<ul style="list-style-type: none"> • connection size: 1/2" • connection type: IPS • type of function: two discrete • metal construction 	A720	78.70	Chrome	12
		A720P	104.20	Polished Brass	12
		A720BN	104.20	Brushed Nickel	12
		A720ORB	104.20	Oil Rubbed Bronze	12
HANDSHOWER ARM CRADLE					
	<ul style="list-style-type: none"> • connection size: 1/2" • connection type: IPS • integral handshower cradle: included • metal construction: yes 	A701	54.80	Chrome	12
		A701BN	88.25	Brushed Nickel	12
		A701ORB	88.25	Oil Rubbed Bronze	12
HANDSHOWER WALL BRACKET					
	<ul style="list-style-type: none"> • integral handshower cradle: included 	155694	29.85	Chrome	12
		155694BN	45.25	Brushed Nickel	12
		155694ORB	45.25	Oil Rubbed Bronze	12
HANDSHOWER WALL BRACKET					
	<ul style="list-style-type: none"> • metal construction: yes • integral handshower cradle: included 	114348	77.75	Chrome	12
		114348ORB	125.40	Oil Rubbed Bronze	12
		114348WR	125.40	Wrought Iron	12
	<ul style="list-style-type: none"> • description: SecureMount anchors • use SecureMount anchor: to meet hand grip requirements 	A750	48.65		24

Body Sprays

All Brushed Nickel, Polished Nickel, Polished Brass and Brushed Gold faucet components feature the Lifeshine® Non-Tarnish Finish.

MOSAIC™ BODY SPRAY



- spray functions: one-function
- showerhead type: standard
- showerhead size: 5-3/8" diameter spray head
- valve sold separately (use S1300)
- flow rate: 2.0 gpm (7.6 L/min) max.
- 155656 1" extension kit available



TS1320	160.35	Chrome	6
TS1320BN	228.10	Brushed Nickel	6
TS1320NL	228.10	Polished Nickel	6
TS1320ORB	228.10	Oil Rubbed Bronze	6



- spray functions: one-function
- showerhead type: standard
- showerhead size: 5-3/8" diameter spray head
- valve sold separately (use S1300)
- flow rate: 2.0 gpm (7.6 L/min) max.
- 155656 1" extension kit available



TS1322	160.35	Chrome	6
TS1322BN	228.10	Brushed Nickel	6
TS1322NL	228.10	Polished Nickel	6
TS1322ORB	228.10	Oil Rubbed Bronze	6
NEW! TS1322BG	228.10	Brushed Gold	6
NEW! TS1322BL*	228.10	Matte Black	-



- spray functions: two-function
- showerhead type: standard
- showerhead size: 5-3/8" diameter spray head
- showerhead function: refreshing spray; targeted massage
- valve sold separately (use S1300)
- flow rate: 2.0 gpm (7.6 L/min) max.
- 155656 1" extension kit available



TS1420	256.60	Chrome	6
TS1420BN	353.50	Brushed Nickel	6
TS1420NL	353.50	Polished Nickel	6
TS1420ORB	353.50	Oil Rubbed Bronze	6



- spray functions: two-function
- showerhead type: standard
- showerhead size: 5-3/8" diameter spray head
- showerhead function: refreshing spray; targeted massage
- valve sold separately (use S1300)
- flow rate: 2.0 gpm (7.6 L/min) max.
- 155656 1" extension kit available



TS1422	256.60	Chrome	6
TS1422BN	353.50	Brushed Nickel	6
TS1422NL	353.50	Polished Nickel	6
TS1422ORB	353.50	Oil Rubbed Bronze	6
NEW! TS1422BG	353.50	Brushed Gold	6
NEW! TS1422BL*	353.50	Matte Black	-

BODY SPRAY VALVE ONLY



- installation: fits standard 2x4 wall

S1300	106.00	1/2" CC, IPS	6
--------------	--------	--------------	---

BODY SPRAY



- connection size: 1/2"
- connection type: IPS
- spray functions: one-function
- showerhead size: 2" diameter spray head
- flow rate: 1.75 gpm (6.65 L/min) max.



A501	114.70	Chrome	12
A501BN	154.60	Brushed Nickel	12
A501NL	154.60	Polished Nickel	12
A501P	154.60	Polished Brass	12
A501ORB	154.60	Oil Rubbed Bronze	12
A501WR	154.60	Wrought Iron	12

NOTES







Moen® **M•PACT**® Common Valve System

Immersion® Rainshower

*Ships Q2

Shower Arms and Flanges

All Brushed Nickel, Polished Nickel, Polished Brass and Brushed Gold faucet components feature the Lifeshine® Non-Tarnish Finish.





		MODEL NUMBER	LIST PRICE	FINISH/ CONNECTION	CASE QTY
SHOWER ARMS & FLANGES					
	<ul style="list-style-type: none"> • connection size: 1/2" • connection type: IPS • length: 14" 	S110	125.85	Chrome	6
		S110BN	155.25	Brushed Nickel	6
		S110BL	155.25	Matte Black	6
	<ul style="list-style-type: none"> • connection size: 1/2" • connection type: IPS • length: 14" 	S113	125.85	Chrome	6
		S113BN	155.25	Brushed Nickel	6
		S113NL	155.25	Polished Nickel	3
		S113ORB	155.25	Oil Rubbed Bronze	6
		S113WR	155.25	Wrought Iron	3
		NEW! S113BG	155.25	Brushed Gold	3
	<ul style="list-style-type: none"> • connection size: 1/2" • connection type: IPS • length: 8" 	161951	104.85	Chrome	12
		161951BN	138.10	Brushed Nickel	12
		161951ORB	138.10	Oil Rubbed Bronze	12
		NEW! 161951BG	138.10	Brushed Gold	12
		NEW! 161951NL*	138.10	Polished Nickel	12
		NEW! 161951BL*	138.10	Matte Black	12
	<ul style="list-style-type: none"> • connection size: 1/2" • connection type: IPS • length: 16" 	151380	76.40	Chrome	6
		151380BN	131.00	Brushed Nickel	6
		151380ORB	131.00	Oil Rubbed Bronze	6
	<ul style="list-style-type: none"> • connection size: 1/2" • connection type: IPS • length: 8" 	S122	50.85	Chrome	6
		S122BN	96.75	Brushed Nickel	6
		S122ORB	96.75	Oil Rubbed Bronze	6
	<ul style="list-style-type: none"> • connection size: 1/2" • connection type: IPS • length: 12" 	226651	51.40	Chrome	6
		226651BN	93.30	Brushed Nickel	6
		226651NL	93.30	Polished Nickel	6
		226651ORB	93.30	Oil Rubbed Bronze	6
		226651WR	93.30	Wrought Iron	6
		NEW! 226651BG	93.30	Brushed Gold	6

NOTES

*Ships Q2

Shower Arms and Flanges







All Brushed Nickel, Polished Nickel, Polished Brass and Brushed Gold faucet components feature the Lifeshine® Non-Tarnish Finish.

		MODEL NUMBER	LIST PRICE	FINISH/ CONNECTION	CASE QTY
SHOWER ARMS & FLANGES [CONTINUED]					
 <ul style="list-style-type: none"> • connection size: 1/2" • connection type: IPS • length: 6" 		116651	20.05	Chrome	6
		116651BN	32.95	Brushed Nickel	6
		116651NL	32.95	Polished Nickel	6
		116651WR	32.95	Wrought Iron	6
		116651ORB	32.95	Oil Rubbed Bronze	6
 <ul style="list-style-type: none"> • connection size: 1/2" • connection type: IPS • length: 6" 		123815	28.65	Chrome	12
		123815BN	63.45	Brushed Nickel	12
		123815ORB	63.45	Oil Rubbed Bronze	12
		NEW! 123815BG	63.45	Brushed Gold	12
		NEW! 123815BL	63.45	Matte Black	12
 <ul style="list-style-type: none"> • connection size: 1/2" • connection type: IPS • length: 6" 		10154	12.80	Chrome	50
		10154BN	32.85	Brushed Nickel	50
		10154NL	32.85	Polished Nickel	0
		10154WR	32.85	Wrought Iron	20
		10154ORB	32.85	Oil Rubbed Bronze	50
		10154P	32.85	Polished Brass	0
		10154SLP	32.85	Brushed Platinum	20
		NEW! 10154BG	32.85	Brushed Gold	30
 <ul style="list-style-type: none"> • shower arm flange 		164745	14.00	Chrome	20
		164745BN	31.60	Brushed Nickel	20
		164745ORB	31.60	Oil Rubbed Bronze	20
		NEW! 164745BG	31.60	Brushed Gold	20
 <ul style="list-style-type: none"> • shower arm flange 		AT2199	11.50	Chrome	200
		AT2199SLP	18.55	Brushed Platinum	24
		AT2199BN	30.55	Brushed Nickel	200
		AT2199NL	30.55	Polished Nickel	48
		AT2199P	30.55	Polished Brass	48
		AT2199ORB	30.55	Oil Rubbed Bronze	200
		AT2199WR	30.55	Wrought Iron	12
 <ul style="list-style-type: none"> • shower accent kit 		AT2099	36.70	Chrome	12
		AT2099BN	51.25	Brushed Nickel	12
		AT2099P	51.25	Polished Brass	12
		AT2099ORB	51.25	Oil Rubbed Bronze	12

CUSTOM SHOWERING

Showering Accessories

All Brushed Nickel, Polished Nickel, Polished Brass and Brushed Gold faucet components feature the Lifeshine® Non-Tarnish Finish.

		MODEL NUMBER	LIST PRICE	FINISH/ CONNECTION	CASE QTY
REPLACEMENT SLIDE BAR					
	<ul style="list-style-type: none"> slide bar length: 24" slide bar: not to be used as a grab bar use SecureMount anchor: to meet hand grip requirements 	155746	218.90	Chrome	6
		155746BN	320.50	Brushed Nickel	-
		155746ORB	320.50	Oil Rubbed Bronze	6
	<ul style="list-style-type: none"> slide bar length: 30" slide bar: not to be used as a grab bar use SecureMount anchor: to meet hand grip requirements 	A735	268.00	Chrome	6
		A735BN	402.55	Brushed Nickel	6
		A735ORB	402.55	Oil Rubbed Bronze	6
		A735P	402.55	Polished Brass	6
		A735WR	402.55	Wrought Iron	6
	<ul style="list-style-type: none"> use SecureMount anchor: to meet hand grip requirements 	A750	48.65		24
HANDSHOWER HOSE					
	<ul style="list-style-type: none"> connection size: 1/2" connection type: IPS hose length: 80" metal construction: yes 	A780	133.40	Chrome	20
	<ul style="list-style-type: none"> connection size: 1/2" connection type: IPS hose length: 69" metal construction: yes 	A726	92.40	Chrome	12
		A726WR	202.25	Wrought Iron	6
		A726NL	202.25	Polished Nickel	24
		A726P	202.25	Polished Brass	24
		A726ST	202.25	Satine	12
		A726BR	202.25	Brown	12
		A726BG	202.25	Brushed Gold	12
	<ul style="list-style-type: none"> connection size: 1/2" connection type: IPS hose length: 59" metal construction: yes 	155748	78.20	Chrome	-
		155748BN	164.80	Brushed Nickel	-
SHOWER VACUUM BREAKER					
	<ul style="list-style-type: none"> connection size: 1/2" connection type: IPS 	A714	88.10	Chrome	24
		A714ST	106.25	Satine	24

CUSTOM SHOWERING

Diverter Tub Spouts

All Brushed Nickel, Polished Nickel, Polished Brass and Brushed Gold faucet components feature the Lifeshine® Non-Tarnish Finish.

DIVERTER TUB SPOUTS		MODEL NUMBER	LIST PRICE	FINISH/ CONNECTION	CASE QTY
 <ul style="list-style-type: none"> • connection size: 1/2" • connection type: slip fit • spout length: 6 3/4" • tub spout type: diverter 		S12104	143.80	Chrome	6
		S12104BN	235.30	Brushed Nickel	6
		S12104ORB	235.30	Oil Rubbed Bronze	6
		NEW! S12104BG	235.30	Brushed Gold	6
		NEW! S12104BL*	235.30	Matte Black	-
 <ul style="list-style-type: none"> • connection size: 1/2" • connection type: slip fit • spout length: 6 3/4" • tub spout type: diverter 		S114	136.60	Chrome	6
		S114BN	223.55	Brushed Nickel	6
		S114ORB	223.55	Oil Rubbed Bronze	6
 <ul style="list-style-type: none"> • connection size: 1/2" • connection type: slip fit • spout length: 7 5/8" • tub spout type: diverter 		S3859	116.55	Chrome	6
		S3859BN	182.15	Brushed Nickel	6
		S3859ORB	182.15	Oil Rubbed Bronze	6
 <ul style="list-style-type: none"> • connection size: 1/2" • connection type: slip fit • spout length: 7 1/4" • tub spout type: diverter 		S3900	120.70	Chrome	6
 <ul style="list-style-type: none"> • connection size: 1/2" • connection type: slip fit • spout length: 7 1/4" • tub spout type: diverter 		S3896	117.50	Chrome	6
		S3896BN	185.20	Brushed Nickel	6
 <ul style="list-style-type: none"> • connection size: 1/2" • connection type: slip fit • spout length: 7 3/4" • tub spout type: diverter 	NEW!	S3835	131.75	Chrome	6
		S3835BN	214.50	Brushed Nickel	6
		S3835BL	214.50	Matte Black	6
 <ul style="list-style-type: none"> • connection size: 1/2" • connection type: slip fit • spout length: 7 1/4" • tub spout type: diverter 		S3840	99.40	Chrome	6
		S3840BN	143.10	Brushed Nickel	6







CUSTOM SHOWERING

NOTES

*Ships Q2

Diverter Tub Spouts

All Brushed Nickel, Polished Nickel, Polished Brass and Brushed Gold faucet components feature the Lifeshine® Non-Tarnish Finish.





		MODEL NUMBER	LIST PRICE	FINISH/ CONNECTION	CASE QTY
DIVERTER TUB SPOUTS [CONTINUED]					
	<ul style="list-style-type: none"> • connection size: 1/2" • connection type: slip fit • spout length: 5" • tub spout type: diverter 	3807	94.40	Chrome	12
		3807CP	106.75	Chrome/Polished Brass	12
		3807BN	140.90	Brushed Nickel	12
	<ul style="list-style-type: none"> • connection size: 1/2" • connection type: slip fit • spout length: 7 1/4" • tub spout type: diverter 	3857	86.00	Chrome	6
		3857BN	139.25	Brushed Nickel	6
		3857ORB	139.25	Oil Rubbed Bronze	6
	<ul style="list-style-type: none"> • connection size: 1/2" • connection type: IPS • spout length: 5" • tub spout type: diverter 	3806	95.55	Chrome	12
	<ul style="list-style-type: none"> • connection size: 1/2" • connection type: slip fit • spout length: 7 3/4" • tub spout type: diverter 	161955	101.65	Chrome	6
		161955BN	145.45	Brushed Nickel	6
		161955ORB	145.45	Oil Rubbed Bronze	6
		NEW! 161955BG	145.45	Brushed Gold	6
		NEW! 161955NL*	145.45	Polished Nickel	6
	<ul style="list-style-type: none"> • connection size: 1/2" • connection type: slip fit • spout length: 5 1/2" • tub spout type: diverter 	3803P	168.40	Polished Brass	12
	<ul style="list-style-type: none"> • connection size: 1/2" • connection type: IPS • spout length: 5 1/2" • tub spout type: diverter 	3809BN	110.10	Brushed Nickel	12
	<ul style="list-style-type: none"> • connection size: 1/2" • connection type: CC • spout length: 6 1/2" • tub spout type: diverter 	3890	94.40	Chrome	12
		3890BN	135.85	Brushed Nickel	12

NOTES

*Ships Q2

Diverter Tub Spouts







All Brushed Nickel, Polished Nickel, Polished Brass and Brushed Gold faucet components feature the Lifeshine® Non-Tarnish Finish.

DIVERTER TUB SPOUTS [CONTINUED]		MODEL NUMBER	LIST PRICE	FINISH/ CONNECTION	CASE QTY
 <ul style="list-style-type: none"> • connection size: 1/2" • connection type: slip fit • spout length: 7 15/16" • tub spout type: diverter 		175385	103.25	Chrome	6
		175385BN	148.75	Brushed Nickel	6
		175385NL	148.75	Polished Nickel	6
		175385ORB	148.75	Oil Rubbed Bronze	6
 <ul style="list-style-type: none"> • connection size: 1/2" • connection type: slip fit • spout length: 5 1/2" • tub spout type: diverter 		3808	77.10	Chrome	12
		3808BN	132.55	Brushed Nickel	12
		3808P	140.90	Polished Brass	12
		3808ORB	127.75	Oil Rubbed Bronze	12
		3808WR	132.55	Wrought Iron	12
 <ul style="list-style-type: none"> • connection size: 1/2" • connection type: IPS • spout length: 5 1/2" • tub spout type: diverter 		3800	58.50	Chrome	12
 <ul style="list-style-type: none"> • connection size: 1/2" • connection type: IPS • spout length: 5 1/2" • tub spout type: diverter 		3801	59.85	Chrome	12
 <ul style="list-style-type: none"> • connection size: 1/2" • connection type: slip fit • spout length: 5 7/8" • tub spout type: diverter 		152027	72.05	Chrome	12
		152027BN	114.55	Brushed Nickel	12
 <ul style="list-style-type: none"> • connection size: 1/2" • connection type: slip fit • spout length: 5 1/2" • tub spout type: diverter 		3929BC	94.75	Brushed Chrome	12
 <ul style="list-style-type: none"> • connection size: 1/2" • connection type: slip fit • spout length: 7 1/8" • tub spout type: diverter 		172656	100.45	Chrome	6
		172656BN	132.85	Brushed Nickel	6
		172656BL	129.15	Matte Black	6
		NEW! 172656BG	129.15	Brushed Gold	6

CUSTOM SHOWERING











Diverter Tub Spouts

All Brushed Nickel, Polished Nickel, Polished Brass and Brushed Gold faucet components feature the Lifeshine® Non-Tarnish Finish.

		MODEL NUMBER	LIST PRICE	FINISH/ CONNECTION	CASE QTY
DIVERTER TUB SPOUTS [CONTINUED]					
	<ul style="list-style-type: none"> • connection size: 1/2" • connection type: slip fit • spout length: 7" • tub spout type: diverter 	3839	72.65	Chrome	12
		3839BN	127.80	Brushed Nickel	1
	<ul style="list-style-type: none"> • connection size: 1/2" • connection type: IPS • spout length: 5 1/2" • tub spout type: diverter 	3911	61.30	Chrome	12
	<ul style="list-style-type: none"> • connection size: 1/2" • connection type: slip fit • spout length: 5 1/2" • tub spout type: diverter 	3960	64.55	Chrome	12
	<ul style="list-style-type: none"> • connection size: 1/2" • connection type: slip fit • spout length: 7" • tub spout type: diverter 	3853	72.65	Chrome	12
		3853BN	127.80	Brushed Nickel	12
		3853ORB	127.80	Oil Rubbed Bronze	12
	<ul style="list-style-type: none"> • connection size: 1/2" • connection type: slip fit • spout length: 5 1/2" • tub spout type: diverter 	3931	37.30	Chrome	12
	<ul style="list-style-type: none"> • connection size: 1/2" • connection type: IPS • spout length: 5 1/2" • tub spout type: diverter 	3926	52.05	Chrome	12

Non-Diverter Tub Spouts

All Brushed Nickel, Polished Nickel, Polished Brass and Brushed Gold faucet components feature the Lifeshine® Non-Tarnish Finish.

NON-DIVERTER TUB SPOUTS		MODEL NUMBER	LIST PRICE	FINISH/ CONNECTION	CASE QTY
 <ul style="list-style-type: none"> • connection size: 1/2" • connection type: slip fit • spout length: 6 3/4" • tub spout type: non diverter 		S12105	136.05	Chrome	6
		S12105BN	226.35	Brushed Nickel	6
		S12105NL	226.35	Polished Nickel	6
		S12105ORB	226.35	Oil Rubbed Bronze	6
		NEW! S12105BL*	226.35	Matte Black	-
 <ul style="list-style-type: none"> • connection size: 1/2" • connection type: slip fit • spout length: 7 1/8" • tub spout type: non diverter 		S16900	132.30	Chrome	6
		S16900BN	220.50	Brushed Nickel	6
		NEW! S16900BL*	220.50	Matte Black	-
 <ul style="list-style-type: none"> • connection size: 1/2" • connection type: slip fit • spout length: 7 1/8" • tub spout type: non diverter 		S3901	114.05	Chrome	6
 <ul style="list-style-type: none"> • connection size: 1/2" • connection type: slip fit • spout length: 7-3/4" • tub spout type: non diverter 	NEW!	S3836	120.70	Chrome	6
		S3836BN	203.40	Brushed Nickel	6
		S3836BL	203.40	Matte Black	6
 <ul style="list-style-type: none"> • connection size: 1/2" • connection type: slip fit • spout length: 7 5/8" • tub spout type: non diverter 		S3860	112.75	Chrome	6
		S3860BN	174.75	Brushed Nickel	6
		S3860ORB	174.75	Oil Rubbed Bronze	6
 <ul style="list-style-type: none"> • connection size: 1/2" • connection type: slip fit • spout length: 7 1/4" • tub spout type: non diverter 		S3898	109.50	Chrome	6
		S3898BN	177.65	Brushed Nickel	6
 <ul style="list-style-type: none"> • connection size: 1/2" • connection type: slip fit • spout length: 7 1/4" • tub spout type: non diverter 		S3842	91.70	Chrome	6
		S3842BN	126.85	Brushed Nickel	6
 <ul style="list-style-type: none"> • connection size: 1/2" • connection type: slip fit • spout length: 7 1/4" • tub spout type: non diverter 		3858	82.25	Chrome	6
		3858BN	126.75	Brushed Nickel	6
		3858ORB	126.75	Oil Rubbed Bronze	6
 <ul style="list-style-type: none"> • connection size: 1/2" • connection type: slip fit • spout length: 7 3/4" • tub spout type: non diverter 		191956	95.10	Chrome	6
		191956BN	136.80	Brushed Nickel	6
		191956ORB	136.80	Oil Rubbed Bronze	6
 <ul style="list-style-type: none"> • connection size: 1/2" • connection type: slip fit • spout length: 7 15/16" • tub spout type: non diverter 		195386	93.90	Chrome	6
		195386BN	135.90	Brushed Nickel	6
		195386NL	135.90	Polished Nickel	6
		195386ORB	135.90	Oil Rubbed Bronze	6
		NEW! 195386NL*	135.90	Polished Nickel	6









CUSTOM SHOWERING

NOTES

*Ships Q2

Non-Diverter Tub Spouts

All Brushed Nickel, Polished Nickel, Polished Brass and Brushed Gold faucet components feature the Lifeshine® Non-Tarnish Finish.



		MODEL NUMBER	LIST PRICE	FINISH/ CONNECTION	CASE QTY
NON-DIVERTER TUB SPOUTS [CONTINUED]					
	<ul style="list-style-type: none"> connection size: 1/2" connection type: slip fit spout length: 6 1/2" tub spout type: non diverter 	3892	87.05	Chrome	12
		3892BN	124.80	Brushed Nickel	12
		NEW! 3892BG	124.80	Brushed Gold	6
	<ul style="list-style-type: none"> connection size: 1/2" connection type: slip fit spout length: 5 1/2" tub spout type: non diverter 	3959	55.60	Chrome	12
	<ul style="list-style-type: none"> connection size: 1/2" connection type: IPS spout length: 7" tub spout type: non diverter 	3828	58.85	Chrome	12
	<ul style="list-style-type: none"> connection size: 1/2" connection type: slip fit spout length: 7" tub spout type: non diverter 	3829	58.85	Chrome	12
		3829BC	98.25	Brushed Chrome	12
		3829BN	142.20	Brushed Nickel	12
		3829ORB	142.20	Oil Rubbed Bronze	12
	<ul style="list-style-type: none"> connection size: 1/2" connection type: IPS spout length: 5" tub spout type: non diverter 	3804	46.65	Chrome	12
	<ul style="list-style-type: none"> connection size: 1/2" connection type: slip fit spout length: 5" tub spout type: non diverter 	3805	46.65	Chrome	12
TUBING					
	<ul style="list-style-type: none"> top & bottom ells thread size: 1-1/2" 	140680	17.65	SCH 40 ABS	12
	<ul style="list-style-type: none"> connection size: 1 1/2" connection type: male IPS; threaded shoe 	T90331	37.05	Chrome	12
		T90331BN	119.25	Brushed Nickel	12
		NEW! T90331BG	119.25	Brushed Gold	12
		T90331NL	119.25	Polished Nickel	12
		T90331ORB	119.25	Oil Rubbed Bronze	12
		T90331P	119.25	Polished Brass	12
		T90331WR	119.25	Wrought Iron	12
HARDWARE KIT					
	<ul style="list-style-type: none"> conversion bar kit converts 2-hole top ell to accommodate 1-hole face plate 	142538	6.20		180

NOTES

 Moen® **M•PACT**® System.

Bath Tub Drains

All Brushed Nickel, Polished Nickel, Polished Brass and Brushed Gold faucet components feature the Lifeshine® Non-Tarnish Finish.

SHOWER DRAIN COVERS		MODEL NUMBER	LIST PRICE	FINISH/ CONNECTION	CASE QTY
 <ul style="list-style-type: none"> • drain size: fits 3" diameter drain 		101663BN	45.25	Brushed Nickel	12
		101663ORB	44.85	Oil Rubbed Bronze	12
		NEW! 101663BG	45.25	Brushed Gold	12
		101663WR	46.10	Wrought Iron	12
 <ul style="list-style-type: none"> • drain size: mounts on 2-5/8" centres 		101664BN	48.80	Brushed Nickel	12
		101664ORB	47.00	Oil Rubbed Bronze	12
		NEW! 101664BG	47.00	Brushed Gold	12
		101664WR	47.00	Wrought Iron	12





Coordinating Bath Accessories



Kyvos™ Bath Accessories / BP3703CH / BP3708CH / BP3718CH / BP3786CH

Curved Shower Rods

All Brushed Nickel faucet components feature the Lifeshine® Non-Tarnish Finish.

	MODEL NUMBER	LIST PRICE	FINISH/ CONNECTION	CASE QTY
ADJUSTABLE LENGTH DECORATIVE CURVED SHOWER ROD WITH PIVOTING FLANGES				
WHOLESALE PACKAGING				
	• 6' - adjustable length - 54" - 72"	CSR2160CH	61.05 Chrome	10
		CSR2160BN	67.10 Brushed Nickel	10
		CSR2160WB	76.65 Old World Bronze	10
		CSR2160BG	67.10 Brushed Gold	10
RETAIL PACKAGING				
	• 6' - adjustable length - 54" - 72"	DN2160CH	67.45 Chrome	3
		DN2160BN	74.15 Brushed Nickel	3
		DN2160WB	84.85 Old World Bronze	3
FIXED-LENGTH DECORATIVE CURVED SHOWER ROD WITH PIVOTING FLANGES				
WHOLESALE PACKAGING				
	• 5' - fixed length - pivoting flanges	CSR2165CH	48.05 Chrome	10
		CSR2165BN	52.85 Brushed Nickel	10
		CSR2165WB	60.85 Old World Bronze	10
	• 6' - fixed length - pivoting flanges	CSR2166CH	55.30 Chrome	10
		CSR2166BN	60.75 Brushed Nickel	10
	• 5' - fixed length - non-pivoting flanges*	CSR2155CH	47.20 Chrome	10
	CSR2155BN	52.55 Brushed Nickel	10	
	CSR2155WB	59.05 Old World Bronze	10	
CURVED SHOWER RODS WITH NON-PIVOTING FLANGES - LOW PROFILE*				
WHOLESALE PACKAGING				
	• 5' - curved shower rod only*	2-102-5PS	24.35 Chrome	25
	• Low-profile flange kit only*	65-F-PS	17.95 Chrome	25
	• 5' - curved shower rod only*	2-102-5BS	26.80 Brushed Nickel	25
	• Low-profile flange kit only*	65-F-BS	19.85 Brushed Nickel	25
* For a complete wholesale curved shower shower rod unit, order both the curved shower rod and low-profile flange kit.				
• 5' - complete - non-pivoting flanges	CSR2145CH	44.30 Chrome	10	
	CSR2145BN	50.55 Brushed Nickel	10	
DOUBLE CURVED SHOWER RODS				
	• Adjustable length - 57" - 60"	DN2141CH	82.45 Chrome	2
		DN2141BN	85.35 Brushed Nickel	2
		DN2141WB	99.40 Old World Bronze	2

The SecureMount™ System

Install Grab Bars Anywhere on the Wall!

SecureMount Grab Bars and SecureMount Anchors make it possible to quickly and easily install a grab bar with or without studs.

Did you know:

- 16" grab bars can mount directly into studs because the standard stud size is 16" on center.
- 18", 24", 36", and 42" grab bars will often need an anchoring system when mounted into drywall, as an alternative to stud or wood block installation.

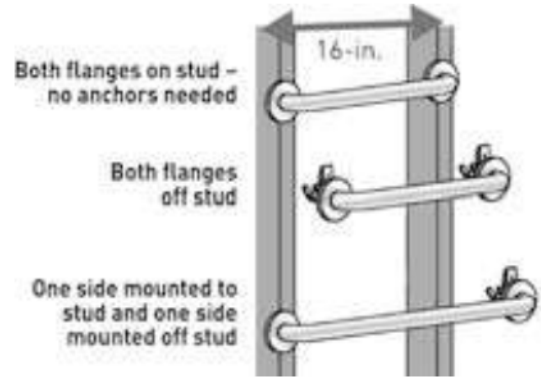

The SecureMount System—Easy, Secure Install ... Anywhere on the Wall!™



SecureMount Grab Bars

The unique flange makes it easy to connect to the stud at multiple points, at any angle!

SecureMount Anchors

Precision engineered for optimal bracing behind the wall, SecureMount Anchors allow for easy grab bar installation — with no studs required — anywhere on the wall.

SecureMount System

The SecureMount System is the ultimate in easy, secure grab bar installation. Plus it provides stylish designs and choices in finishes and features.

SecureMount Anchors Are Versatile.

Installs anywhere on the wall and can be used with all Moen and virtually all other grab bars. Mount securely to a variety of substrates*:

- 1/2" Drywall
- 1/2" Drywall with tile
- 1/2" Drywall with marble
- 1/8" Fiberglass tub surround
- 1/4" Fiberglass tub surround
- 5/8" Drywall
- 5/8" Drywall with tile
- 5/8" Drywall with marble

*Including multiple layers up to 1 1/2" thick



COORDINATING ACCESSORIES

300 lb. weight capacity when securely installed per instructions. Limited Lifetime Warranty. Independently tested by CSA and NAHB laboratories to exceed ADA, ASTM, ANSI and CSA standards.

MOEN® Bath Safety

GRAB BARS WITH ACCESSORIES



SecureMount™ Grab Bars are manufactured with an innovative flange design that makes it easy to connect to the stud at multiple points.

To install grab bars securely without studs, use SecureMount™ Anchors.

MODEL NUMBER	LIST PRICE EACH	DESCRIPTION	QTY
Chrome (CH)			
LR2350DCH	61.65	24" Grab Bar With Towel Bar	3
LR2352DCH	61.65	8" Grab Bar With Paper Holder	3
LR2354DCH	61.65	9" Grab Bar With Corner Shelf	3
LR2356DCH	61.65	16" Grab Bar With Shelf	3
Brushed Nickel (BN)			
LR2350DBN	61.65	24" Grab Bar With Towel Bar	3
LR2352DBN	61.65	8" Grab Bar With Paper Holder	3
LR2354DBN	61.65	9" Grab Bar With Corner Shelf	3
LR2356DBN	61.65	16" Grab Bar With Shelf	3
Old World Bronze			
LR2350DOWB	73.75	24" Grab Bar With Towel Bar	3
LR2352DOWB	73.75	8" Grab Bar With Paper Holder	3
LR2354DOWB	73.75	9" Grab Bar With Corner Shelf	3
LR2356DOWB	73.75	16" Grab Bar With Shelf	3



LR2350D
24" Grab Bar With Towel Bar



LR2352D
8" Grab Bar With Paper Holder



LR2354D
9" Grab Bar With Corner Shelf



LR2356D
16" Grab Bar With Shelf

SECUREMOUNT™

MODEL NUMBER	LIST PRICE EACH	DESCRIPTION	QTY
Chrome (CH)			
SMA1000CH	48.80	SecureMount™ Anchor 1 Pair	24
SMA1001CH	43.55	SecureMount™ Anchor 10 Pairs	10
Oil Rubbed Bronze (ORB)			
SMA1000OWB	48.80	SecureMount™ Anchor 1 Pair	24



SMA1000 & SMA1001
SecureMount™ Anchor

COORDINATING ACCESSORIES



Complies with Americans with Disabilities Act (ADA) specifications. SecureMount™ Grab Bars are tested to withstand 226 kg (500 lbs) pull when securely installed per instructions.

List price is per each (unless otherwise noted). Product can be ordered by case quantity or individually.



BATH SAFETY FURNITURE

MODEL NUMBER	LIST PRICE EACH	DESCRIPTION	QTY
Glacier			
DN7025	75.70	Showers Seat	2
DN7065	173.40	Transfer Bench	1
Stainless			
DN7110	480.65	Teak Folding Shower Seat	2



DN7025
Adjustable Shower Seat



DN7110
Teak Folding Shower Seat



DN7065
Tool-Free Transfer Bench







**COORDINATING
ACCESSORIES**



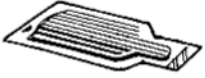





Moen Genuine Replacement Parts













Moen Genuine Parts Display

		MODEL NUMBER	LIST PRICE	DESCRIPTION	CASE QTY
REPLACEMENT CARTRIDGES					
	Single-handle replacement cartridge, brass	1200®	52.20	Carded	36
	Single-handle replacement cartridge, brass, order in multiples of 12	1200®B	51.95	Bulk (12 pcs.)	144
	Single-handle replacement cartridge	1225®	42.40	Carded	36
	Single-handle replacement cartridge, order in multiples of 12	1225®B	40.65	Bulk (12 pcs.)	144
	Two-handle replacement cartridge (hot or cold)	1224®	22.35	Carded	36
	Two-handle replacement cartridge (hot or cold), order in multiples of 12	1224®B	20.60	Bulk (12 pcs.)	144
	Two-handle replacement cartridge, for 4997 valve prior to 6/00	14891	20.75	-	60
	Two-handle replacement cartridge for high flow Roman tubs, order in multiples of 12	1248®	22.35	Carded	18
		1248®B	20.75	Bulk (12 pcs.)	144
	Two-handle Duralast® cartridge	1234	20.60	Carded	1
		1258	20.60	Carded	18
	Single-handle replacement cartridge, Posi-Temp®	1222	117.60	Carded	18
	Single-handle replacement cartridge, Posi-Temp®, order in multiples of 6 • repair kit 96988	1222B	114.90	Bulk (6 pcs.)	72
	Single-handle Duralast® cartridge, a revolutionary ceramic disc design that provides like-new operation for generations of use • includes plastic retaining nut	1255®	40.65	Carded	72
	Single-handle Duralast® cartridge with brass retaining nut for 90°™	150257	48.30	-	50
	Single-handle replacement cartridge, ceramic disc • for 6100 series	121620	40.15	-	24
	Thermostatic cartridge • for S3371 valve	147208	274.65	-	12









		MODEL NUMBER	LIST PRICE	DESCRIPTION	CASE QTY
CARTRIDGE REPAIR KIT					
	Cartridge repair kit for 1222/1222B Posi-Temp® single-handle tub/shower	96988	22.80	-	100
	Moen® silicone oil for Posi-Temp® balancing spools	140676	6.45	-	96
	Moen® silicone grease for cartridges and o-rings	99915	7.15	-	2500
CARTRIDGE RETAINER CLIPS					
	Retainer clips for 1200 and 1225 single-handle cartridges	96365	4.40	Carded	36
	Retainer clips for Posi-Temp® single-handle tub/shower	96914	6.80	-	500
TOOLS					
	Cartridge retainer removal tool for 1224, 1248 two-handle cartridge	14272	7.25	-	150
	Installation tool for Roman tub valves (4792, 4793, 4992, 4993) with adjustable shank	150313	10.80	-	12
	Installation tool, all metal	100110	16.20	-	1
	Installation tool, non-metallic • for widespreads and single-mount lavs and kitchens	118305	14.50	-	100
O-RING KIT					
	Spout o-ring kit	96778	10.55	Carded	36
	Order in multiples of 12	117	7.05	Bulk	72

		MODEL NUMBER	LIST PRICE	DESCRIPTION	CASE QTY
REPLACEMENT HANDLES AND CAPS					
	Handle kit, Chateau® single-handle lav, clear knob with cap	96791	33.55	-	150
	Handle kit, Chateau® single-handle tub/shower, clear knob with cap	96797	33.55	-	150
	Handle kit, Chateau® single-handle lav with Duralast™	150627	33.55	-	50
	Handle insert kit, Chateau® single-handle lav, non-pressure-balancing shower, with cap	91751	12.75	-	1000
	Handle kit, Posi-Temp® single-handle tub/shower with cap	100710	23.10	Carded	18
	Handle kit, less cap , Posi-Temp® single-handle tub/shower	94514	13.55	-	150
	Lever handle cap, Chateau® single-handle kitchen	96790	33.55	Chrome	1
	Lever handle, Chateau® single-handle kitchen	10927	46.90	Chrome	30
	Handle caps, Chateau® two-handle lav, kitchen, bar, and tub/shower	13382	12.50	-	300







		MODEL NUMBER	LIST PRICE	DESCRIPTION	CASE QTY
ECO-PERFORMANCE AERATOR INSERTS					
	Aerator flow restrictor, 1.5 gpm (5.7 L/min) max. • aerated flow • fits Chateau®, Castleby®, Villeta® Eva®, Brantford™, Level®, Monticello®, Kingsley®, Waterhill® and Vestige® lavatory or kitchen faucets	116711	8.05	-	500
	Aerator flow restrictor, 1.0 gpm (3.8 L/min) max. • aerated flow • fits Chateau®, Castleby®, Villeta®, Eva®, Brantford™, Level®, Monticello®, Kingsley®, Waterhill® and Vestige® lavatory or kitchen faucets	216721	8.10	-	700
	Aerator flow restrictor, 1.5 gpm (5.7 L/min) max. • laminar flow • for use on all Solace® lavatory faucets	216711	8.10	-	200
	Aerator flow restrictor, 1.5 gpm (5.7 L/min) max. • laminar flow • for use on all Icon™ and Divine® lavatory faucets	316711	8.10	-	350
	Aerator flow restrictor, 0.5 gpm (1.9 L/min) max. • laminar flow • for use on Arris™, Align™ and Icon™ lavatory faucets	175083	8.10	-	200
	Aerator flow restrictor, 1.0 gpm (3.8 L/min) max. • laminar flow • for use on Arris™, Align™ and Icon™ lavatory faucets	175084	8.10	-	350
	Aerator flow restrictor, 1.5 gpm (5.7 L/min) max. • laminar flow • for use on Felicity®, Savvy®, Organic™, Waterhill® and Tres Chic™ lavatory faucets	416711	8.10	-	200
	Aerator flow restrictor, 0.5 gpm (1.9 L/min) max. • rosetta spray • fits Chateau®, Castleby®, Villeta®, Eva®, Brantford™, Level®, Monticello®, Kingsley®, and Vestige® lavatory or kitchen faucets	516711	8.10	-	500
	Aerator flow restrictor, 0.5 gpm (1.9 L/min) max. • vandal proof • fits Chateau® lavs • removal tool included	52016	21.95	-	-
	Aerator flow restrictor, 1.5 gpm (5.7 L/min) max. • aerated flow • fits Weymouth® lavatory faucets	154289	9.80	-	20
	Aerator Jr., 0.5 gpm (1.9 L/min) max. • aerated flow • fits Rothbury™ wall mount, Eva® and Brantford™ single-handle, and Method® lavatory faucets	154364	8.10	-	100

		MODEL NUMBER	LIST PRICE	DESCRIPTION	CASE QTY
ECO-PERFORMANCE AERATOR INSERTS (CONTINUED)					
	Aerator flow restrictor, 1.0 gpm (3.8 L/min) max. • aerated flow • fits Rothbury™ wall mount, Eva® and Brantford™ single-handle, and Method® lavatory faucets	163847	8.10	-	100
	Aerator flow restrictor, 1.5 gpm (5.7 L/min) max. • aerated flow • fits Rothbury™ wall mount, Eva® and Brantford™ single-handle, and Method® lavatory faucets	143326	15.25	-	100
	Aerator flow restrictor, 0.5 gpm (1.9 L/min) max. • aerated flow • fits Rothbury™ single-handle, two-handle and widespreads, and Voss™ lavatory faucets	165018	8.10	-	12
	Aerator flow restrictor, 1.5 gpm (5.7 L/min) max. • aerated flow • fits Rothbury™ single-handle, two-handle and widespreads, and Voss™ lavatory faucets	137401	15.70	-	12
AERATORS					
	Aerator, 2.2 gpm (8.3 L/min) max., male thread	3919	16.70	Chrome (Carded)	18
	Aerator, 2.2 gpm (8.3 L/min) max., female thread	3924	16.70	Chrome (Carded)	18
SWIVEL-SPRAY AERATORS					
	Aerator, Swing-n-Spray®, 2.2 gpm (8.3 L/min) max.	20200	43.10	Chrome (Carded)	18
PULLOUT/PULLDOWN HOSE MANAGEMENT SYSTEM					
	Pullout/pulldown hose management system • system helps prevent hose and weight from getting caught on under sink obstructions • easy to install • ships fully assembled • sleeve can be cut to accommodate different cabinet sizes • compatible with all Moen® kitchen pulldown and pullout single-handle sidemount SKUs (excludes Aberdeen)	159060	23.60	Chrome	6

All Brushed Nickel, Polished Brass and Polished Nickel faucet components feature the LifeShine® Non-Tarnish Finish.

		MODEL NUMBER	LIST PRICE	DESCRIPTION	CASE QTY
SIDE SPRAY SERVICE AND ADAPTER KITS					
	Side spray plug service kit • plug hose outlet to eliminate quick connect system kitchen side spray	143530	10.85	-	144
	Side spray adapter kit • for faucets with external threads • converts side spray outlet to quick-connect	168665	35.85	-	50
	Side spray adapter kit • for faucets with internal threads • converts side spray outlet to quick-connect	168666	23.05	-	50
LAVATORY WASTE ASSEMBLIES					
	Lavatory drain assembly • all metal	10790	90.55	Chrome	12
	Lavatory drain assembly, non-metallic	14526	55.40	Chrome	0
	Lavatory drain assembly, non-metallic plug, metal seat	96497	68.65	Chrome	12
	Lavatory drain plug and threaded seat assembly • non-metallic • works with metal drain body 10790 only	10709	14.65	Chrome	84
		10709BC	20.50	Brushed Chrome	20
		10709BN	50.70	Brushed Nickel	20
		10709ORB	50.70	Oil Rubbed Bronze	20
		10709WR	50.70	Wrought Iron	50
	Lavatory drain assembly • ideal for vessel sinks • spring loaded push button • without overflow	140780	94.40	Chrome	12
		140780BN	136.05	Brushed Nickel	12
		140780ORB	136.05	Oil Rubbed Bronze	12
		NEW! 140780BL	136.05	Matte Black	12
		NEW! 140780BG	136.05	Brushed Gold	-
	Lavatory drain assembly • spring loaded push button • with overflow	131553	94.20	Chrome	12
		131553BN	138.85	Brushed Nickel	12
		131553NL	138.85	Polished Nickel	12
		131553ORB	138.85	Oil Rubbed Bronze	12
		NEW! 131553BL	138.85	Matte Black	-
	NEW! 131553BG	138.85	Brushed Gold	-	
	Grid drain without overflow	123816	67.60	Chrome	12
		123816BN	112.50	Brushed Nickel	12
		123816ORB	112.50	Oil Rubbed Bronze	12

All Brushed Nickel, Polished Brass and Polished Nickel faucet components feature the LifeShine® Non-Tarnish Finish.

		MODEL NUMBER	LIST PRICE	DESCRIPTION	CASE QTY
EXTENSION KITS					
	Thick deck extension kit for hose guides	100816	34.90	-	50
	Thick deck extension kit for single-handle kitchens • cannot be used with flex lines	100817	37.10	-	100
	Thick deck extension kit for valves with 1/2" threaded mounting shanks	100818	51.50	-	20
	Low profile mounting nut • fits 1/2" threaded shanks • 2 per kit	145665	6.75	-	-
	Deck extension kit, single-handle kitchen with quick connect system • does not work with current pullout faucets that have hose through mounting shank	137114	97.45	-	20
	1/2" single-handle shower escutcheon extension • fits all single-handle tub/showers with 7" escutcheon	162	121.35	Chrome	6
HANDLE EXTENSION KITS					
	1" handle extension kit, Posi-Temp® single-handle tub/shower	96945	56.70	Chrome	100
		96945BN	89.30	Brushed Nickel	9
		96858	82.85	Polished Brass	0
		96945WR	89.45	Wrought Iron*	9
		96955	57.20	Chrome	1
	2" handle extension kit to correct deep rough-in	96868	92.80	Polished Brass	0
	<i>*Wrought iron can be used with Oil Rubbed Bronze finish</i>				
	1" handle extension kit, Moentrol® single-handle tub/shower	137347	51.95	Chrome	9
		137347P	100.45	Polished Brass	9
		137347BN	100.45	Brushed Nickel	9
		137347WR	100.45	Wrought Iron*	9
	<i>*Wrought iron can be used with Oil Rubbed Bronze finish</i>				
	Body spray extension kit • fits TS1320, TS1322, TS1420 and TS1422 body sprays • 1" extension	155656	41.95	-	-

All Brushed Nickel, Polished Nickel and Polished Brass faucet components feature the LifeShine® Non-Tarnish Finish.

		MODEL NUMBER	LIST PRICE	DESCRIPTION	CASE QTY
HANDLE EXTENSION KITS (CONTINUED)					
	Large volume control escutcheon ring • covers holes up to 2-1/2" diameter • to be used with volume control trim	129102	42.50	Chrome	12
		129102BN	76.50	Brushed Nickel	12
		129102ORB	76.50	Oil Rubbed Bronze	12
		129102WR	76.50	Wrought Iron	12
		129102NL	76.50	Polished Nickel	12
	Handle extension kits for ExactTemp® shallow wall installs (thicker ring) • 3/4" extension • to be used with volume control trim	130153	40.85	Chrome	12
		130153BN	69.80	Brushed Nickel	-
		130153NL	69.80	Polished Nickel	12
		130153ORB	69.80	Oil Rubbed Bronze	12
		130153WR	69.80	Wrought Iron	12
	Handle extension kits for models prior to July 2007 1" handle extension kit, 5-function transfer valve, knob handle • can be used with the 8360 Commercial 3-function	106321	161.60	-	6
		105320	159.45	-	0
	Handle extension kits for models after July 2007 1" handle extension kit, 3-function transfer valve <i>*Wrought Iron can be used with Oil Rubbed Bronze finish</i>	135167	57.85	Chrome	9
		135167BN	163.15	Brushed Nickel	9
		135167WR	163.15	Wrought Iron*	9
	1" handle extension kit, Legend® & Chateau® single-handle tub/shower	10399	59.50	Chrome	36
		99503	81.15	Polished Brass	0
	Thread adapter and extension • for S3371 after September 2009; 3/4" extension	147206	91.30	-	12
	1" handle control extension kit • for use with volume control trim	147212	31.10	-	12
	1" extension kit • for use with transfer valve trim (three-function transfer valve trim kit) <i>*Wrought Iron can be used with Oil Rubbed Bronze finish</i>	148479	34.15	Chrome	25
		148479BN	64.80	Brushed Nickel	25
		148479WR	64.80	Wrought Iron*	25
	Roman tub stem extension • adapts to all 3-hole roman tub valves	106378	22.05	Chrome	250

All Brushed Nickel, Polished Brass and Polished Nickel faucet components feature the LifeShine® Non-Tarnish Finish.







		MODEL NUMBER	LIST PRICE	DESCRIPTION	CASE QTY
ADJUSTABLE TEMPERATURE LIMIT STOPS					
	Legend® or Chateau® Stop tube with adjustable temperature limit stop	10510	28.50	Chrome	30
	Moentrol® Stop tube with adjustable temperature limit stop Moentrol® single-handle tub/shower	10066 10066BN 10066WR 10066P	28.50 41.00 41.00 41.00	Chrome Brushed Nickel Wrought Iron* Polished Brass	125 20 20 0
<i>*Wrought Iron can be used with Oil Rubbed Bronze finish</i>					
	Posi-Temp® Adjustable temperature limit stop, Posi-Temp®	96987 96987BN 96987WR 15972	13.05 23.75 23.75 22.65	Chrome Brushed Nickel Wrought Iron* Polished Brass	20 20 20 24
<i>*Wrought Iron can be used with Oil Rubbed Bronze finish</i>					
	Temperature limit stop kit, Posi-Temp® single-handle tub/shower	106479	5.30	-	300
	Push-button diverter plug	101100	20.60	-	100
	Moentrol® Adapter for standard 1H tub/shower valves to use Moentrol® trim • attaches to standard valves to fit today's Moentrol® trim	145058	21.85	-	50
LAVATORY CONVERSION KIT - KNOB TO LEVER HANDLE					
	Handle conversion kit, knob to lever, Chateau® single-handle lav - Models prior to April 2003	100679	69.05	Chrome	12
TUB/SHOWER CONVERSION KITS - KNOB TO LEVER HANDLE					
	Lever handle kit, Chateau® and Moentrol® single-handle tub/shower	100224 100224P	23.45 36.60	Chrome Polished Brass	45 0

M-Line





M-Line Moen Remodel Cover Plate / M1921

M-LINE Kitchen and Bathroom Accessories

		MODEL NUMBER	LIST PRICE	FINISH/ CONNECTION	CASE QTY
ACCESSORIES					
	<ul style="list-style-type: none"> • Strainer • Open Grid • CSA Approved 	M9955BL	39.75	Chrome	36
	<ul style="list-style-type: none"> • Strainer • Open Grid • Offset for handicap sinks • CSA Approved 	M9957BL	60.35	Chrome	36
	<ul style="list-style-type: none"> • 17" Rainshower arm w/flange 	M1720BL	55.85	Chrome	6
		M1725BL	69.80	Brushed Nickel	6
	<ul style="list-style-type: none"> • Diverter tub spout • Universal fit • 1/2" & 3/4" FIP, 1/2" slip fit • CSA approved 	M1460BL	16.50	Chrome	50
	<ul style="list-style-type: none"> • Universal Drop Elbow • Slip Fit, 1/2" IPS and 3/4" IPS • CSA approved 	M1510BL	20.95	Chrome	50
	<ul style="list-style-type: none"> • Remodeling cover plate • All metal construction • Converts two or three handle shower faucets to single handle 	M1921	71.85	Chrome	20
		M1923	112.55	Brushed Nickel	20
	<ul style="list-style-type: none"> • Shower Diverter • CSA approved 	M1941	23.85	Chrome	72

M-LINE Kitchen and Bathroom Accessories

		MODEL NUMBER	LIST PRICE	FINISH/ CONNECTION	CASE QTY
ACCESSORIES (CONTINUED)					
	<ul style="list-style-type: none"> Deluxe soap/lotion dispenser 	M2070	28.10	Chrome	24
		M2072	35.10	Brushed Nickel	24
	<ul style="list-style-type: none"> Deluxe soap/lotion dispenser 	M2073	28.10	Chrome	24
		M2074	28.10	White	24
		M2075	35.10	Brushed Nickel	24
	<ul style="list-style-type: none"> Deluxe soap/lotion dispenser 	M2060	22.55	Chrome	10



Commercial Products Catalogue 2019



Products that address your highest priorities.

From leaks and vandalism to normal wear and tear, worries never cease where commercial and institutional fixtures are concerned. That's why Moen® Commercial engineers and designers think of every imaginable scenario — and plan for it in advance. The result is a full line of faucets and valves every facilities manager can rely on from the number one faucet brand in North America.

Our products will help you:

- reduce maintenance costs
- resist vandalism
- save water while maintaining performance
- cut your total cost of ownership

On the pages ahead, we welcome you to discover all the reasons you can count on Moen Commercial to provide the best solutions for your most challenging environments.

Contents

381	M•DURA™ Modern Suite
382	M•DURA™ Heavy-Duty Faucets
400	M•PRESS™ Heavy-Duty Metering Faucets
404	M•BITION™ Medium-Duty Faucets
412	M•POWER™ Sensor-Operated Faucets
420	M•POWER™ Sensor-Operated Flush Valves
424	M•DURA™ Heavy-Duty Manual Flush Valves
429	M•DURA™ Heavy-Duty Showering

COMMERCIAL



M•DURA Two-Handle Centerset Faucet / 8279SM

Built for the real world.

Moen® Commercial understands the demanding environments of commercial and institutional facilities. Just as importantly, we understand what satisfies demanding professionals like you.

That's why we go beyond manufacturing durable, reliable products that include vandal-resistant and energy-efficient options. Our products offer lower lifetime costs to help you meet financial goals too. Plus, we stand behind everything with a best-in-class warranty and outstanding customer service so you can have confidence in your decision to choose Moen® Commercial. Real-world performance. Real-world reliability.

Moen 5-Year Limited Warranty



We're so confident in the performance of our products that we back them with a 5-Year Limited Warranty. If they should ever drip, leak or prove to have a finish defect, we'll send you the replacement parts, free of charge. Just call 1-800-465-6130 or see your Moen dealer for complete details.



Water-saving feature when compared to industry standards



Americans with Disabilities Act (ADA) compliant



Indicates Moen® Commercial products that are certified to meet WaterSense® labeling criteria and contribute toward maximizing LEED® points

Moen products comply with the Safe Drinking Water Act's stringent lead safety standards.

Each product in this catalog has been identified by:

- ▲ NSF 61/9 and 372 compliant
- NSF 372 compliant
- Non-drinking water faucet

COMMERCIAL

The M•DURA™ Modern Suite

Designed to impress, built to last

The M•DURA™ Modern Suite is the answer to your need for elegant, residential-influenced styling with essential built-in durability for high-use commercial environments.

The Commercial Modern Suite offers two M•DURA heavy-duty lavatory faucets featuring cast-brass construction, durable ceramic cartridges and vandal-resistant aerators and handle assemblies.

Also available in multiple tub and showering configurations, the Modern Suite is built with vandal-resistant and ADA compliant features, including a three-function discrete transfer and handshower with non-positive pause in designated offerings.

With the new Modern Suite, facilities can achieve the best of both worlds — sleek, modern styling and commercial-grade quality.

The M•DURA Modern Suite. Timeless Design. Built to Last.



M•DURA™
LAVATORY



9419F12
One-Handle, Heavy-Duty, Single-Mount
with metal drain
See page 383.



9223F12
Two-Handle, Heavy-Duty, Widespread
with metal drain
See page 384.

M•DURA™
SHOWERING



T9360
Three-Function Transfer
Valve Trim
See page 441.



T9389
Posi-Temp® Tub/Shower Trim
See page 434.



9263
Heavy-Duty Showerhead
See page 439.



9349
Heavy-Duty Handshower
See page 438.



T9342EP15
Posi-Temp® Tub/Shower with Three-
Function Transfer Trim, handshower
and slide bar
See page 430.



T9342GBM15
Posi-Temp® Tub/Shower with Three-
Function Transfer Trim, handshower
and slide bar/grab bar
See page 431.

COMMERCIAL





M•DURA™ Heavy-Duty Faucets



M•DURA™ Modern Widespread Lavatory Faucet / 9220 and 9223 Series

M•DURA™ Heavy-Duty Lavatory Faucets



- 
Real-World Reliability: Heavy Duty Construction
 Solid cast-brass body is made heavy to last long, with added protection from a wear-resistant chrome finish.
- 
Tested Durability: Ceramic Disc Cartridge
 Protected by a free-spinning hub and tamperproof screws, the heavy-duty cartridge features internal stops that prevent misalignment and ensure complete shutoff.
- 
Vandal Resistant Operation: Recessed Aerator
 Unique design can only be removed by authorized personnel.
- 
Updated Appearance: Easy-to-Clean Styling
 Softened angles and lack of recesses resist dirt buildup.
- 
Worry-Free Quality: Best-in-Class Five Year Limited Warranty

COMMERCIAL





























	MODEL NUMBER	LIST PRICE	CASE QTY	
MODERN SINGLE-MOUNT LAVATORY FAUCET†				
	<ul style="list-style-type: none"> • Single-mount • Cast brass • 3½" lever handle • 1.2 gpm [4.5 lpm] max. vandal-resistant aerator • 3/8" compression connections • 22" supply line • No lift rod hole Brass adjustable temperature limit stop	9417F12	347.30	3
	<ul style="list-style-type: none"> • 0.5 gpm [1.9 lpm] max. vandal resistant aerator 	9417F05	347.30	3
	<ul style="list-style-type: none"> • 1.2 gpm [4.5 lpm] max. vandal-resistant aerator • With metal drain 	9419F12	385.85	3
	<ul style="list-style-type: none"> • 0.5 gpm [1.91 lpm] max. vandal-resistant aerator • With metal drain 	9419F05	385.85	3
	<ul style="list-style-type: none"> • 4" optional deckplate 	99559	39.75	20



† 1255® Duralast® Cartridge

M•DURA™ Heavy-Duty Lavatory Faucets

COMMERCIAL

	MODEL NUMBER	LIST PRICE	CASE QTY	
MODERN WIDESPREAD LAVATORY FAUCET*				
	<ul style="list-style-type: none"> • 8" widespread • Cast brass • 3" lever handles • 1.2 gpm [4.5 lpm] max. vandal-resistant aerator • ½" IPS connections • Without drain • No lift rod hole    	9220F12	428.15	3
	<ul style="list-style-type: none"> • 0.5 gpm [1.9 lpm] max. vandal resistant aerator • Without drain   	9220F05	428.15	3
	<ul style="list-style-type: none"> • 1.2 gpm [4.5 lpm] max. vandal-resistant aerator • With metal drain    	9223F12	475.65	3
	<ul style="list-style-type: none"> • 0.5 gpm [1.9 lpm] max. vandal-resistant aerator • With metal drain   	9223F05	475.65	3
CENTRESET LAVATORY FAUCET*				
	<ul style="list-style-type: none"> • 4" centreset • Cast brass • 2½" lever handles • 2.2 gpm [8.3 lpm] max. vandal-resistant aerator • ½" IPS connections • Without drain • No lift rod hole  	8210	236.05	6
	<ul style="list-style-type: none"> • 1.2 gpm [4.5 lpm] max. vandal resistant aerator    	8210F12	236.05	6
	<ul style="list-style-type: none"> • 0.5 gpm [1.9 lpm] max. vandal-resistant aerator   	8210F05	236.05	6
	<ul style="list-style-type: none"> • 2.2 gpm [8.3 lpm] max. vandal-resistant aerator • With metal drain   	8216	281.45	6

*Ceramic Disc Cartridges (52000 Hot; 52001 Cold)

▲ NSF 6 1/9 and 372 compliant ♿ ADA compliant ♻️ WaterSense® 🌿 Water-saving

M•DURA™ Heavy-Duty Lavatory Faucets

	MODEL NUMBER	LIST PRICE	CASE QTY	
CENTRESET LAVATORY FAUCET*				
 <ul style="list-style-type: none"> • 4" centreset • Cast brass • 4" wrist blade handles • 2.2 gpm [8.3 lpm] max. vandal-resistant aerator • ½" IPS connections • Without drain • No lift rod hole 	8215	258.80	6	
	<ul style="list-style-type: none"> • 1.2 gpm [4.5 lpm] max. vandal resistant aerator 	8215F12	258.80	6
	<ul style="list-style-type: none"> • 0.5 gpm [1.9 lpm] max. vandal-resistant aerator 	8215F05	258.80	6
	<ul style="list-style-type: none"> • 0.35 gpm [1.3 lpm] max. vandal-resistant aerator 	8215F03	258.80	6
	<ul style="list-style-type: none"> • 2.2 gpm [8.3 lpm] max. vandal-resistant aerator • With metal drain 	8219	304.15	6



WIDESPREAD LAVATORY FAUCET*				
 <ul style="list-style-type: none"> • 8" widespread • Cast brass • 2½" lever handles • 2.2 gpm [8.3 lpm] max. vandal-resistant aerator • ½" IPS connections • Without drain • No lift rod hole 	8220	388.60	6	
	<ul style="list-style-type: none"> • 0.5 gpm [1.9 lpm] max. vandal-resistant aerator 	8220F05	388.60	3
	<ul style="list-style-type: none"> • 2.2 gpm [8.3 lpm] max. vandal-resistant aerator • With metal drain 	8223	434.25	6

COMMERCIAL

*Ceramic Disc Cartridges (52000 Hot; 52001 Cold)

▲ NSF 6 1/9 and 372 compliant ♿ ADA compliant ♻️ WaterSense® 🌿 Water-saving



























M•DURA™ Heavy-Duty Lavatory Faucets

		MODEL NUMBER	LIST PRICE	CASE QTY
WIDESPREAD LAVATORY FAUCET*				
	<ul style="list-style-type: none"> • 8" widespread • Cast brass • 4" wrist blade handles • 2.2 gpm [8.3 lpm] max. vandal-resistant aerator • ½" IPS connections • Without drain • No lift rod hole 	8228	410.65	6
	<ul style="list-style-type: none"> • 1.2 gpm [4.5 lpm] max. vandal-resistant aerator 	8228F12	410.65	3
	<ul style="list-style-type: none"> • 0.5 gpm [1.9 lpm] max. vandal-resistant aerator 	8228F05	410.65	3
	<ul style="list-style-type: none"> • 2.2 gpm [8.3 lpm] max. vandal-resistant aerator • With metal drain 	8239	454.80	6
MANUAL-TO-METERING CONVERSION KIT**				
	Manual-to-metering conversion kit. Convert any M•DURA™ 8200 series faucet† to an M•PRESS™ metering faucet with a simple cartridge and handle change. Includes hot/cold colour indicator rings.	52120	312.35	12
	† Excludes 8242, 8244, 8281, 8286 and new Modern Lavs			
CENTRESET LAVATORY FAUCET**				
 Chrome	<ul style="list-style-type: none"> • 4" centreset • Cast brass • 2½" lever handle • 2.2 gpm [8.3 lpm] max. aerator • ½" IPS connections • Without drain • No lift rod hole • Adjustable temperature limit stop 	8413	228.05	6
	<ul style="list-style-type: none"> • 1.2 gpm [4.5 lpm] max. aerator 	8413F12	228.05	3
	<ul style="list-style-type: none"> • 0.5 gpm [1.9 lpm] max. aerator 	8413F05	228.05	3
	<ul style="list-style-type: none"> • 0.35 gpm [1.3 lpm] max. aerator 	8413F03	228.05	3
	<ul style="list-style-type: none"> • 2.2 gpm [8.3 lpm] max. aerator • With metal drain 	8414	276.15	6

*Ceramic Disc Cartridges [52000 Hot; 52001 Cold] **Ceramic Disc Cartridge [121549]

▲ NSF 6 1/9 and 372 compliant ♿ ADA compliant ♻️ WaterSense® ♻️ Water-saving











M•DURA™ Heavy-Duty Lavatory Faucets

	MODEL NUMBER	LIST PRICE	CASE QTY		
CENTRESET LAVATORY FAUCET**					
	<ul style="list-style-type: none"> • 4" centreset • Cast brass • 6" lever handle • 2.2 gpm [8.3 lpm] max. aerator • ½" IPS connections • Without drain • No lift rod hole • Adjustable temperature limit stop 	8416	249.50	6	
	 	<ul style="list-style-type: none"> • 0.5 gpm [1.9 lpm] max. aerator 	8416F05	249.50	3
	  				
SINGLE-MOUNT LAVATORY FAUCET**					
	<ul style="list-style-type: none"> • Single-mount • Cast brass • 2½" lever handle • 2.2 gpm [8.3 lpm] max. aerator • 3/8" compression connections • 22" supply line • Without drain • No lift rod hole • Adjustable temperature limit stop 	8417	280.70	6	
	 	<ul style="list-style-type: none"> • 1.2 gpm [4.5 lpm] max. aerator 	8417F12	280.70	6
	   	<ul style="list-style-type: none"> • 0.5 gpm [1.9 lpm] max. aerator 	8417F05	280.70	6
	  	<ul style="list-style-type: none"> • 1.2 gpm [4.5 lpm] max. aerator • With metal grid strainer 	8419F12	337.85	6
	   	<ul style="list-style-type: none"> • 0.5gpm [1.91 lpm] max. aerator 	8419F05	337.85	6
	  				
SINGLE-MOUNT LAVATORY FAUCET**					
	<ul style="list-style-type: none"> • Single-mount • Cast brass • 6" lever handle • 2.2 gpm [8.3 lpm] max. aerator • 3/8" compression connections • 22" supply line • Without drain • No lift rod hole • Adjustable temperature limit stop 	8418	300.50	6	
	 				

COMMERCIAL

*Ceramic Disc Cartridges [52000 Hot; 52001 Cold] **Ceramic Disc Cartridge [121549]
 NSF 6 1/9 and 372 compliant  ADA compliant  WaterSense®  Water-saving

M•DURA™ Heavy-Duty Lavatory and Kitchen Faucets

	MODEL NUMBER	LIST PRICE	CASE QTY	
WIDESPREAD LAVATORY FAUCET*				
	<ul style="list-style-type: none"> • 8" widespread • Solid brass construction • 4" wrist blade handles • 1.5 gpm [5.7 lpm] max. aerator • 8" spout reach • ½" IPS connections • Without drain • Includes optional 2.0 gpm [7.6 lpm] max. laminar flow spout base conversion kit† 	8225	416.05	6
	 			
<hr/>				
	<ul style="list-style-type: none"> • Without spout See page 399 for spout options 	8229	330.20	6
	 			
WIDESPREAD KITCHEN FAUCET*				
	<ul style="list-style-type: none"> • 8" widespread • Cast brass • 2½" lever handles • 1.5 gpm [5.7 lpm] max. vandal-resistant aerator • ½" IPS connections • Without drain • Adjustable temperature limit stop 	8227	392.50	6
	 			
<hr/>				
	<ul style="list-style-type: none"> • Without spout See page 399 for spout options 	8226	305.50	6
	 			







COMMERCIAL

Optional spouts available on page 399.

*Ceramic Disc Cartridges (52000 Hot; 52001 Cold)

 NSF 6 1/9 and 372 compliant  ADA compliant  Water-saving

M•DURA™ Heavy-Duty Kitchen Faucets

	MODEL NUMBER	LIST PRICE	CASE QTY
CENTRESET LAVATORY FAUCET**			
 <ul style="list-style-type: none"> • 8" widespread • Solid brass construction • 4" wrist blade handles • 1.2 gpm [4.5 lpm] max. aerator • 8" spout reach • Chrome side spray • ½" IPS connections  	8244	453.70	6
WIDESPREAD KITCHEN FAUCET*			
 <ul style="list-style-type: none"> • 8" widespread • Solid brass construction • 4" wrist blade handles • 1.2 gpm [4.5 lpm] max. aerator • 5¼" spout reach • ½" IPS connections • Without drain • Includes optional 2.0 gpm [7.6 lpm] max. laminar flow spout base conversion kit .  	8248	406.35	6

















COMMERCIAL

Optional spouts available on page 399.

*Ceramic Disc Cartridges (52000 Hot; 52001 Cold) **Ceramic Disc Cartridge (52001 Cold)

▲ NSF 6 1/9 and 372 compliant  ADA compliant  Water-saving

M•DURA™ Heavy-Duty Kitchen Faucets



		MODEL NUMBER	LIST PRICE	CASE QTY
KITCHEN FAUCET*				
	<ul style="list-style-type: none"> • 8" deckmount • Solid brass construction • 4" wrist blade handles • 1.5 gpm [5.7 lpm] max. aerator • 9½" spout reach • ½" IPS connections 	8282	353.30	6
	 			
WIDESPREAD KITCHEN FAUCET*				
	<ul style="list-style-type: none"> • 8" deckmount • Solid brass construction • 2½" lever handles • 1.5 gpm [5.7 lpm] max. aerator • 9½" spout reach • ½" IPS connections 	8283	326.35	6
	 			
KITCHEN FAUCET*				
	<ul style="list-style-type: none"> • 8" deckmount • Solid brass construction • 2½" lever handles • 1.5 gpm [5.7 lpm] max. aerator • 8" spout reach • ½" IPS connections 	8287	324.25	6
	 			
	<ul style="list-style-type: none"> • Without spout See page 399 for spout options	8280	238.50	6
	 			
KITCHEN FAUCET*				
	<ul style="list-style-type: none"> • 8" deckmount • Solid brass construction • 4" wrist blade handles • 1.5 gpm [5.7 lpm] max. aerator • 8" spout reach • ½" IPS connections • Includes optional 2.0 gpm [7.6 lpm] max. laminar flow spout base conversion kit 	8289	351.30	6
	 			
	<ul style="list-style-type: none"> • Without spout See page 399 for spout options	8285	265.55	6
	 			

Optional spouts available on page 399.

*Ceramic Disc Cartridges (52000 Hot; 52001 Cold) **1255® Duralast® Cartridge

 NSF 6 1/9 and 372 compliant  ADA compliant  Water-saving

M•DURA™ Heavy-Duty Kitchen Faucets

	MODEL NUMBER	LIST PRICE	CASE QTY
SINGLE-HANDLE KITCHEN FAUCET**			
 <ul style="list-style-type: none"> • Single-mount/deckmount • Solid brass construction • 4" lever handle • 1.5 gpm [5.7 lpm] max. aerator • 9" spout reach • 22" supply line • Flexible supplies with 3/8" compression connection • Includes optional 8" deckplate • Brass adjustable temperature limit stop 	8701	244.10	12
	<ul style="list-style-type: none"> • 12" spout reach 	8711	270.40
SINGLE-HANDLE KITCHEN FAUCET**			
 <ul style="list-style-type: none"> • Single-mount/deckmount with chrome side spray • Solid brass construction • 4" lever handle • 1.5 gpm [5.7 lpm] max. aerator • 9" spout reach • 22" supply line • Flexible supplies with 3/8" compression connection • Includes optional 8" deckplate • Brass adjustable temperature limit stop. 	8707	276.40	-
	<ul style="list-style-type: none"> • 12" spout reach 	8717	303.65
SINGLE-HANDLE WALLMOUNT KITCHEN FAUCET**			
 <ul style="list-style-type: none"> • 7½"-8½" application • Solid brass construction • 4" lever handle • 1.5 gpm [5.7 lpm] max. aerator • 9" spout reach • ½" eccentric connections • Brass adjustable temperature limit stop 	8713	558.25	12
	<ul style="list-style-type: none"> • 12" spout reach 	8714	566.05

COMMERCIAL

Optional spouts available on page 399.

*Ceramic Disc Cartridges (52000 Hot; 52001 Cold) **1255® Duralast® Cartridge
 ▲ NSF 6 1/9 and 372 compliant ♿ ADA compliant ♻ Water-saving

M•DURA™ Heavy-Duty Bar/Pantry Faucets

		MODEL NUMBER	LIST PRICE	CASE QTY
BAR/PANTRY FAUCET*				
	<ul style="list-style-type: none"> • 4" centreset • Cast brass • 2½" lever handles • 1.2 gpm [4.5 lpm] max. vandal-resistant laminar flow • 3 5/8" spout reach • ½" IPS connections • Without drain 	8270	288.50	6
	 			
	<ul style="list-style-type: none"> • 5¼" spout reach 	8272	298.90	6
	 			
BAR/PANTRY FAUCET*				
	<ul style="list-style-type: none"> • Without spout See page 399 for spout options	8274	219.75	6
	 			
BAR/PANTRY FAUCET*				
	<ul style="list-style-type: none"> • 4" centreset • Cast brass • 4" wrist blade handles • 1.2 gpm [4.5 lpm] max. vandal-resistant laminar flow • 3 5/8" spout reach • ½" IPS connections • Without drain 	8278	297.10	6
	 			
	<ul style="list-style-type: none"> • 5¼" spout reach 	8279	303.00	6
	 			
	<ul style="list-style-type: none"> • Without spout See page 399 for spout options	8276	229.45	6
	 			

Optional spouts available on page 399.

*Ceramic Disc Cartridges (52000 Hot; 52001 Cold) **1255® Duralast® Cartridge

▲ NSF 6 1/9 and 372 compliant ■ Non-drinking water faucet ♿ ADA compliant

M•DURA™ Heavy-Duty Multi-Purpose Faucets

	MODEL NUMBER	LIST PRICE	CASE QTY	
SINGLE-HANDLE MULTIPURPOSE FAUCET**				
	<ul style="list-style-type: none"> • 4"-8" application • 4" lever handle • 1.5 gpm [5.7 lpm] max. aerator • Solid brass construction • 5¼" spout reach • Flexible supplies with 3/8" compression connection • Brass adjustable temperature limit stop 	8137	281.30	6
	<ul style="list-style-type: none"> • Without spout <p>See page 399 for spout options</p>	8125	216.95	6













COMMERCIAL

Optional spouts available on page 399.

*Ceramic Disc Cartridges (52000 Hot; 52001 Cold) **1255® Duralast® Cartridge
 ▲ NSF 6 1/9 and 372 compliant ■ Non-drinking water faucet ♿ ADA compliant

M•DURA™ Heavy-Duty Multi-Purpose Faucets





		MODEL NUMBER	LIST PRICE	CASE QTY
WALLMOUNT UTILITY FAUCET*				
	<ul style="list-style-type: none"> • 7½" - 8½" application • Cast brass • 2½" lever handles • 1.5 gpm [5.7 lpm] max. aerator • 12" spout reach • ½" IPS eccentric connections 	8119	395.15	6
	 			
FAUCET*				
	<ul style="list-style-type: none"> • 7½" - 8½" application • Cast brass • 4" wrist blade handles • 1.5 gpm [5.7 lpm] max. aerator • 8" spout reach • ½" IPS eccentric connections 	8126	371.40	6
	 			
	<ul style="list-style-type: none"> • Without spout • 4" wrist blade handles <p>See page 399 for spout options</p>	8121	287.30	6
	 			
SERVICE SINK FAUCET*				
	<ul style="list-style-type: none"> • 7½" - 8½" application • Cast brass • 2½" lever handles • 9 3/8" spout reach • Unrestricted flow • ¾" garden hose thread • Vacuum breaker • Service stops • Wallmounting bracket • Pail hook • ½" IPS eccentric connections • Rough Chrome finish 	8230	270.05	3
	 			

Optional spouts available on page 399.

*Ceramic Disc Cartridges (52000 Hot; 52001 Cold)

▲ NSF 6 1/9 and 372 compliant ■ Non-drinking water faucet ♿ ADA compliant

M•DURA™ Heavy-Duty Multi-Purpose Faucets

		MODEL NUMBER	LIST PRICE	CASE QTY
SERVICE SINK FAUCET*				
	<ul style="list-style-type: none"> • 7½" - 8½" application • Cast brass • 2½" lever handles • 10¼" spout reach • Unrestricted flow • ¾" garden hose thread • Vacuum breaker • Service stops • Internal check stops prevent crossflow • Wallmounting bracket • Integral check stops • Pail hook • ½" IPS eccentric connections • Polished Chrome finish. 	8124	391.60	6
	 			
MOP HANGER				
	<ul style="list-style-type: none"> • Stainless steel • Holds 3 handles • Mounting hardware included 	8198	78.05	10
HOSE BRACKET				
	<ul style="list-style-type: none"> • Stainless steel • 30" heavy-duty rubber hose • Mounting hardware included 	8199	53.15	10







COMMERCIAL

Optional spouts available on page 399.

*Ceramic Disc Cartridges (52000 Hot; 52001 Cold)

▲ NSF 6 1/9 and 372 compliant ■ Non-drinking water faucet ♿ ADA compliant

M•DURA™ Heavy-Duty Laboratory Faucets

		MODEL NUMBER	LIST PRICE	CASE QTY
LABORATORY FAUCET*				
	<ul style="list-style-type: none"> • Single mount • Cast brass • 2½" lever handle • 2.2 gpm [8.3 lpm] max. aerator • 5¼" spout reach • 22" supply line • 3/8" compression connections 	8103	201.75	6
	 			
LABORATORY FAUCET*				
	<ul style="list-style-type: none"> • Single mount • Cast brass • 2½" lever handle • Unrestricted flow • 6" vacuum-breaker spout with hose nozzle • 22" supply line • 3/8" compression connections 	8106	288.30	6
	 			
LABORATORY FAUCET*				
	<ul style="list-style-type: none"> • Single mount • Cast brass • 2½" lever handles • 2.2 gpm [8.3 lpm] max. aerator • 5¼" spout reach • 22" supply line • 3/8" compression connections 	8113	305.05	6
	 			
LABORATORY FAUCET*				
	<ul style="list-style-type: none"> • Single mount • Cast brass • 2½" lever handles • Unrestricted flow • 6" vacuum-breaker spout with hose nozzle • 22" supply line • 3/8" compression connections 	8116	391.55	6
	 			











Optional spouts available on page 399.

*Ceramic Disc Cartridges (52000 Hot; 52001 Cold)

▲ NSF 6 1/9 and 372 compliant ■ Non-drinking water faucet

♿ ADA compliant ♻ Water-saving

M•DURA™ Heavy-Duty Specialty Faucets for Healthcare Applications

	MODEL NUMBER	LIST PRICE	CASE QTY
SPECIALTY FAUCET FOR HEALTHCARE APPLICATIONS*			
 <ul style="list-style-type: none"> • 8" widespread • Solid brass construction • 4" smooth wrist blade handles • 1.2 gpm [4.5 lpm] max. aerator • 5¼" spout reach • ½" IPS connections • Without drain • Includes optional 1.5 gpm [5.7 lpm] max. laminar flow spout base conversion kit   	8248SMF12	406.35	3
SPECIALTY FAUCET FOR HEALTHCARE APPLICATIONS*			
 <ul style="list-style-type: none"> • 8" widespread • Solid brass construction • 4" smooth wrist blade handles • 1.5 gpm [5.7 lpm] max. aerator • 8" spout reach • ½" IPS connections • Without drain • Includes optional 1.5 gpm [5.7 lpm] max. laminar flow spout base conversion kit   	8225SMF15	415.90	3
SPECIALTY FAUCET FOR HEALTHCARE APPLICATIONS*			
 <ul style="list-style-type: none"> • 4" centreset • Cast brass • 4" smooth wrist blade handles • 1.2 gpm [4.5 lpm] max. vandal-resistant laminar flow • 3 5/8" spout reach • ½" IPS connections • Without drain   	8278SMF12	297.10	6

COMMERCIAL

Optional spouts available on page 399.

*Ceramic Disc Cartridges (52000 Hot; 52001 Cold)

▲ NSF 6 1/9 and 372 compliant ■ Non-drinking water faucet

♿ ADA compliant ♻ Water-saving

M•DURA™ Heavy-Duty Specialty Faucets for Healthcare Applications

	MODEL NUMBER	LIST PRICE	CASE QTY
--	--------------	------------	----------

SPECIALTY FAUCET FOR HEALTHCARE APPLICATIONS*



- 4" centreset
- Cast brass
- **4" smooth wrist blade handles**
- 1.2 gpm [4.5 lpm] max. vandal-resistant laminar flow
- 5¼" spout reach
- ½" IPS connections
- Without drain
- Includes optional 1.5 gpm [5.7 lpm] max. laminar flow spout base conversion kit

8279SMF12

303.00

6



SPECIALTY FAUCET FOR HEALTHCARE APPLICATIONS*



- 4" centreset
- Cast brass
- **2½" smooth lever handles**
- 1.2 gpm [4.5 lpm] max. vandal-resistant aerator
- ½" IPS connections
- Without drain
- No lift rod hole

8210SMF12

236.05

6



SPECIALTY FAUCET FOR HEALTHCARE APPLICATIONS*



- 4" centreset
- Cast brass
- **4" smooth wrist blade handles**
- 1.2 gpm [4.5 lpm] max. vandal-resistant aerator
- ½" IPS connections
- Without drain
- No lift rod hole

8215SMF12

258.80

6



COMMERCIAL

All spouts include 2.2 gpm [8.3 lpm] max. aerators.

*Ceramic Disc Cartridges (52000 Hot; 52001 Cold) **Height from spout nut base plane to aerator

▲ NSF 6 1/9 and 372 compliant Non-drinking water faucet

♿ ADA compliant WaterSense® Water-saving

DOUBLE-BEND SPOUTS



S0003



S0010

Model Number	Reach	Base to Aerator**	Overall Height	Weight Each Pounds	Case Quantity	List Price
S0001 ▲	6.00"	3.75"	7.375"	1.20	12	74.35
S0002 ▲	6.00"	5.00"	9.125"	1.64	12	98.25
S0003 ▲	6.00"	5.75"	9.75"	1.60	12	77.70
S0004 ▲	6.00"	8.50"	12.75"	1.71	12	92.95
S0007 ▲	8.00"	6.00"	9.75"	1.90	12	76.35
S0009 ▲	10.00"	5.75"	9.75"	2.20	12	84.95
S0010 ▲	12.00"	0.50"	3.125"	1.40	12	81.20
S0011 ▲	12.00"	6.00"	9.75"	1.64	12	87.30

MULTI-BEND SPOUTS



Model Number	Reach	Base to Aerator**	Overall Height	Weight Each Pounds	Case Quantity	List Price
S0012 ▲	18.00"	3.75"	7.75"	2.40	12	165.90

GOOSENECK SPOUTS



S0030



S0070

Model Number	Reach	Base to Aerator**	Overall Height	Weight Each Pounds	Case Quantity	List Price
S0020 ▲	3.625"	6.25"	8.75"	1.47	12	75.25
S0030 ▲	5.25"	5.50"	10.00"	1.55	12	83.40
S0050 ▲	8.00"	6.125"	11.375"	1.65	12	93.85
S0070 ▲	9.50"	6.50"	9.175"	1.81	12	96.55

SMOOTH-END GOOSENECK SPOUTS



Model Number	Reach	Base to Aerator**	Overall Height	Weight Each Pounds	Case Quantity	List Price
S0030NA ▲	5.25"	N/A	10.00"	1.15	6	83.40

VACUUM-BREAKER SPOUTS



Model Number	Reach	Base to Aerator**	Overall Height	Weight Each Pounds	Case Quantity	List Price
SV003 ■	6.00"	5.75"	10.50"	2.15	12	161.75
SV006 ■	8.00"	0.50"	4.00"	1.40	12	148.35
SV010 ■	12.00"	0.50"	4.00"	1.70	12	172.40

LAMINAR FLOW KITS

Model Number	Description	List Price
52655	Laminar flow spout, flow control in base spout, 0.5 gpm/1.9 lpm	18.35
52652	Laminar flow spout, flow control in base spout, 1.5 gpm/5.7 lpm	18.35
52653	Laminar flow spout, flow control in base spout, 1.0 gpm/3.8 lpm	17.50

All spouts include 2.2 gpm [8.3 lpm] max. aerators.

Spouts are designed for use only with the 8100 and 8200 series.

*Ceramic Disc Cartridges (52000 Hot; 52001 Cold) **Height from spout nut base plane to aerator

▲ NSF 6 1/9 and 372 compliant ■ Non-drinking water faucet

♻️ ADA compliant ♻️ WaterSense® ♻️ Water-saving

M•PRESS™ Heavy-Duty Metering Faucets



M•PRESS™ Single-Mount Metering Faucet / 8884 Series

M•PRESS™ Heavy-Duty Metering Faucets

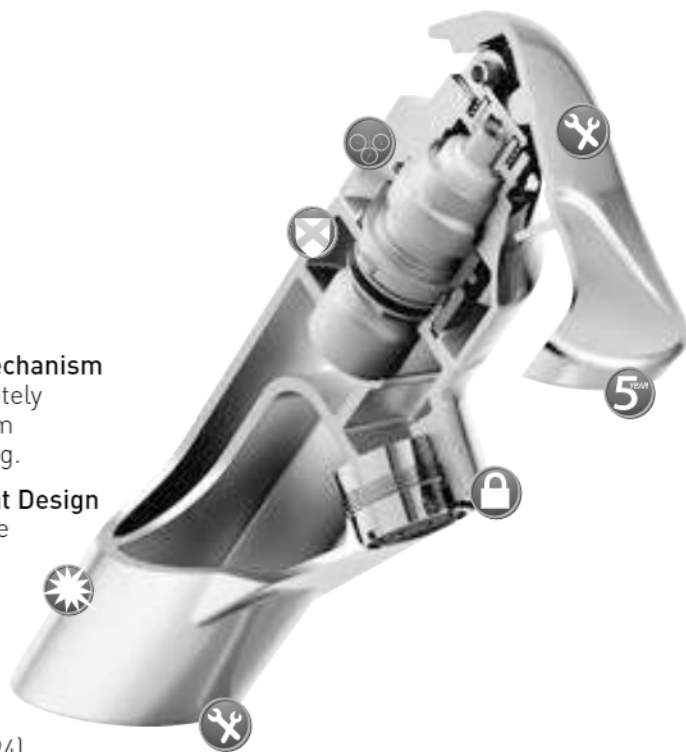

Consistent Timing: Sealed Silicone Timing Mechanism

The sealed silicone timing mechanism is completely separated from the water source—protected from impurities and clogs—to ensure consistent timing.



Reliable Performance: Pressure-Independent Design

Even if pressure varies, you get consistent handle feel, reliable timing and proper shutoff with every use.



Secure Installation: Anti-Rotation Handle and Deckplate

Interlocking design ensures the handle will never rotate. Optional anti-rotation deckplates are available for single-mount models (8884, 8894).



Vandal-Resistant Operation: Recessed Aerator

Unique, recessed design protects aerator from tampering and damage.



Superior Durability: Heavy-Duty Construction

Solid cast brass body and a finish that resists harsh chemical cleaners.



Worry-Free Quality:

Best-in-Class Five-Year Limited Warranty







Versatile Interchangeability: Manual-to-Metering Conversion Kit

Convert any M•DURA™ 8200 series* faucet to an M•PRESS™ metering faucet with a simple cartridge and handle conversion kit.

* Excludes 8242, 8244, 8281, 8286 and Modern Lavs

















COMMERCIAL

	MODEL NUMBER	LIST PRICE	CASE QTY
ECO-PERFORMANCE SINGLE-MOUNT METERING FAUCET*			
 <ul style="list-style-type: none"> • Single-mount • Cast brass • Timing preset to 10 seconds • Adjustable timing cycle • 0.5 gpm [1.9 lpm] max. vandal-resistant multi-stream laminar flow • Max 0.25 gpc [.95 lpc] @ 30 seconds • ½" IPS connections • Without drain   	8884	232.75	6
<ul style="list-style-type: none"> • 4" optional deckplate • Anti-rotation (for use with 8161 or 8884 only) 	9950	36.60	12

*Durameter™ Cartridge

● NSF 372 compliant  ADA compliant  Water-saving

M•PRESS™ Heavy-Duty Metering Faucets

	MODEL NUMBER	LIST PRICE	CASE QTY
ECO-PERFORMANCE CENTRESET METERING FAUCET*			
 <ul style="list-style-type: none"> • 4" centreset • Cast brass • Timing preset to 10 seconds • Adjustable timing cycle • 0.5 gpm [1.9 lpm] max. vandal-resistant multi-stream laminar flow • Max. 0.25 gpc [.95 lpc] @ 30 seconds • ½" IPS connections • Without drain   	8886	412.50	6
ECO-PERFORMANCE WIDESPREAD METERING FAUCET*			
 <ul style="list-style-type: none"> • 8" widespread • Cast brass • Timing preset to 10 seconds • Adjustable timing cycle • 0.5 gpm [1.9 lpm] max. vandal-resistant multi-stream laminar flow • Max. 0.25 gpc [.95 lpc] @ 30 seconds • ½" IPS connections • Without drain   	8889	496.20	6
ECO-PERFORMANCE SINGLE-MOUNT METERING FAUCET*			
 <ul style="list-style-type: none"> • Single-mount • Cast brass • Extended reach • Timing preset to 10 seconds • Adjustable timing cycle • 0.5 gpm [1.9 lpm] max. vandal-resistant multi-stream laminar flow • Max. 0.25 gpc [.95 lpc] @ 30 seconds • ½" IPS connections • Without drain   	8894	275.25	6
 <ul style="list-style-type: none"> • 4" optional anti-rotation deckplate (for use with 8894 model)   	99551	37.30	12

*Durameter™ Cartridge

 NSF 372 compliant
  ADA compliant
  Water-saving

M•PRESS™ Heavy-Duty Metering Faucets

	MODEL NUMBER	LIST PRICE	CASE QTY
--	--------------	------------	----------

DURAMETER CARTRIDGE*

- Durameter™ replacement metering cartridge

52100

138.50

24

MANUAL-TO-METERING CONVERSION KIT*

Manual-to-metering conversion kit.
Convert any M•DURA™ 8200 series faucet† to an M•PRESS™ metering faucet with a simple cartridge and handle change.

52120

312.35

12

- Includes hot/cold colour indicator rings
- Excludes 8242, 8244 and modern lavs

COMMERCIAL

*Durameter™ Cartridge

● NSF 372 compliant ♿ ADA compliant ♻️ Water-saving







M•BITION™ Medium-Duty Faucets













M•BITION™ Single-Handle Lavatory Faucet / 8430 Series









M•BITION™ Medium-Duty Lavatory Faucets



-  **Safe Operation: Temperature Control**
Adjustable temperature limit stop with durable brass construction.
-  **Superior Durability: 1255® Duralast® Cartridge**
Proprietary ceramic-disc design for smooth feel and reliable operation.
-  **Easy to Install: Supply Line Options**
Choose from standard copper or flexible supply lines.
-  **ADA Compliant: Lever Handle**
Features embedded hot/cold indicators that won't wear off.
-  **Vandal-Resistant: Recessed Aerator**
Unique, recessed design protects aerator from tampering and damage.
-  **Worry-Free Quality:**
Best-in-Class Five-Year Limited Warranty



COMMERCIAL





	MODEL NUMBER	LIST PRICE	CASE QTY
MODERN SUITE LAVATORY FAUCET*			
 <ul style="list-style-type: none"> • Single-mount • 3-1/8" lever handle • 1.2 gpm [4.5 lpm] max. vandal-resistant aerator • 3/8" compression connections • Flexible supply lines • Without drain    	9480	216.25	3
 <ul style="list-style-type: none"> • Metal drain included    	9482	239.60	3
<ul style="list-style-type: none"> • 4" optional deckplate 	99559	39.75	20



WIDESPREAD LAVATORY FAUCET**			
 <ul style="list-style-type: none"> • Widespread • 3" lever handles • 1.2 gpm [4.5 lpm] max. vandal-resistant aerator • 1/2" IPS connections • Without drain    	9921	321.20	3
<ul style="list-style-type: none"> • Metal drain included    	9922	361.15	3

*1255® Duralast® Cartridge **1234® Duralast® Cartridge

M•BITION™ Medium-Duty Lavatory Faucets

	MODEL NUMBER	LIST PRICE	CASE QTY	
SINGLE-HANDLE LAVATORY FAUCET*				
	<ul style="list-style-type: none"> • 4" centreset • 4" lever handle • 1.2 gpm [4.5 lpm] max. vandal-resistant aerator • Flexible supply lines with 3/8" connections • Without drain • Removable plug button in lift rod hole • Brass adjustable temperature limit stop 	8422	232.70	12
	 <p>Chrome</p>	<ul style="list-style-type: none"> • 0.5 gpm [1.9 lpm] max. vandal-resistant aerator • Flexible supply lines with 3/8" connections 	8422F05	232.70

SINGLE-HANDLE LAVATORY FAUCET*				
	<ul style="list-style-type: none"> • 4" centreset • 3" lever handle • 1.2 gpm [4.5 lpm] max. vandal-resistant aerator • 1/2" IPS connections • Without drain • Removable plug button in lift rod hole • Brass adjustable temperature limit stop 	8430	177.00	12
	 <p>Chrome</p>  <p>Classic Brushed Nickel</p>	<ul style="list-style-type: none"> • 0.5 gpm [1.9 lpm] max. vandal resistant aerator 	8430CBN	221.85
	<ul style="list-style-type: none"> • 1.2 gpm [4.5 lpm] max. vandal-resistant aerator • Flexible supply lines with 3/8" connections • With metal drain 	8437CBN	298.35	-









CENTRESET LAVATORY FAUCET**				
	<ul style="list-style-type: none"> • 4" centreset • 4" wrist blade handles • 1.2 gpm [4.5 lpm] max. aerator • 1/2" IPS connections • Without drain • Removable plug button in lift rod hole 	8800	210.05	6
	 <p>Classic Brushed Nickel available on select models ending in CBN.</p>	<ul style="list-style-type: none"> • 0.5 gpm [1.9 lpm] max. aerator 	8800F05	210.05

*Ceramic Disc Cartridges (52000 Hot; 52001 Cold)

▲ NSF 6 1/9 and 372 compliant ♿ ADA compliant ♻️ WaterSense® 🌿 Water-saving

COMMERCIAL

M•BITION™ Medium-Duty Kitchen Faucets

	MODEL NUMBER	LIST PRICE	CASE QTY
KITCHEN FAUCET*			
 <ul style="list-style-type: none"> • Deckmount • 2½" lever handles • 1.5 gpm [5.7 lpm] max. aerator • 9" spout reach • ½" IPS connections   	8780	163.65	6
KITCHEN FAUCET*			
 <ul style="list-style-type: none"> • Deckmount • 4" wrist blade handles • 1.5 gpm [5.7 lpm] max. aerator • 9" spout reach • ½" IPS connections   	8798	256.10	6

COMMERCIAL

*Washerless Cartridges (1224)

▲ NSF 6 1/9 and 372 compliant ♿ ADA compliant 💧 Water-saving

M•BITION™ Medium-Duty Kitchen Faucets

	MODEL NUMBER	LIST PRICE	CASE QTY
--	--------------	------------	----------

KITCHEN FAUCET*



- Deckmount
- 2½" lever handles
- 1.5 gpm [5.7 lpm] max. aerator
- 12 5/8" high-arc spout
- 8½" spout reach
- ½" IPS connections
- Chrome side spray



8792 293.30 6

KITCHEN FAUCET*



- Deckmount
- 4" wrist blade handles
- 1.5 gpm [5.7 lpm] max. aerator
- 11 3/8" high-arc spout
- 8½" spout reach
- ½" IPS connections











8799 321.10 6

COMMERCIAL

*Washerless Cartridges (1224)









▲ NSF 6 1/9 and 372 compliant ♿ ADA compliant ♻ Water-saving

M•BITION™ Medium-Duty Bar Faucets

		MODEL NUMBER	LIST PRICE	CASE QTY
BAR/PANTRY FAUCET*				
	<ul style="list-style-type: none"> • 4" centreset • 4" wrist blade handles • 1.2 gpm [4.5 lpm] max. aerator • 4 9/16" spout reach • ½" IPS connections 	8938	222.90	6
	  			
BAR/PANTRY FAUCET*				
	<ul style="list-style-type: none"> • 4" centreset • 2½" lever handles • 1.2 gpm [4.5 lpm] max. aerator • 4 9/16" spout reach • ½" IPS connections 	8957	183.15	12
	  			

COMMERCIAL

M•BITION™ Medium-Duty Bar Faucets

		MODEL NUMBER	LIST PRICE	CASE QTY
BAR/PANTRY FAUCET*				
	<ul style="list-style-type: none"> • 4" centreset • 4" wrist blade handles • 1.2 gpm [4.5 lpm] max. aerator • 4 ¾" spout reach • ½" IPS connections 	8948	208.20	6
	  			
BAR/PANTRY FAUCET*				
	<ul style="list-style-type: none"> • 4" centreset • 4" wrist blade handles • 1.2 gpm [4.5 lpm] max. aerator • 11 ½" high-arc spout • 8 ½" spout reach • ½" IPS connections 	8940	286.60	6
	  			

COMMERCIAL

*Washerless Cartridges (1224)

▲ NSF 6 1/9 and 372 compliant  ADA compliant  Water-saving

M•POWER™ Below-Deck Sensor-Operated Faucets & Soap Dispensers



Align® Below-Deck Sensor-Operated Modern Faucet / 8559

Align® Below-Deck Sensor-Operated Modern Soap Dispenser / 8560

M•POWER™ Sensor-Operated Faucets

		MODEL NUMBER	LIST PRICE	CASE QTY
ALIGN® BELOW-DECK SENSOR-OPERATED MODERN FAUCET				
	<ul style="list-style-type: none"> • connection: 3/8" compression • vandal resistant: yes • power source: 4 AA included with optional AC* • flow type: vandal resist multi-laminar • water usage: 0.5 gpm (1.9 L/min) max. • mount type: single mount • supply length: 24" • non-mixing: yes • drain assembly: drain not included • material: brass 	8559	840.05	6
		4" DECKPLATE SOLD SEPARATELY		
		182546	43.65	12
		8" DECKPLATE SOLD SEPARATELY		
		99558	71.55	20
	  			
ALIGN® BELOW-DECK SENSOR-OPERATED MODERN SOAP DISPENSER				
	<ul style="list-style-type: none"> • easily refillable 1500ml foam soap reservoir included • material: brass 	8560	672.40	3
		BRASS SPACER SOLD SEPARATELY		
		181149	101.75	12
				
BELOW-DECK SENSOR-OPERATED CENTERSET FAUCET				
	<ul style="list-style-type: none"> • connection: 3/8" compression • vandal resistant: yes • power source: 4 AA included with optional AC* • flow type: vandal resist multi-laminar • water usage: 0.5 gpm (1.9 L/min) max. • mount type: centerset • supply length: 24" • non-mixing: yes • drain assembly: drain not included • material: brass 	CA8301	845.85	6
	  			
BELOW-DECK SENSOR-OPERATED TRANSITIONAL FAUCET				
	<ul style="list-style-type: none"> • connection: 3/8" compression • vandal resistant: yes • power source: 4 AA included with optional AC* • flow type: vandal resist multi-laminar • water usage: 0.5 gpm (1.9 L/min) max. • mount type: single mount • supply length: 24" • non-mixing: yes • drain assembly: drain not included • LEED: yes • material: brass 	CA8302	840.05	6
		4" DECKPLATE SOLD SEPARATELY		
		182546	43.65	12
		8" DECKPLATE SOLD SEPARATELY		
		99558	71.55	20
	  			
BELOW-DECK SENSOR-OPERATED TRANSITIONAL SOAP DISPENSER				
	<ul style="list-style-type: none"> • easily refillable 1500ml foam soap reservoir included • material: brass 	8558	672.40	3
		BRASS SPACER SOLD SEPARATELY		
		181148	109.45	12
				

*Convert to AC power with the following accessories: for single or multi-unit AC applications, order one (1) multi-unit transformer (104630) powers up to (8) units, and one (1) faucet AC connector (182538) per unit.

M•POWER™ Sensor-Operated Faucets

BELOW-DECK SENSOR-OPERATED GOOSENECK MIXING FAUCET



- connection: 3/8" compression
- power source: 4 AA included with optional AC*
- flow type: multi-stream laminar
- water usage: 0.5 gpm (1.9 L/min) max.
- mount type: single mount
- supply length: 24"
- drain assembly: drain not included
- handle type: lever
- material: brass



MODEL NUMBER	LIST PRICE	CASE QTY
8562	1,031.00	3
4" DECKPLATE SOLD SEPARATELY		
182546	43.65	12
8" DECKPLATE SOLD SEPARATELY		
99558	71.55	20

BELOW-DECK SENSOR-OPERATED GOOSENECK FAUCET



- connection: 3/8" compression
- vandal resistant: yes
- power source: 4 AA included with optional AC*
- flow type: vandal resist multi-laminar
- water usage: 0.5 gpm (1.9 L/min) max.
- mount type: single mount
- supply length: 24"
- non-mixing: yes
- drain assembly: drain not included
- material: brass



CA8303	891.40	6
4" DECKPLATE SOLD SEPARATELY		
182546	43.65	12
8" DECKPLATE SOLD SEPARATELY		
99558	71.55	20

BELOW-DECK SENSOR-OPERATED GOOSENECK FAUCET WITHOUT SPOUT



- connection: 3/8" compression
- vandal resistant: yes
- power source: 4 AA included with optional AC*
- sold without spout: yes
- mount type: single mount
- supply length: 24"
- non-mixing: yes
- drain assembly: drain not included
- material: brass
- spout: not included



8565	820.80	3
4" DECKPLATE SOLD SEPARATELY		
182546	43.65	12
8" DECKPLATE SOLD SEPARATELY		
99558	71.55	20

COMMERCIAL

*Convert to AC power with the following accessories: for single or multi-unit AC applications, order one (1) multi-unit transformer (104630) powers up to (8) units, and one (1) faucet AC connector (182538) per unit.

M•POWER™ Above-Deck Sensor-Operated Faucets



M•POWER™ Above-Deck Sensor-Operated Lavatory Faucet / 8551 Series

M•POWER™ Sensor-Operated Faucets

ABOVE-DECK SENSOR-OPERATED MODERN FAUCET



- connection: 3/8" compression
- vandal resistant: yes
- power source: battery-powered (4 AA included)
- flow type: vandal resist multi-laminar
- water usage: 0.5 gpm (1.9 L/min) max.
- mount type: single mount
- supply length: 24"
- non-mixing: yes
- drain assembly: drain not included



MODEL NUMBER	LIST PRICE	CASE QTY
8551	784.15	6
4" DECKPLATE SOLD SEPARATELY		
99556	55.50	20
8" DECKPLATE SOLD SEPARATELY		
99558	71.55	20

AC ABOVE-DECK SENSOR-OPERATED MODERN FAUCET



- connection: 3/8" compression
- vandal resistant: yes
- power source: ac powered
- flow type: vandal resist multi-laminar
- water usage: 0.5 gpm (1.9 L/min) max.
- mount type: single mount
- supply length: 24"
- non-mixing: yes
- drain assembly: drain not included



8551AC	845.70	6
4" DECKPLATE SOLD SEPARATELY		
99556	55.50	20
8" DECKPLATE SOLD SEPARATELY		
99558	71.55	20

ABOVE-DECK SENSOR-OPERATED MODERN MIXING FAUCET



- connection: 3/8" compression
- vandal resistant: yes
- power source: battery-powered (4 AA included)
- flow type: vandal resist multi-laminar
- water usage: 0.5 gpm (1.9 L/min) max.
- mount type: single mount
- supply length: 24"
- temperature & manual override: yes
- drain assembly: drain not included
- handle type: lever



8552	923.75	6
4" DECKPLATE SOLD SEPARATELY		
99556	55.50	20
8" DECKPLATE SOLD SEPARATELY		
99558	71.55	20

AC ABOVE-DECK SENSOR-OPERATED MODERN MIXING FAUCET



- connection: 3/8" compression
- vandal resistant: yes
- power source: ac powered
- flow type: vandal resist multi-laminar
- water usage: 0.5 gpm (1.9 L/min) max.
- mount type: single mount
- supply length: 24"
- temperature & manual override: yes
- drain assembly: drain not included
- handle type: lever



8552AC	992.65	6
4" DECKPLATE SOLD SEPARATELY		
99556	55.50	20
8" DECKPLATE SOLD SEPARATELY		
99558	71.55	20

COMMERCIAL

For single or multi-unit AC applications, order one (1) multi-unit transformer (104630) powers up to (8) units

M•POWER™ Sensor-Operated Faucets

MODEL NUMBER	LIST PRICE	CASE QTY
--------------	------------	----------

ABOVE-DECK SENSOR-OPERATED TRANSITIONAL FAUCET



- connection: 3/8" compression
- vandal resistant: yes
- power source: battery-powered (4 AA included)
- flow type: vandal resist multi-laminar
- water usage: 0.5 gpm (1.9 L/min) max.
- mount type: single mount
- supply length: 24"
- non-mixing: yes
- drain assembly: drain not included

8553	784.15	6
<u>4" DECKPLATE SOLD SEPARATELY</u>		
99557	55.50	20
<u>8" DECKPLATE SOLD SEPARATELY</u>		
99558	71.55	20



AC ABOVE-DECK SENSOR-OPERATED TRANSITIONAL FAUCET



- connection: 3/8" compression
- vandal resistant: yes
- power source: ac powered
- flow type: vandal resist multi-laminar
- water usage: 0.5 gpm (1.9 L/min) max.
- mount type: single mount
- supply length: 24"
- non-mixing: yes
- drain assembly: drain not included

8553AC	845.70	6
<u>4" DECKPLATE SOLD SEPARATELY</u>		
99557	55.50	20
<u>8" DECKPLATE SOLD SEPARATELY</u>		
99558	71.55	20



ABOVE-DECK SENSOR-OPERATED TRANSITIONAL MIXING FAUCET



- connection: 3/8" compression
- vandal resistant: yes
- power source: battery-powered (4 AA included)
- flow type: vandal resist multi-laminar
- water usage: 0.5 gpm (1.9 L/min) max.
- mount type: single mount
- supply length: 24"
- temperature & manual override: yes
- drain assembly: drain not included
- handle type: lever

8554	923.75	6
<u>4" DECKPLATE SOLD SEPARATELY</u>		
99557	55.50	20
<u>8" DECKPLATE SOLD SEPARATELY</u>		
99558	71.55	20



AC ABOVE-DECK SENSOR-OPERATED TRANSITIONAL MIXING FAUCET



- connection: 3/8" compression
- vandal resistant: yes
- power source: ac powered
- flow type: vandal resist multi-laminar
- water usage: 0.5 gpm (1.9 L/min) max.
- mount type: single mount
- supply length: 24"
- temperature & manual override: yes
- drain assembly: drain not included
- handle type: lever

8554AC	992.65	6
<u>4" DECKPLATE SOLD SEPARATELY</u>		
99557	55.50	20
<u>8" DECKPLATE SOLD SEPARATELY</u>		
99558	71.55	20



For single or multi-unit AC applications, order one (1) multi-unit transformer (104630) powers up to (8) units

M•POWER™ Sensor-Operated Faucets

	MODEL NUMBER	LIST PRICE	CASE QTY
LOW-FLOW THERMOSTATIC MIXING VALVE			



- connection: 1/2" female thread; IPS
- includes: 3/8" compression adapters
- no of ports: three
- water usage: 0.35 gpm min. (1.32 L/min.)
- listed to ASSE1070

104451

223.55

12

LOW-FLOW THERMOSTATIC MIXING VALVE



- Stainless steel box and cover with vandal resistant screws
- Thermostatic mixing valve, with adjustable temperature control cartridge
- 1/2" copper connections
- 1/4 turn stops
- Hot and cold check valves prevent possible backflow on water supply inlets
- Stainless steel internal strainer protects against line trash
- Listed to ASSE standard 1070
- Lavatory faucet application
- Min flow rate at 45 psi = 0.35gpm (1.3 lpm)

15440

688.00

2

See page 418 for sensor-operated faucet accessories.

COMMERCIAL

M•POWER™ Sensor-Operated Faucets**SENSOR-OPERATED FAUCET ACCESSORIES**

Part No.	Description	List Price
104424	Chrome Mixing Valve, Includes Integral Check Valves	144.00
174055	Battery Housing for Above and Below-Deck Models	38.00
174056	Solenoid Repair Kit for All Above-Deck SKUs 8551, 8552, 8553, 8554, 8551AC, 8552AC, 8553AC, 8554AC	109.80
174057	Strain Relief and Sensor Cable Extension for 8551-8554	36.20
174060	Mounting Hardware for All Above-Deck SKUs 8551, 8552, 8553, 8554, 8551AC, 8552AC, 8553AC, 8554AC	22.65
174061	Manual Temperature Control Handle Kit 8552, 8554, 8552AC, 8554AC	37.35
174062	T10 Torx Key and Screw for All Above-Deck SKUs 8551, 8552, 8553, 8554, 8551AC, 8552AC, 8553AC, 8554AC	22.05
174065	In-Line Filter with Check Valve for All Above-Deck SKUs 8551, 8552, 8553, 8554, 8551AC, 8552AC, 8553AC, 8554AC	59.45
174066	Filter Screen for Filter Housing for All Above-Deck SKUs 8551, 8552, 8553, 8554, 8551AC, 8552AC, 8553AC, 8554AC	10.80
174335	Sensor and Bracket for 8553, 8554, 8553AC, 8554AC	248.05
174336	Override Plug Button for 8552, 8552AC	25.20
174337	Override Plug Button for 8554, 8554AC	25.20
99556	4" Deckplate designed for 8551, 8551AC, 8552, 8552AC	55.50
99557	4" Deckplate designed for 8553, 8553AC, 8554, 8554AC	55.50
99558	8" Deckplate for 8559, CA8302, 8562, CA8303, 8565, 8551, 8551AC, 8552, 8552AC, 8553, 8553AC, 8554, 8554AC	71.55
52016F05	0.5 gpm Multi-Stream Laminar Flow Aerator	16.45
52016F10	1.0 gpm Aerator	16.45
S0030NA	Smooth-End Spout with 1.5 gpm Laminar Flow Base Insert	83.40
104630	Multi-Unit AC Transformer (powers up to 8 units)	119.55
182534	Control Box for Gooseneck and Above-Deck AC Models	75.30
182535	Control Box for CA83021, 8559, CA8302	214.25
182536	Control Box Wall Mounting Hardware	12.75
182537	IR Sensor Assembly and Bracket for Below-Deck Models	223.25
182538	AC Connector	29.95
182539	36" Cable for Gooseneck Models	59.20
182540	Cable Harness and Vandal Sleeve for Below-Deck Non-Mixing Models	68.00
182542	Centerset Deck Gasket for CA8301	23.25
182543	Transitional Deck Gasket for CA8302	23.10
182544	Modern Deck Gasket for 8559	23.10
182547	Override Plug Button	35.45
182546	4" Deckplate for 8559, CA8302, 8562, CA8303, 8565	43.65
Sensor-Operated Soap Dispenser Accessories		
182413	Non-Drip Foam Soap Pump	87.05
182414	1500mL Foam Soap Bottle	24.60
182415	Control Box for Sensor Soap	179.50
182416	Mounting Bracket, Vandal Shield and Mounting Hardware for Sensor Soap	133.25
182417	Soap Tube, O-Ring, Spout Barb and Soap Net	73.25
182418	Soap Net	45.80
182419	Vandal Sheathing for Sensor Soap	22.25
182420	Wire Vandal Sheathing for Sensor Soap	58.30
182421	D-Cell Battery Box for Sensor Soap	84.60
182422	Sensor, Bracket and Screw for Sensor Soap	208.20
182423	Mounting Hardware for Sensor Soap	18.00
181148	Transitional Deck Spacer for 8558	109.45
181149	Modern Deck Spacer for 8560	101.75

M•POWER™ Sensor-Operated Flush Valves



M•POWER™ Sensor-Operated Flush Valves

MODEL NUMBER LIST PRICE CASE QTY

1-1/2" DC SENSOR-OPERATED CLOSET FLUSH VALVE



- flush valve type: water closet
- GPF: 3.5 GPF (13.0LPF)
- vandal resistant: yes
- battery-powered (4 AA included)
- flush valve technology: accuset piston
- material: cast brass
- easy front battery access: yes
- mechanical override: yes

8310S35 853.05 3



- GPF: 1.6 GPF (6.0 LPF)

8310 853.05 4



- GPF: 1.28 GPF (4.8 LPF)

8311 853.05 4



- GPF: 1.0/1.6 GPF (3.8/6.0 LPF)
- dual flush

8310DF16 895.75 4



1-1/2" AC SENSOR-OPERATED CLOSET FLUSH VALVE



- flush valve type: water closet
- GPF: 1.6 GPF (6.0 LPF)
- vandal resistant: yes
- ac powered
- requires 12v transformer: sold separately
- flush valve technology: accuset piston
- material: cast brass
- easy front battery access: yes
- mechanical override: yes

8310AC16 853.05 4



- GPF: 1.28 GPF (4.8 LPF)

8311AC12 853.05 4



- GPF: 1.0/1.6 GPF (3.8/6.0 LPF)
- dual flush

8310ACDF16 895.75 4



3/4" DC SENSOR-OPERATED URINAL FLUSH VALVE



- flush valve type: urinal
- GPF: 1.0 GPF (3.8LPF)
- vandal resistant: yes
- battery-powered (4 AA included)
- flush valve technology: accuset piston
- material: cast brass
- easy front battery access: yes
- mechanical override: yes

8312 853.05 4



- GPF: 0.5 GPF (1.9 LPF)

8315 853.05 4



- GPF: 0.125 GPF (0.5 LPF)

8316 853.05 4



For single or multi-unit AC applications, order one (1) multi-unit transformer (104630) powers up to (8) units.

M•POWER™ Sensor-Operated Flush Valves

	MODEL NUMBER	LIST PRICE	CASE QTY
--	--------------	------------	----------

1-1/4" DC SENSOR-OPERATED URINAL FLUSH VALVE



- flush valve type: urinal
- GPF: 1.0 GPF (3.8LPF)
- vandal resistant: yes
- battery-powered (4 AA included)
- flush valve technology: accuset piston
- material: cast brass
- easy front battery access: yes
- mechanical override: yes



8314 853.05 6

3/4" AC SENSOR-OPERATED URINAL FLUSH VALVE



- flush valve type: urinal
- GPF: 1.0 GPF (3.8LPF)
- vandal resistant: yes
- ac powered
- requires 12v transformer: sold separately
- flush valve technology: accuset piston
- material: cast brass
- easy front battery access: yes
- mechanical override: yes



8312AC10 853.05 4

• GPF: 0.5 GPF (1.9 LPF) **8315AC05** 853.05 4



• GPF: 0.125 GPF (0.5 LPF) **8316AC** 853.05 4



COMMERCIAL

For single or multi-unit AC applications, order one (1) multi-unit transformer (104630) powers up to (8) units.

M•POWER™ Sensor-Operated Flush Valves

	MODEL NUMBER	LIST PRICE	CASE QTY	
DC SENSOR-OPERATED CLOSET FLUSH VALVE RETROFIT KIT				
	<ul style="list-style-type: none"> flush valve type: water closet retro fit GPF: 1.6 GPF (6.0 LPF) vandal resistant: yes battery-powered (4 AA included) flush valve technology: accuset piston material: cast brass easy front battery access: yes mechanical override: yes 	8310R16	764.25	8
	<ul style="list-style-type: none"> GPF: 1.28 GPF (4.8 LPF) 	8310SR128	764.25	3
	<ul style="list-style-type: none"> GPF: 1.0/1.6 GPF (3.8/6.0 LPF) dual flush 	8310RDF16	806.95	4
DC SENSOR-OPERATED URINAL FLUSH VALVE RETROFIT KIT				
	<ul style="list-style-type: none"> flush valve type: urinal retro fit GPF: 1.0 GPF (3.8LPF) vandal resistant: yes battery-powered (4 AA included) flush valve technology: accuset piston material: cast brass easy front battery access: yes mechanical override: yes 	8312R10	764.25	8
	<ul style="list-style-type: none"> GPF: 0.5 GPF (1.9 LPF) 	8312SR05	764.25	3
	<ul style="list-style-type: none"> GPF: 0.125 GPF (0.5 LPF) 	8312SR125	764.25	3

COMMERCIAL

For single or multi-unit AC applications, order one (1) multi-unit transformer (104630) powers up to (8) units.

M•POWER™ Sensor-Operated Flush Valves

SENSOR-OPERATED FLUSH VALVE ACCESSORIES		MODEL NUMBER	LIST PRICE	CASE QTY
Part No.	Description		List Price	
104585	1½" Flush Extension Tube-24"		140.70	
104587	Flush Valve Trap Primer		211.15	
104588	1" Sweat Kit, Flush Valve		36.50	
104589	1" Sweat Kit, Flush Valve 6" Long		50.75	
104555	1" Angle Stop Valve Flush Valve		130.80	
104556	¾" Angle Stop Valve Flush Valve		130.80	
104570	Vacuum Breaker Kit		22.05	
104571	Brass Valve Body Nut Flush Valve		29.45	
104578	1½" Brass Flush Valve Tube		49.25	
104579	1¼" Brass Flush Tube		49.25	
104580	¾" Brass Flush Tube		48.30	
104581	1½" Top Spud Assembly		49.25	
104582	1¼" Top Spud Assembly		46.40	
104583	¾" Top Spud Assembly		40.60	
104584	Urinal Tailpiece (24" x ¾")		108.95	
104617	Flush Valve Battery Pack		42.35	
104618	Front Shroud 1.6gpf		100.30	
104619	Front Shroud 1.28gpf		100.30	
104620	Front Shroud 3.5gpf		100.30	
104621	Front Shroud 1.0gpf		100.30	
104622	Front Shroud 0.5gpf		100.30	
104623	Front Shroud 1.0/1.6gpf		100.30	
104624	Front Shroud 0.125gpf		100.30	
104625	Rear shroud DC		47.20	
104626	Rear shroud AC		48.50	
104627	Flush Valve Override Assembly		45.10	
104628	Piston and Manifold Tool		95.10	
104630	Multi-Unit AC Transformer (powers up to 8 units)		119.55	
104631	AC Cover Tube and Escutcheon		45.20	
104633	Solenoid Manifold and Tool		145.60	
104634	Flush Valve Override Cap		31.85	

M•DURA™ Heavy-Duty Manual Flush Valves





M•DURA™ Heavy-Duty Manual Urinal Flush Valve / 8312M Series

M•DURA™ Heavy-Duty Manual Flush Valves

1-1/2" MANUAL CLOSET FLUSH VALVE



	MODEL NUMBER	LIST PRICE	CASE QTY
<ul style="list-style-type: none"> flush valve type: water closet GPF: 3.5 GPF (13.0LPF) flush valve technology: accuset piston material: cast brass 	8310M35	258.10 Chrome	3
<ul style="list-style-type: none"> GPF: 1.6 GPF (6.0 LPF) 	8310M16	258.10 Chrome	3
<ul style="list-style-type: none"> GPF: 1.28 GPF (4.8 LPF)   	8310M128	258.10 Chrome	3

3/4" MANUAL URINAL FLUSH VALVE



<ul style="list-style-type: none"> flush valve type: urinal GPF: 1.0 gpm (3.8L/min) flush valve technology: accuset piston material: cast brass 	8312M10	258.10 Chrome	3
<ul style="list-style-type: none"> GPF: 0.5 GPF (1.9 LPF)   	8312M05	258.10 Chrome	3
<ul style="list-style-type: none"> GPF: 0.125 GPF (0.5 LPF)   	8312M0125	258.10 Chrome	3

1-1/4" MANUAL URINAL FLUSH VALVE



<ul style="list-style-type: none"> flush valve type: urinal GPF: 1.0 GPF (3.8LPF) flush valve technology: accuset piston material: cast brass 	8314M10	258.10 Chrome	3
---	----------------	---------------	---

COMMERCIAL

M•DURA™ Heavy-Duty Manual Flush Valves

		MODEL NUMBER	LIST PRICE	CASE QTY
MANUAL CLOSET FLUSH VALVE RETROFIT KIT				
	<ul style="list-style-type: none"> flush valve type: water closet retro fit GPF: 3.5 GPF (13.0LPF) flush valve technology: accuset piston material: cast brass 	8310MR35	209.95 Chrome	6
	<ul style="list-style-type: none"> GPF: 1.6 GPF (6.0 LPF) 	8310MR16	209.95 Chrome	6
	<ul style="list-style-type: none"> GPF: 1.28 GPF (4.8 LPF) 	8310MR128	209.95 Chrome	6
	<ul style="list-style-type: none"> ADA compliant WaterSense Water-saving 			
MANUAL URINAL FLUSH VALVE RETROFIT KIT				
	<ul style="list-style-type: none"> flush valve type: urinal retro fit GPF: 1.0 GPF (3.8LPF) flush valve technology: accuset piston material: cast brass 	8312MR10	209.95 Chrome	6
	<ul style="list-style-type: none"> GPF: 0.5 GPF (1.9 LPF) 	8312MR05	209.95 Chrome	6
	<ul style="list-style-type: none"> GPF: 0.125 GPF (0.5 LPF) 	8312MR0125	209.95 Chrome	6
	<ul style="list-style-type: none"> ADA compliant WaterSense Water-saving 			
1-1/2" MANUAL CLOSET FLUSH VALVE WITH BEDPAN WASHER				
	<ul style="list-style-type: none"> flush valve type: water closet GPF: 3.5 GPF (13.0LPF) flush valve technology: accuset piston material: cast brass 	8310BPW35	769.15 Chrome	2
	<ul style="list-style-type: none"> GPF: 1.6 GPF (6.0 LPF) 	8310BPW16	769.15 Chrome	2
BEDPAN WASHER DIVERTER KIT				
	<ul style="list-style-type: none"> flush valve type: bedpan washer diverter kit flush valve technology: accuset piston material: solid brass 	8310BPWR	555.00 Chrome	3

COMMERCIAL

M•DURA™ Heavy-Duty Manual Flush Valves

MANUAL FLUSH VALVE ACCESSORIES

Part No.	Description	List Price
104540	M•DURA™ 2 1/4" Extension (standard) Nipple (compatible with Delany angle stops)	44.35
104541	M•DURA™ 1 3/4" Extension Nipple (compatible with Delany angle stops)	46.70
104542	M•DURA™ 2 3/4" Extension Nipple (compatible with Delany angle stops)	51.55
104543	M•DURA™ 3 1/4" Extension Nipple (compatible with Delany angle stops)	56.45
104544	M•DURA™ 3 3/4" Extension Nipple (compatible with Delany angle stops)	61.25
104545	M•DURA™ 4 1/4" Extension Nipple (compatible with Delany angle stops)	66.15
104546	M•DURA™ 2 1/8" Extension (standard) Nipple*	41.60
104547	M•DURA™ 2 1/2" Extension Nipple*	46.40
104548	M•DURA™ 3" Extension Nipple*	51.30
104549	M•DURA™ 3 1/2" Extension Nipple*	56.00
104550	M•DURA™ 4" Extension Nipple*	60.85
104551	M•DURA™ 4 1/2" Extension Nipple*	65.65
104552	M•DURA™ 5" Extension Nipple*	70.45
104553	M•DURA™ 5 1/2" Extension Nipple*	75.30
104554	M•DURA™ 6" Extension Nipple*	80.15
104555	M•DURA™ 1" Angle Stop	130.80
104556	M•DURA™ 3/4" Angle Stop	130.80
104557	M•DURA™ Angle Stop Repair Kit	24.75
104560	M•DURA™ Offset Flush Tube 22 1/2" x 1 1/2"	54.65
104561	M•DURA™ Cap Assembly	77.45
104563	M•DURA™ 3.5 gpf (13.2 lpf) Piston	81.45
104564	M•DURA™ 1.6 gpf (6.0 lpf) Piston	81.45
104565	M•DURA™ 1.28 gpf (4.8 lpf) Piston	81.45
104566	M•DURA™ 1.0 gpf (3.8 lpf) Piston	81.45
104567	M•DURA™ 0.5 gpf (1.9 lpf) Piston	81.45
104568	M•DURA™ 0.125 gpf (0.5 lpf) Piston	81.45
104569	M•DURA™ Handle Assembly	31.30
104570	M•DURA™ Vacuum Breaker Assembly	22.05
104571	M•DURA™ Body Nut	29.45
104572	M•DURA™ Angle Stop Replacement Cap	8.00
104578	M•DURA™ Flush Tube 8 1/2" x 1 1/2"	49.25
104579	M•DURA™ Flush Tube 8" x 1 1/4"	49.25
104580	M•DURA™ Flush Tube 8" x 1 3/4"	48.30
104581	M•DURA™ 1 1/2" Top Spud Assembly	49.25
104582	M•DURA™ 1 1/4" Top Spud Assembly	46.40
104583	M•DURA™ 3/4" Top Spud Assembly	40.60
104584	M•DURA™ Flush Extension Tube 24" x 3/4"	108.95
104585	M•DURA™ Flush Extension Tube 24" x 1 1/2"	140.70
104588	M•DURA™ Sweat Kit (1" supply) 3" length	36.50
104589	M•DURA™ Sweat Kit (1" supply) 6" length	50.75
104590	M•DURA™ Cap Assembly with 3.5 gpf Marking	33.40
104591	M•DURA™ Cap Assembly with 1.6 gpf Marking	33.40
104592	M•DURA™ Cap Assembly with 1.28 gpf Marking	33.40
104593	M•DURA™ Cap Assembly with 1.0 gpf Marking	33.40
104594	M•DURA™ Cap Assembly with 0.5 gpf Marking	33.40
104595	M•DURA™ Cap Assembly with 0.125 gpf Marking	33.40
104597	M•DURA™ Tail Piece and Interior Cap Tool	23.75

M•DURA™ Heavy-Duty Manual Flush Valves

COMMERCIAL



M•DURA™ Heavy-Duty Manual Urinal Flush Valves / 8312M Series

M•DURA™ Heavy-Duty Showering



M•DURA™ Modern Heavy-Duty Shower System / T9342 Series





M•DURA™ Heavy-Duty Showering

M•DURA™ An invigorating shower at every flow rate.

ENGINEERED TO ENHANCE THE SHOWER EXPERIENCE.

Our latest design maximizes performance and durability while offering a range of flow rate options. Available in LifeShine® Classic Brushed Nickel and Chrome.



-  Available in the standard flow rate—2.5 gpm (9.5 lpm)—as well as WaterSense®-certified flow rates of 1.75 gpm (6.6 lpm) and 1.5 gpm (5.7 lpm).
-  Water flows through an engineered-polymer channel for instant, consistent flow.
-  Conserves water without sacrificing performance.
-  All-metal design, ideal for heavy-use applications.
-  Set screw locks the showerhead to the arm for antitheft protection.

COMMERCIAL

MODEL NUMBER	LIST PRICE	CASE QTY
--------------	------------	----------

MODERN POSI-TEMP® PRESSURE-BALANCING SHOWER SYSTEM





- Posi-Temp® tub/shower system trim kit only
- **Valve not included**
- **Pair with a Posi-Temp® rough-in-valve* (choose from connection options found on page 443)**
- **Also requires a 3360 three-function transfer valve found on page 443**
- 1.5 gpm (5.7 lpm) max.
- 30" slide bar†
- Vandal-resistant head, arm and flange
- Handshower with non-positive pause function
- 69" double swivel hose
- Integral double check valves in handshower
- Drop ell

T9342EP15	609.30	1
------------------	--------	---



*The Posi-Temp and Moentrol® valves meet ASSE 1016 compliance requirements for controlling temperature fluctuations when paired with Moen Commercial showerheads and handshowers with flow rates as low as 1.5 gpm (5.7 lpm). † Slide bar is not a grab bar. Not to be used as support.

-  ADA compliant (excluding holders, slide bars and diverting tub spout)
-  WaterSense®  Water-saving

M•DURA™ Heavy-Duty Showering

	MODEL NUMBER	LIST PRICE	CASE QTY
MODERN POSI-TEMP® PRESSURE-BALANCING TUB/SHOWER SYSTEM WITH SLIDE BAR/GRAB BAR			



- Posi-Temp® tub/shower system trim kit only
- **Valve not included**
- **Pair with a Posi-Temp® rough-in-valve* (choose from connection options found on page 443)**
- **Also requires a 3360 three-function transfer valve found on page 443**
- 1.5 gpm (5.7 lpm) max.
- 24" slide bar/grab bar
- Vandal-resistant head, arm and flange
- Handshower with non-positive pause function
- 69" double swivel hose
- Integral double check valves in handshower
- Drop ell

T9342GBM15 670.30 1



POSI-TEMP® PRESSURE-BALANCING SHOWER SYSTEM			
--	--	--	--



- Posi-Temp® tub/shower system trim kit only
- **Valve not included**
- **Pair with a Posi-Temp® rough-in-valve* (choose from connection options found on page 443)**
- **Also requires a 3360 three-function transfer valve found on page 443**
- No volume control
- Adjustable temperature limit stop
- Vandal-resistant showerhead, arm and flange
- Handshower with non-positive pause function
- 2.5 gpm (9.5 lpm) max.
- 69" double swivel hose
- 30" slide bar†
- Integral double check valves in handshower
- Drop ell

T8342 425.50 1

- 1.5 gpm (5.7 lpm) max.

T8342EP15 425.50 1



*The Posi-Temp and Moentrol® valves meet ASSE 1016 compliance requirements for controlling temperature fluctuations when paired with Moen Commercial showerheads and handshowers with flow rates as low as 1.5 gpm (5.7 lpm). † Slide bar is not a grab bar. Not to be used as support.

- ADA compliant (excluding holders, slide bars and diverting tub spout)
- WaterSense® Water-saving

COMMERCIAL

M•DURA™ Heavy-Duty Showering

MODEL NUMBER	LIST PRICE	CASE QTY
--------------	------------	----------

POSI-TEMP® PRESSURE-BALANCING TUB/SHOWER SYSTEM			
---	--	--	--



- Posi-Temp® tub/shower system trim kit only
- **Valve not included**
- **Pair with a Posi-Temp® rough-in-valve* (choose from connection options found on page 443)**
- **Also requires a 3360 three-function transfer valve found on page 443**
- Adjustable temperature limit stop
- Vandal-resistant showerhead, arm and flange
- Handshower with non-positive pause function
- 2.5 gpm (9.5 lpm) max.
- 69" double swivel hose
- 30" slide bar†
- Tub filler spout
- Integral double check valves in handshower
- Drop ell

T8341

416.35

1



MODERN POSI-TEMP® PRESSURE-BALANCING HANDSHOWER SYSTEM			
--	--	--	--



- Posi-Temp® shower system trim kit only
- **Valve not included**
- **Pair with a Posi-Temp® rough-in-valve* (choose from connection options found on page 443)**
- 1.5 gpm (5.7 lpm) max.
- 30" slide bar†
- Handshower with non-positive pause function
- Integral double check valves in handshower
- Drop ell

T9346EP15

536.80

4



*The Posi-Temp and Moentrol® valves meet ASSE 1016 compliance requirements for controlling temperature fluctuations when paired with Moen Commercial showerheads and handshowers with flow rates as low as 1.5 gpm (5.7 lpm). † Slide bar is not a grab bar. Not to be used as support.

ADA compliant (excluding holders, slide bars and diverting tub spout)

WaterSense® Water-saving

M•DURA™ Heavy-Duty Showering

	MODEL NUMBER	LIST PRICE	CASE QTY
MODERN POSI-TEMP® PRESSURE-BALANCING HANDSHOWER SYSTEM WITH SLIDE BAR/GRAB BAR			



- Posi-Temp® shower system trim kit only
- **Valve not included**
- **Pair with a Posi-Temp® rough-in-valve* (choose from connection options found on page 443)**
- 1.5 gpm (5.7 lpm) max.
- 24" slide bar/grab bar
- Handshower with non-positive pause function
- Integral double check valves in handshower
- Drop ell

T9346GBM15 590.45 1



POSI-TEMP® PRESSURE-BALANCING HANDSHOWER SYSTEM			
--	--	--	--



- Posi-Temp® shower system trim kit only
- **Valve not included**
- **Pair with a Posi-Temp® rough-in-valve* (choose from connection options found on page 443)**
- No volume control
- Adjustable temperature limit stop
- Handshower with non-positive pause function
- 1.5 gpm (5.7 lpm) max.
- 69" double swivel hose
- 30" slide bar†
- Integral double check valves in handshower
- Drop ell

T8346 352.00 4



• 1.5 gpm (5.7 lpm) max. **T8346EP15** 352.00 4



COMMERCIAL

*The Posi-Temp and Moentrol® valves meet ASSE 1016 compliance requirements for controlling temperature fluctuations when paired with Moen Commercial showerheads and handshowers with flow rates as low as 1.5 gpm (5.7 lpm). † Slide bar is not a grab bar. Not to be used as support.

ADA compliant (excluding holders, slide bars and diverting tub spout)
 WaterSense® Water-saving

M•DURA™ Heavy-Duty Showering

MODEL NUMBER LIST PRICE CASE QTY

MODERN POSI-TEMP® PRESSURE-BALANCING TUB/SHOWER



- Single handle Posi-Temp® tub/shower system trim kit only
- **Valve not included**
- **Pair with a Posi-Temp® rough-in-valve* (choose from connection options found on page 443)**
- 2.5 gpm (9.5 lpm) max
- Vandal-resistant showerhead, arm and flange
- Adjustable temperature limit stop
- Diverter tub spout

T9389 204.60 3



- 1.5 gpm (5.7 lpm) max.

T9389EP15 204.60 3



COMMERCIAL

POSI-TEMP® PRESSURE-BALANCING TUB/SHOWER



- Single handle Posi-Temp® tub/shower system trim kit only
- **Valve not included**
- **Pair with a Posi-Temp® rough-in-valve* (choose from connection options found on page 443)**
- No volume control
- Vandal-resistant showerhead, arm and flange
- Adjustable temperature limit stop
- Diverter tub spout
- 2.5 gpm (9.5 lpm) max.

T8389 129.30 3



- 1.5 gpm (5.7 lpm) max.

T8389EP15 129.30 3



T8389EP15CBN 245.85 3

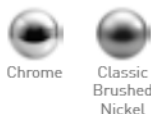

Chrome

Classic Brushed Nickel

Classic Brushed Nickel available on select models ending in **CBN**.

*The Posi-Temp and Moentrol® valves meet ASSE 1016 compliance requirements for controlling temperature fluctuations when paired with Moen Commercial showerheads and handshowers with flow rates as low as 1.5 gpm (5.7 lpm). † Slide bar is not a grab bar. Not to be used as support.

ADA compliant (excluding holders, slide bars and diverting tub spout)
 WaterSense® Water-saving

M•DURA™ Heavy-Duty Showering

	MODEL NUMBER	LIST PRICE	CASE QTY	
MODERN POSI-TEMP® PRESSURE-BALANCING SHOWER				
	<ul style="list-style-type: none"> • Single-handle Posi-Temp® shower system trim kit only • Valve not included • Pair with a Posi-Temp® rough-in-valve* (choose from connection options found on page 443) • 2.5 gpm (9.5 lpm) max. • Vandal-resistant showerhead, arm and flange • Adjustable temperature limit stop 	T9375	160.80	3
	<ul style="list-style-type: none"> • 1.5 gpm (5.7 lpm) max. 	T9375EP15	160.80	3

POSI-TEMP® PRESSURE-BALANCING SHOWER				
	<ul style="list-style-type: none"> • Single handle Posi-Temp® shower system trim kit only • Valve not included • Pair with a Posi-Temp® rough-in-valve* (choose from connection options found on page 443) <p>No volume control</p> <ul style="list-style-type: none"> • Vandal-resistant showerhead, arm and flange • Adjustable temperature limit stop • 2.5 gpm (9.5 lpm) max. 	T8375	93.60	3
	<ul style="list-style-type: none"> • 1.5 gpm (5.7 lpm) max. 	T8375EP15	93.60	3
		T8375EP15CBN	184.45	3

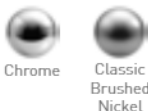



Chrome Classic Brushed Nickel

COMMERCIAL

 Classic Brushed Nickel available on select models ending in **CBN**.

*The Posi-Temp and Moentrol® valves meet ASSE 1016 compliance requirements for controlling temperature fluctuations when paired with Moen Commercial showerheads and handshowers with flow rates as low as 1.5 gpm (5.7 lpm). † Slide bar is not a grab bar. Not to be used as support.

-  ADA compliant (excluding holders, slide bars and diverting tub spout)
-  WaterSense®  Water-saving

M•DURA™ Heavy-Duty Showering

MODEL NUMBER LIST PRICE CASE QTY

24" SLIDE BAR/GRAB BAR HANDSHOWER SYSTEM WITHOUT VALVE



- Handshower with non-positive shutoff
- 1.5 gpm (5.7 lpm) max.
- 1 1/2" x 24" stainless steel ADA compliant slide bar/grab bar
- 69" double swivel metal hose
- Integral double check valves in handshower
- Drop ell

52224GBM15 375.40 3



- 2.5 gpm (9.5 lpm) max.



52224GBM25 375.40 3



COMMERCIAL

 Classic Brushed Nickel available on select models ending in **CBN**.

*The Posi-Temp and Moentrol® valves meet ASSE 1016 compliance requirements for controlling temperature fluctuations when paired with Moen Commercial showerheads and handshowers with flow rates as low as 1.5 gpm (5.7 lpm). † Slide bar is not a grab bar. Not to be used as support.

-  ADA compliant (excluding holders, slide bars and diverting tub spout)
-  WaterSense®  Water-saving

M•DURA™ Heavy-Duty Showering

36" SLIDE BAR/GRAB BAR HANDSHOWER SYSTEM WITHOUT VALVE

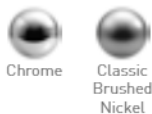

- Handshower with non-positive shutoff
- 1.5 gpm (5.7 lpm) max.
- 1 1/2" x 36" stainless steel ADA compliant slide bar/grab bar
- 69" double swivel metal hose
- Integral double check valves in handshower
- Drop ell



MODEL NUMBER	LIST PRICE	CASE QTY
52236GBM15	410.70	3

- 2.5 gpm (9.5 lpm) max.



52236GBM25	410.70	3
-------------------	--------	---

HANDSHOWER SYSTEM WITHOUT VALVE

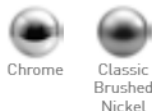

- Handshower with non-positive pause function
- 2.5 gpm (9.5 lpm) max.
- 69" double swivel hose
- 30" slide bar†
- Integral double check valves in handshower
- Drop ell



52710	307.05	6
--------------	--------	---

- 1.5 gpm (5.7 lpm) max.





52710EP15	307.05	6
------------------	--------	---

52710EP15CBN	714.15	6
---------------------	--------	---

COMMERCIAL

 Classic Brushed Nickel available on select models ending in **CBN**.

*The Posi-Temp and Moentrol® valves meet ASSE 1016 compliance requirements for controlling temperature fluctuations when paired with Moen Commercial showerheads and handshowers with flow rates as low as 1.5 gpm (5.7 lpm). † Slide bar is not a grab bar. Not to be used as support.

-  ADA compliant (excluding holders, slide bars and diverting tub spout)
-  WaterSense®  Water-saving

M•DURA™ Heavy-Duty Showering

	MODEL NUMBER	LIST PRICE	CASE QTY
--	--------------	------------	----------

MODERN HANDSHOWER



- Handshower with non-positive pause function
- Single-function spray pattern
- 2.5 gpm (9.5 lpm) max.
- Easy clean nozzles
- Integral double check valves in handshower

9349

140.00

6



- 1.5 gpm (5.7 lpm) max.

9349EP15

140.00

6



HANDSHOWER



- Handshower with non-positive pause function
- Single-function spray pattern
- 2.5 gpm (9.5 lpm) max.
- Easy clean nozzles
- Integral double check valves in handshower

8349

87.80

6

8349CBN

148.65

6



- 1.5 gpm (5.7 lpm) max.

8349EP15

87.80

6



8349EP15CBN

148.65

6

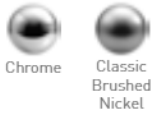

Chrome

Classic
Brushed
Nickel

SHOWER ARM AND FLANGE



- All metal shower arm and flange

A705CBN

92.60

12

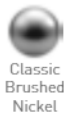



Classic
Brushed
Nickel





Classic Brushed Nickel available on select models ending in CBN.

ADA compliant (excluding holders, slide bars and diverting tub spout)



WaterSense® Water-saving



M•DURA™ Heavy-Duty Showering

	MODEL NUMBER	LIST PRICE	CASE QTY	
MODERN SHOWERHEAD				
	<ul style="list-style-type: none"> • Single-function spray pattern • 2.5 gpm (9.5 lpm) max. • 1/2" IPS connection • Self-cleaning spray formers 	9263	95.15	12
	<ul style="list-style-type: none"> • 1.5 gpm (5.7 lpm) max.  	9263EP15	95.15	12

VANDAL-RESISTANT SHOWERHEAD				
	<ul style="list-style-type: none"> • Single-function spray pattern • 2.5 gpm (9.5 lpm) max. • 1/2" IPS connection • Self-cleaning spray formers 	5263	69.40	12
	<ul style="list-style-type: none"> • 1.5 gpm (5.7 lpm) max.  	5263EP15	69.40	12
	<ul style="list-style-type: none"> • 2.5 gpm (9.5 lpm) max. • 1/2" IPS connection • Self-cleaning spray formers 	5263CBN	125.15	12
	<ul style="list-style-type: none"> • 1.5 gpm (5.7 lpm) max.  	5263EP15CBN	125.15	12

Chrome Classic Brushed Nickel

VANDAL-RESISTANT SHOWERHEAD				
	<ul style="list-style-type: none"> • Single-function spray pattern • 1.5 gpm (5.7 lpm) max. • 1/2" IPS connection • Self-cleaning spray formers 	52716EP15	85.85	20
	 			

VANDAL-RESISTANT SHOWERHEAD				
	<ul style="list-style-type: none"> • Single-function spray pattern • 2.5 gpm (9.5 lpm) max. • 1/2" IPS connection • Adjustable spray angle • Mounting hardware included 	8290	161.10	12
	<ul style="list-style-type: none"> • 1.5 gpm (5.7 lpm) max.  	8290EP15	161.10	12

COMMERCIAL

 Classic Brushed Nickel available on select models ending in **CBN**.

M•DURA™ Heavy-Duty Showering

MODEL NUMBER LIST PRICE CASE QTY

MODERN POSI-TEMP® PRESSURE-BALANCING VALVE TRIM



- Single-handle trim kit only
- **Valve not included**
- **Pair with a Posi-Temp® rough-in-valve* (choose from connection options found on page 443)**
- No volume control
- Adjustable temperature limit stop

T9370 128.50 3



POSI-TEMP® PRESSURE-BALANCING VALVE TRIM



- Single-handle trim kit only
- **Valve not included**
- **Pair with a Posi-Temp® rough-in-valve* (choose from connection options found on page 443)**
- No volume control
- Adjustable temperature limit stop

T8370 49.75 3

T8370CBN 126.85 3

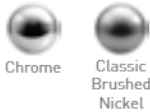

Chrome Classic Brushed Nickel

MOENTROL® PRESSURE-BALANCING VALVE TRIM



- Single-handle trim kit only
- **Valve (found on page 117) not included**
- **Pair with a 3570 or 3520 Moentrol® valve***
- Volume control
- Adjustable temperature limit stop
- Push/Pull operation

T8350 66.35 3

T8350CBN 174.05 3





 Classic Brushed Nickel available on select models ending in **CBN**.

*The Posi-Temp and Moentrol® valves meet ASSE 1016 compliance requirements for controlling temperature fluctuations when paired with Moen Commercial showerheads and handshowers with flow rates as low as 1.5 gpm [5.7 lpm].

 ADA compliant (excluding holders, slide bars and diverting tub spout)

M•DURA™ Heavy-Duty Showering

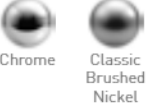
	MODEL NUMBER	LIST PRICE	CASE QTY	
MODERN THREE-FUNCTION TRANSFER VALVE TRIM				
	<ul style="list-style-type: none"> • Three function transfer valve trim kit only • Valve not included • Pair with a 3360 three-function transfer valve found on page 443 • Valve operates three distinct functions, but can be plumbed in for two functions 	T9360	164.50	3
				

	MODEL NUMBER	LIST PRICE	CASE QTY	
THREE-FUNCTION TRANSFER VALVE TRIM				
	<ul style="list-style-type: none"> • Three-function transfer valve trim kit only • Valve not included • Pair with the 3360 three-function transfer valve found on page 443 • Valve operates three distinct functions, but can be plumbed for two distinct functions 	T8360	58.30	3
	<ul style="list-style-type: none"> • Chrome • Classic Brushed Nickel 	T8360CBN	138.90	3
				

TUB/SHOWER ACCESSORIES			
Part Number	Finish	Description	List Price
15856	Chrome	Diverter tub spout, 1/2" slip fit, vandal-resistant	58.40
15856CBN	Classic Brushed Nickel		117.55
100686	Chrome	Slide bar swivel bracket for handshower	59.75
101629	Chrome	30" adjustable slide bar with attaching hardware (This bar is not a grab bar. Not to be used for support.)	190.65
104414	Chrome	Wall-mounted bracket for handshower	75.90
52711	---	Slide bar/Grab bar bracket- 1-1/2" diameter	34.60
A725	Chrome	Drop ell	63.00
A725CBN	Classic Brushed Nickel		89.85
A726	Chrome	69" metal hose (vacuum breaker sold separately)	92.40
A780	Chrome	80" metal hose (vacuum breaker sold separately)	133.40
52703	Chrome	Optional vacuum breaker for handshower 1/2" IPS connections	78.85
A714ST	Classic Brushed Nickel	Optional vacuum breaker for handshower 1/2" IPS connections	106.25

 Classic Brushed Nickel available on select models ending in **CBN**.

*The Posi-Temp and Moentrol® valves meet ASSE 1016 compliance requirements for controlling temperature fluctuations when paired with Moen Commercial showerheads and handshowers with flow rates as low as 1.5 gpm [5.7 lpm].

 ADA compliant (excluding holders, slide bars and diverting tub spout)

Tub/Shower Valves

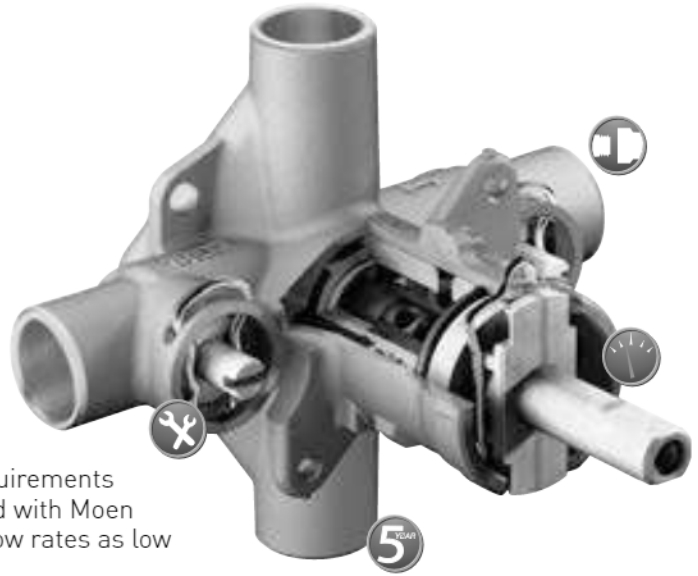

Faster, Easier Maintenance: Integral Stops
Shut-off water supply at the valve for quick and easy maintenance.

Safe, Consistent Operation: Graphite Composite Pressure-Balancing Design
Posi-Temp® valves meet ASSE 1016 compliance requirements for controlling temperature fluctuations when paired with Moen Commercial showerheads and handshowers with flow rates as low as 1.5 gpm (5.7 lpm).

Installation Flexibility: Inlet Connection Options
For faster, easier install, choose from CC, IPS, PEX and PEX expansion inlet connections



CC



IPS



PEX~



PEX~
Expansion

Worry-Free Quality:
Best-in-Class Five-Year Limited Warranty

COMMERCIAL

MODEL NUMBER LIST PRICE CASE QTY

POSI-TEMP® CARTRIDGE



- Single-handle replacement cartridge
- Graphite composite pressure-balancing spool design

1222





117.60

18

~Please refer to bulk catalogue.

Order your valve to match your supply lines for quick, hassle-free installation.

Choose from CC, IPS, PEX~ and PEX~ expansion inlet connection options.

		MODEL NUMBER	LIST PRICE	CASE QTY
POSI-TEMP® ROUGH-IN VALVE				
	<ul style="list-style-type: none"> • M•PACT® Common Valve System • 1/2" CC connections without integral stops • 4-port cycling valve • Adjustable temperature limit stop • Graphite composite pressure-balancing spool design 	2520*	152.20	6
POSI-TEMP® ROUGH-IN VALVE				
	<ul style="list-style-type: none"> • M•PACT® Common Valve System • 1/2" CC connections with integral stops • 4-port cycling valve • Adjustable temperature limit stop • Graphite composite pressure-balancing spool design 	2570*	194.75	6
POSI-TEMP® ROUGH-IN VALVE				
	<ul style="list-style-type: none"> • M•PACT® Common Valve System • 1/2" IPS connections with integral stops • 4-port cycling valve • Adjustable temperature limit stop • Graphite composite pressure-balancing spool design 	2590*	194.75	6
THREE-FUNCTION TRANSFER VALVE				
	<ul style="list-style-type: none"> • 1/2" CC connections with integral stops • Three distinct functions • Ceramic disk cartridge 	3360	216.60	6
HIGH-FLOW THERMOSTATIC MIXING VALVE FOR ROMAN TUBS				
	<ul style="list-style-type: none"> • 1/2" FIP (3/8" compression adapters) • Listed to ASSE Standard 1070 • Max. flow rate at 45 psi = 10 gpm • Roman tub application 	104465	223.55	12

COMMERCIAL

*The Posi-Temp and Moentrol® valves meet ASSE 1016 compliance requirements for controlling temperature fluctuations when paired with Moen Commercial showerheads and handshowers with flow rates as low as 1.5 gpm (5.7 lpm).

~Please refer to bulk catalogue.

PARTNERING TO PROTECT THE ENVIRONMENT



Look for the WaterSense® logo to identify water-efficient Moen® faucets that meet WaterSense® criteria. As of Jan. 1, 2009, all Moen® lavatory faucet SKUs* have been manufactured with a 1.5 gpm aerator that is certified to meet WaterSense® criteria. The packaging label clearly indicates the WaterSense® logo and the 1.5 gpm flow rate. If the product you receive does not have the qualifying label markings, a 1.5 gpm replacement aerator can be ordered by calling 1-800-465-6130.

*Excluding all bathtub spouts and some commercial faucets and showerheads



The U.S. Green Building Council® developed the Leadership in Energy and Environmental Design (LEED®) Green Building Rating System as a nationally accepted benchmark for measuring and documenting green building practices.



The Green UPC® symbol indicates that this product has been certified by the International Association of Plumbing and Mechanical Officials (IAPMO) to reduce water consumption by at least 20% when compared to standard flow rates.

All Moen® lavatory and kitchen faucets meet NSF 372 requirements.

Shower Valve Flow Rates

Flow Rate vs. Flowing Inlet Pressure of Moen Showering Valves (Unrestricted)

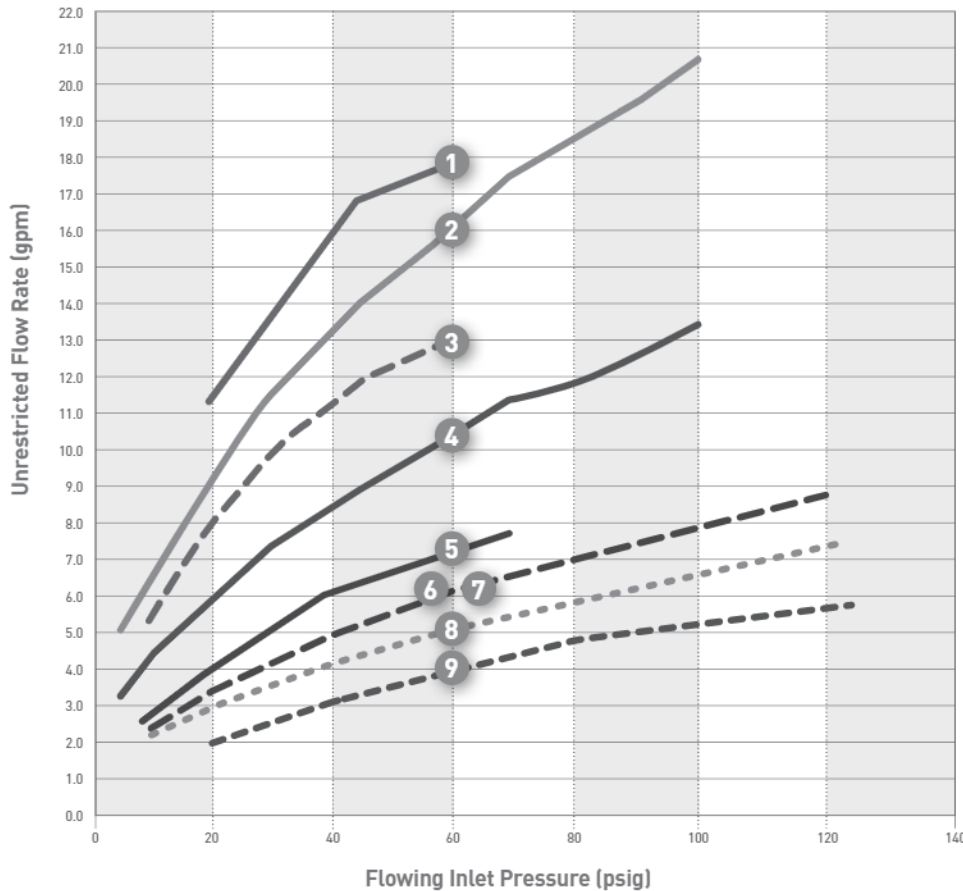

1. **¾" ExactTemp®**
S3371 ¾" ExactTemp: 18.0 gpm
2. **U by Moen™ Shower – Four-Outlet**
S3104 Four-Outlet: 16.0 gpm
3. **Volume Control**
S3600 Volume Control: 13+ gpm
4. **U by Moen™ Shower – Two-Outlet**
S3102 Two-Outlet: 10.3 gpm
5. **Moentrol® Tub Port**
Moentrol 3520/3510/3570
Flow at Tub: 7.2 gpm
6. **Moentrol Shower Port**
Moentrol 3520/3510/3570
Flow at Shower: 6.3 gpm
7. **Posi-Temp® Tub Port**
Posi-Temp 2520/2510/2570/2590
Flow at Tub: 6.3 gpm
8. **Moentrol Two Outlets**
Moentrol 3320/3330/3350
Two-Outlets: 5.2 gpm
9. **Posi-Temp Shower Port**
Posi-Temp 2520/2510/2570/2590
Shower: 4.0 gpm

Shower Spa Installation Recommendations

Graph Line	Valve	Flow Rate through shower port (gpm) @ 20 PSI	Flow Rate through shower port (gpm) @ 40 PSI	Flow Rate through shower port (gpm) @ 60 PSI	Use with 2- or 3-function transfer	Maximum Components
1	¾" ExactTemp® S3371	11.4	15.7	18.0	No	4 components: Any combination of showerheads, handshowers and body sprays (4 max)
2	U by Moen™ Four-Outlet S3104	9.0	13.0	16.0	No	4 components: Any combination of showerheads, handshowers and body sprays (4 max)
4	U by Moen Two-Outlet S3102	6.0	8.5	10.0	No	Showerhead, handshower or showerhead, 2 body sprays
6	Moentrol® 3520, 3510, 3570	3.5	5.0	6.3	Yes	Showerhead, handshower
8	Moentrol Two Outlets 3320, 3330, 3350	3.0*	4.2*	5.2*	No	Showerhead, handshower or showerhead, 2 body sprays
9	Posi-Temp 2520, 2510, 2570, 2580, 2590	2.1	3.2	4.0	Yes	Showerhead, handshower

* 3-Function Moentrol flow is the total flow when used in the shared mode.



Pricing effective February 18, 2019.

Although descriptions are believed correct at publication approval, accuracy cannot be guaranteed.

Moen reserves the right to make product specification changes from time to time, without notice or obligation, and to change or discontinue models.

Connect with us:
moen.com/social

U.S. Headquarters:
Moen Incorporated
25300 Al Moen Drive, North Olmsted, OH
44070-8022

Canada Headquarters:
Moen
2816 Bristol Circle, Oakville, Ontario
L6H 5S7

Visit our web site at: www.moen.ca

1-800-BUY-MOEN

1-800-465-6130